

## RD7100™

UTILITY CABLE AND PIPE LOCATOR RANGE

90/UG103INT/01 ISSUE 1 09/2015





# Preface

## About this guide

**CAUTION: This guide provides basic operating instructions for the RD7100 locator and transmitter. It also contains important safety information and guidelines and as such should be read in its entirety before attempting to operate the RD7100 locator and transmitter.**

This guide is intended as a quick reference guide only. For detailed instructions, including the use of accessories, help with eCert™, CALSafe™ and Usage-Logging please refer to the RD7100 locator Operation Manual and RD Manager™ manuals, which are available for download from [www.radiodetection.com](http://www.radiodetection.com).

The online User Manual library also contains links to the SurveyCERT+ and RD Manager manuals.

Certificates of conformity for the RD7100 locators and Tx transmitter ranges can be found at [www.radiodetection.com](http://www.radiodetection.com).

**⚠ WARNING! Direct connection to live conductors is POTENTIALLY LETHAL. Direct connections to live conductors should be attempted by fully qualified personnel only using the relevant products that allow connections to energized lines.**

**⚠ WARNING! The transmitter is capable of outputting potentially lethal voltages. Take care when applying signals to any pipe or cable and be sure to notify other technicians who may be working on the line.**

**⚠ WARNING! Reduce audio level before using headphones to avoid damaging your hearing.**

**⚠ WARNING! This equipment is NOT approved for use in areas where hazardous gases may be present.**

**⚠ WARNING! When using the transmitter, switch off the unit and disconnect cables before removing the battery pack.**

**⚠ WARNING! The RD7100 locator will detect most buried conductors but there are some objects that do not radiate any detectable signal. The RD7100, or any other electromagnetic locator, cannot detect these objects so proceed with caution. There are also some live cables which the RD7100 will not be able to detect in Power mode. The RD7100 does not indicate whether a signal is from a single cable or from several in close proximity.**

**⚠ WARNING! Batteries can get hot after prolonged use at full output power. Take care while replacing or handling batteries.**

## 3 Year Extended Warranty

RD7100 locators and transmitters are covered by a 1 year warranty as standard. Customers can extend their warranty period to a total of 3 years by registering their products within 3 months of purchase.

Registration is carried out using the RD Manager PC software which can be downloaded from the Radiodetection website. Visit [www.radiodetection.com/RDManager](http://www.radiodetection.com/RDManager).

You can also register your product(s) by sending an email to [rd-support@spx.com](mailto:rd-support@spx.com), including the following details:

- Serial number of each product to be registered
- Date of purchase
- Company name & address, including country
- Contact name, email address & telephone number
- Country of residence.

From time to time Radiodetection may release new software to improve the performance or add new functionality to its products. By registering, users will benefit from email alerts advising about new software and special offers related to its product range.

Users can opt-out at any time from receiving software and technical notifications, or just from receiving marketing material by contacting Radiodetection.

## eCert and Self-Test

The RD7100 locator is safety equipment which should be regularly checked to ensure its correct operation.

eCert provides a thorough test of the RD7100's locating circuitry, and supplies a Radiodetection Calibration Certificate when a positive test result is obtained.

To run an eCert, the locator should be connected to an internet-enabled PC on which the RD Manager software is installed.

Refer to the RD Manager operation manual for further details. Additional purchase may be required.

RD7100 locators incorporate an Enhanced Self-Test feature. In addition to the typical checks for display and power functions, the RD7100 locator applies test signals to its locating circuitry during a Self-Test to check accuracy and performance.

We recommend that a self-test is run at least weekly, or before each use.

# RD7 100 locator

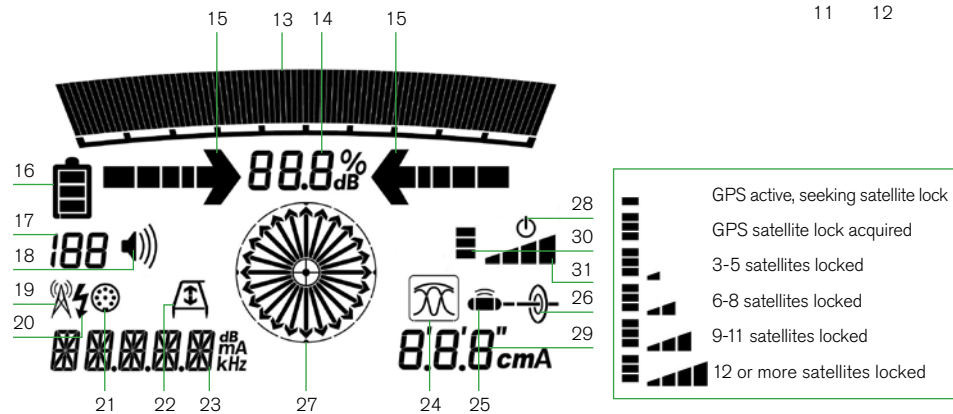
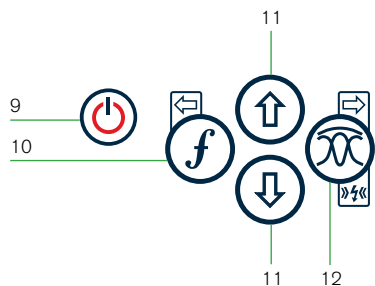

## Locator features

1. Keypad
2. LCD with auto backlight.
3. Speaker.
4. Battery compartment.
5. Optional Lithium-Ion battery pack.
6. Accessory connector.
7. Headphone connector.
8. USB port (inside battery compartment).
25. Sonde icon: Indicates that a sonde signal source is selected.
26. Line icon: Indicates that a line signal source is selected.
27. Compass: Shows the orientation of the located cable or sonde relative to the locator.
28. Transmitter standby indicator.
29. Depth readout.

## Locator keypad

9. Power key.
10. Frequency key.
11. Up and down arrows.
12. Antenna key.

## Locator screen icons

13. Signal strength bargraph with peak marker.
14. Signal strength readout.
15. Null / Proportional Guidance arrows.
16. Battery level.
17. Sensitivity readout
18. Volume level.
19. Radio Mode icon.
20. Power Mode icon.
21. Accessory / Measurement icon.
22. A-Frame icon.
23. Frequency / current / menu readout.
24. Antenna modes icon:  
Indicates antenna mode election:  
Peak / Peak+ / Null / Guidance.

# Tx-1, Tx-5 and Tx-10 transmitters

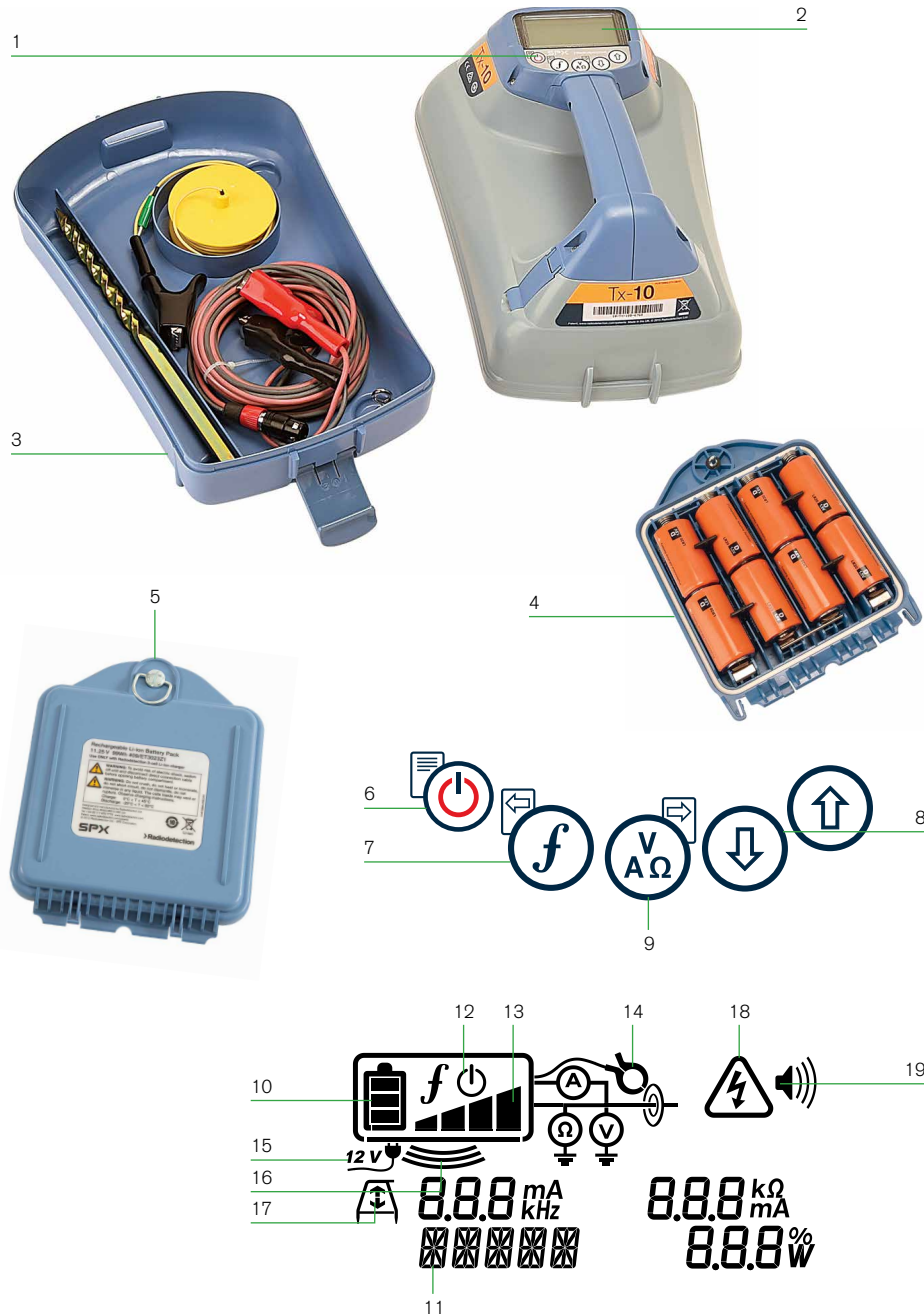

## Transmitter features

1. Keypad.
2. LCD.
3. Removable accessory tray.
4. D-cell battery tray.
5. Optional Lithium-Ion battery pack.

## Transmitter keypad

6. Power key.
7. Frequency key.
8. Up and down arrows.
9. Measure key.

## Transmitter screen icons





10. Battery level indicator.
11. Operation mode readout.
12. Standby icon.
13. Output level indicator.
14. Clamp icon: Indicates when a signal clamp or other accessory is connected.
15. DC Power connected indicator.
16. Induction mode indicator.
17. A-Frame: Indicates when the transmitter is in Fault-Find Mode.
18. Voltage warning indicator: Indicates that the transmitter is outputting potentially hazardous voltage levels.
19. Volume level indicator.









## Keypad actions and shortcuts



Switch the locator or transmitter on by pressing the  key. Once powered up, the keys function as follows:

### Locator keys

| KEY  | ● SHORT PRESS   | ▬ LONG PRESS   |
|--|---|--|
|  | Enter the menu.   | Switch power off.  |
|  | Scroll through locate frequencies from low to high.   | -  |
|  | When using active frequencies:<br>Toggles Peak, Peak+, Null, and Guidance antenna modes.<br><br>PL & PLG models in Power Mode:<br>Scrolls through Power Filters™ for improved discrimination of parallel or strong power signals. | In Peak+ antenna mode:<br>Switch between Guidance and Null arrows. |
|  | Increase and decrease gain.<br>RD7100 automatically sets gain to mid-point when pressed.  | Rapidly increase and decrease gain steps in 1dB increments.        |

### Transmitter keys

| KEY  | ● SHORT PRESS   | ▬ LONG PRESS  |
|--|---|---|
|    | Enter the menu.   | Switch Power off.   |
|  | Scroll through locate frequencies from low to high.                             | -   |
|  | Take voltage and impedance measurements using the currently selected frequency. | Take voltage and impedance measurements at a standardized frequency.  |
|  | Adjusts the output signal.  | Select standby  / maximum standard power  . |

Tip: to scroll through frequencies from high to low, hold  while pressing the  button (applies to both locators and transmitters).

## Before you begin

### IMPORTANT!

This guide is intended to be a quick reference guide. We recommend you read the full operation manual before you attempt to operate the RD7100 locator.

### First use

The RD7100 locators and transmitters can be powered by D-cell alkaline batteries, D-cell NiMH batteries, or by an accessory Lithium-Ion (Li-Ion) battery pack.

To fit the D cell batteries in the locator, open the battery compartment and insert two D-Cell Alkaline or NiMH batteries, taking care to align the positive (+) and negative (-) terminals as indicated.

To fit the D cell batteries in the transmitter, unlatch the accessory tray. The battery compartment is located underneath the transmitter body. Use the turnkey to unlatch the battery compartment. Insert eight D-Cell Alkaline or NiMH batteries, taking care to align the positive (+) and negative (-) terminals as indicated.

Alternatively, you can power the transmitter from a mains or vehicle power source using a Radiodetection supplied optional accessory adapter.

### Rechargeable battery packs

Lithium-Ion battery packs are available for both locators and transmitters, providing superior performance over traditional alkaline batteries. To fit these rechargeable packs, follow the instructions provided with each pack.

### Checking your system software version

If you wish to check which version of software is running on your locator, press and hold the  key when switching the locator on. This information may be asked for when contacting Radiodetection or your local representative for technical support.

Transmitters automatically show their software version on startup.





### System setup

It is important that you set up the system according to regional / operational requirements and your personal preferences before you conduct your first survey. You can set the system up using the menus as described below.









## Setting up your system

The RD7100 locator and transmitter menus allow you to select or change system options. Once entered, the menu is navigated using the arrow keys. Navigation is consistent on both the transmitter and the locator. When in the menu, most on-screen icons will temporarily disappear and the menu options will appear in the bottom left-hand corner of the display. The right arrow enters a submenu and the left arrow returns to the previous menu.



Note that when browsing the locator menu, the  and  keys act as left and right arrows. When browsing the transmitter menu, the  and  keys act as left and right arrows.

### To navigate menus:

1. Press the  key to enter the menu.
2. Use the  or  keys to scroll through the menu options.
3. Press the  key to enter the option's submenu.
4. Use the  or  keys to scroll through the submenu options.
5. Press the  key to confirm a selection and return to the previous menu.
6. Press the  key to return to the main operation screen.

**NOTE:** When you select an option and press the  key, the option will be enabled automatically.

## Locator menu options

- VOL: Adjust the speaker volume from 0 (mute) to 3 (loudest).
- GPS: Enable or disable the internal GPS module and enable/disable SBAS GPS augmentation (GPS models only).
- UNITS: Select metric or imperial units.
- INFO: Run a Self-Test, display the date of the most recent service recalibration (M CAL) or the most recent eCert calibration.
- LANG: Select menu language.
- POWER: Select local power network frequency: 50 or 60Hz.
- ANT: Enable or disable any antenna mode with the exception of Peak.
- FREQ: Enable or disable individual frequencies.
- ALERT: Enable or disable StrikeAlert™.
- BATT: Set battery type: Alkaline or NiMH. Li-Ion auto-selects when connected.
- ARROW: Select Null or proportional Guidance arrows in Peak+ mode
- COMP: Enable or disable display of the Compass feature.

## Transmitter menu options







- VOL: Adjust the speaker volume from 0 (mute) to 3 (loudest).
- FREQ: Enable or disable individual frequencies.
- BOOST: Boost transmitter output for a specified period of time (in minutes).
- LANG: Select menu language.
- OPT F: Run SideStep<sup>auto</sup>™ to auto-select a locate frequency for the connected utility.
- BATT: Set battery type: ALK, NiMH or Li-Ion and enable / disable Eco mode.
- MAX P: Set the transmitter to output its maximum wattage.

- MODEL: Match the transmitter setting to the model of your locator.
- MAX V: Set the output voltage to maximum (90V).

## Examples of using the menu, selecting options and making changes:

### Locator mains power frequency







To select the correct frequency (50 or 60Hz) for your country or region's power supply:

1. Press the  key to enter the menu.
2. Scroll to the POWER menu using the  or  keys.
3. Press the  key to enter the POWER menu.
4. Use the  or  keys to select the correct mains frequency.
5. Press the  key twice to accept your selection and return to the main operation screen.

### Batteries











It is important to set the system to match the currently installed battery type to ensure optimal performance and correct battery level indication.

To set your battery type:

1. Press the  key to enter the menu.
2. Scroll to the BATT menu using the  or  arrows.
3. Press the  key (locator) or the  key (transmitter) to enter the BATT menu.
4. Scroll up or down to select the correct battery type (Alkaline, Nickel-metal Hydride or Lithium-Ion). Lithium-Ion is automatically selected when a Li-Ion pack is connected to a locator.
5. Press the  key twice to accept your selection and return to the main operation screen.

### Transmitter Eco Mode

When using alkaline batteries, Eco mode can be selected to maximize run time. When Eco mode is selected the transmitter automatically reduces its maximum power output as battery levels run low. Eco mode is switched off by default. To Enable Eco Mode:

1. Press the  key to enter the menu.
2. Scroll to the BATT menu using the  or  arrows.
3. Press the  key to enter the BATT menu.
4. Select the ALK Battery type using the  or  arrows.
5. Press the  key to enter the ECO sub menu
6. Select ECO using the  or  arrows.
7. Press the  key three times to accept your selection and return to the main operation screen.

## Locating pipes and cables





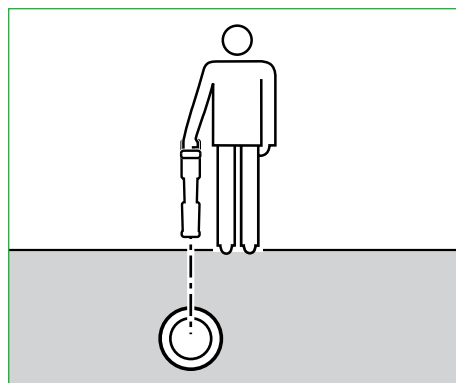



For more detailed descriptions of using the locator and transmitter, and for detailed locate techniques, refer to the Operation Manual.

The RD7100 locator is designed to operate with the 'blade' of the locator perpendicular to the path of the cable or pipe being located.







### Running a Self-Test

We recommend that a Self-Test is run at least weekly, or before each use. As the Self-Test tests the integrity of the locate circuitry, it is important that it is carried out away from larger metallic object such as vehicles, or strong electrical signals. To run a Self-Test:

1. Press the  key to enter the menu.
2. Scroll to the INFO menu using the  or  arrows.
3. Press the  key to enter the INFO menu.
4. Select TEST using the  or  arrows.
5. Press the  key to select YES
6. Press the  key to begin the Self-Test
7. Once the Self-Test is completed, the result (PASS or FAIL) will be displayed.
8. Restart the locator using the  key

### SideStepauto™

The transmitter can be used to recommend a general-purpose locate frequency for the intended locate task by measuring the impedance of the target cable or pipe. To run SideStepauto™, connect the transmitter to the target utility, then:

1. Press the  key to enter the menu.
2. Scroll to the OPT F menu using the  or  arrows.
3. Press the  key to select 'START'.
4. Press the  key to start the test. The transmitter will automatically select a general purpose frequency for use on the connected utility.

## Locating with Active Frequencies

Active frequencies are applied to the target pipe or cable using the transmitter, and provide the most effective way of tracing buried pipes or cables.

Generally speaking, it is better to use a low frequency on larger, low impedance utilities, and move to a higher frequency on smaller, high impedance utilities.

The lowest power setting required to trace the target utility should always be used to minimize the risk of false trails.

The transmitter can apply a signal using three different methods:

### Direct connection

In direct connection, you connect the transmitter directly to the pipe or cable you wish to survey using the red Direct Connect lead supplied. The black lead is generally connected to earth using the supplied ground stake.

The transmitter will then apply a discrete signal to the line, which you can trace using the locator. This method provides the best signal on an individual line and enables the use of lower frequencies, which can be traced for longer distances.

**⚠ WARNING! Direct connection to live conductors is POTENTIALLY LETHAL. Direct connections to live conductors should be attempted by fully qualified personnel only using the relevant products that allow connections to energized lines.**

### Induction

The transmitter is placed on the ground over or near the survey area. You select the appropriate frequency. The transmitter will then induce the signal indiscriminately to any nearby metallic conductor. In induction mode, using higher frequencies is generally recommended as they are induced more easily onto nearby conductors.

### Transmitter Clamp

An optional signal clamp can be placed around an insulated live wire or pipe up to 8.5" / 215mm in diameter to transfer the transmitter signal to the utility. This method of applying the transmitter signal is particularly useful on insulated live wires and removes the need to disconnect the supply to the cable.

**⚠ WARNING! Do not clamp around uninsulated live conductors.**

**⚠ WARNING! Before applying or removing the clamp around a power cable ensure that the clamp is connected to the transmitter at all times.**

## Locating with Passive Frequencies

Passive frequency detection takes advantage of signals that are already present on buried metallic conductors. The RD7100 supports up to three types of passive frequencies: Power, Radio and CPS\* signals. You can detect these frequencies without the aid of the transmitter.

\*Model specific.



## Power Filters

RD7100PL and PLG locators allows operators to take advantage of the harmonic signals found on power networks. Once in Power Mode, press the  key to switch out of Radiodetection's sensitive Power Mode and scroll through five individual Power Filters. This enables operators to establish if a single large power signal comes from one source or from the presence of multiple cables. The different harmonic characteristics of the detected lines can then be used to trace and mark their route.

Additionally the use of an individual harmonic can allow you to locate power lines in situations where the total signal would otherwise be too large.

## Locate Modes

Dependent on the model selected, the RD7100 offers a choice of up to 4 locate modes, each of which is designed for specific uses, depending on what task is being carried out.

To scroll between locate modes, press the  key.



**PEAK:** For accurate locating, the peak bargraph provides a visual readout of the signal strength. The peak signal is found directly over the buried utility.



**PEAK+:** Choose to combine the accuracy of the Peak bargraph with Null arrows, which can indicate the presence of distortion, or with proportional Guidance arrows for rapid line tracing – switch between them by holding the  key.



**GUIDANCE:** Proportional arrows and a ballistic 'needle' combine with audio left / right indication for rapidly tracing the general path of a buried utility.



**NULL:** Provides a quick left / right indication of the path of a utility. As Null is susceptible to interference, it is best used in areas where no other utilities are present.

## Depth, current and compass readouts

**⚠ WARNING! Never use the depth measurement readout as a guide for mechanical or other digging activity. Always follow safe digging guidelines.**

The RD7100 locator can measure and display the utility depth, locate signal current and the relative orientation of the cable or pipe to the locator. This helps you to make sure that you are following the right cable or pipe, especially when other utilities are present.

The RD7100 locator features TruDepth™, a feature that helps you to ensure the accuracy of your locates. The depth and current are automatically removed from the display when the locator is at an angle of more than 7.5° from the path of the cable or pipe being located, or when the locator determines that signal conditions are too poor for reliable measurements.

## Using accessories

The locator and transmitter are compatible with a wide range of accessories. For detailed information on using any of the accessories below please refer to the RD7100 locator operation manual.

### Transmitter signal clamps

When it is not possible to connect directly onto a pipe or cable, or induction mode is unsuitable, a transmitter signal clamp may be used. The clamp is plugged into the output of the transmitter and provides a means of applying a locate signal to an insulated live wire. This is particularly useful with live insulated cables as it removes the need to disable the power and break the line.

**⚠ WARNING! Do not clamp around uninsulated live conductors.**

**⚠ WARNING! Before applying or removing the clamp around a power cable ensure that the clamp is connected to the transmitter at all times.**

To locate or identify individual lines a locator signal clamp can be connected to the accessory socket of the locator and can be clamped around individual pipes or cables.

### Stethoscopes and locator signal clamps

Locator clamps can be used to identify a target cable or pipe amongst a number of different cables by checking for the strongest locate signal. When cables are bunched or tightly packed, a stethoscope antenna can be used in place of a clamp.

To use a stethoscope or locator signal clamp, connect it to the locator's accessory socket. The locator will automatically detect the device and filter out location modes that are irrelevant.

### Sondes, Flexrods and FlexiTrace

Sondes are battery powered transmitters that are useful for tracing non-metallic pipes. They can be fixed to Flexrods to allow them to be pushed through pipes or conduits, and some are suitable for blowing through ductwork. Some models of the RD7100 can detect a range of sonde frequencies, including those transmitted by GatorCam™4 or flexiprobe™ pushrod systems and P350 flexitrac™ crawlers.

For a detailed guide on locating sondes, please refer to the operation manual.

A FlexiTrace is a traceable fiberglass rod incorporating wire conductors with a sonde at the end. It is connected to the output of the transmitter and is typically used in small diameter, non-metallic pipes. The user has the option of locating the entire length of the cable or choosing to locate only the tip of the cable.

The FlexiTrace has a maximum power rating of 1W. When using the FlexiTrace with a Radiodetection Tx-5 or Tx-10 transmitter, the output limit must be set to 1W in the MAX P menu and the output voltage limit set to LOW in the MAX V menu.

No additional settings are required for the Tx-1 transmitter.

## Fault-finding with an A-Frame

The RD7100PL, PLG, TL and TLG models have the ability to detect cable or pipe insulation faults accurately using an A-Frame accessory. The Tx-5 and Tx-10 transmitters provide fault finding signals that can be detected by the A-Frame as a result of the signal bleeding to ground through damaged cable sheaths.

The Transmitter's multimeter function can be used to measure the impedance of the connected pipe or cable in order to characterize the fault.

For a detailed guide to fault-finding, please refer to the operation manual.

## Plug / Live cable connector

The plug connector is connected to the output of the transmitter and is used to put a signal onto a line and trace it from a domestic mains plug to the service cable in the street.

The live cable connector can be used to apply a signal to a live cable. Only suitably qualified personnel should use this equipment.

## Submersible antenna

This antenna is connected to the locator and used to locate pipes and cables underwater at depths of up to 300 feet / 100 meters.

**⚠ WARNING: use of the submersible antenna should be by fully licensed and experienced personnel only, and only after fully reading the operation manual!**

## RD Manager PC Software

RD Manager is the RD7100 locator system PC companion, and it allows you to manage and customize your locator. RD Manager is also used to retrieve and analyze survey and usage data, run an eCert calibration, and to perform software upgrades.

You can use RD Manager to register your products to obtain an extended warranty, setup your locator by performing a number of maintenance tasks such as adjusting date and time, activating and de-activating active frequencies, or by setting-up functions like CALSafe or StrikeAlert.

RD Manager is compatible with PCs running Microsoft Windows XP, 7, 8 and 8.1. To download RD Manager, go to [www.radiodetection.com/RDManager](http://www.radiodetection.com/RDManager).

If you do not have internet access, or wish to receive RD manager on a CD-ROM, contact your local Radiodetection office or representative.

For more information about RD Manager refer to the RD Manager operation manual.

## Automatic Usage-Logging

RD7100 locator models equipped with GPS offer a powerful data logging system which records all the instrument's critical parameters (including GPS position, if available) and warnings in its internal memory every second.

The automatic logging system is always active and cannot be disabled. The locator's memory is capable of storing over 500 days of usage data, when used for 8 hours per day.

Logs can be retrieved using the RD Manager PC application for usage analysis and survey validation. Refer to the RD Manager operation manual for further information.

## GPS

The RD7100 locator can use an internal GPS module (GPS models only) to be able to detect and store its latitude, longitude and accurate UTC time alongside its location data. This positional information is then appended to the automatic usage-logging system.

The presence of GPS data allows for the data to be mapped easily and to export and save the information directly into GIS systems.

## GPS menu settings

There are 5 options in the GPS menu:

- INT: Select this to use the internal GPS if present.
- OFF: Select this to switch off the internal GPS module and save battery.
- SBAS: Set SBAS (Satellite-based augmentation systems) mode to improve GPS accuracy. When ON the GPS system will take longer to lock.
- RESET: Select YES to reset the internal GPS (GPS models only).

## CALSafe

GPS equipped RD7100 locators models are equipped with a system which can be enabled to force them to shut down once they are beyond the expected service / calibration date.

When the unit is within 30 days of the service due date the unit will display at startup the number of days left. The locator will stop functioning on the service due date.

CALSafe is disabled by default. You can enable the CALSafe feature and edit the CALSafe service / calibration due date using the RD Manager PC software. Refer to the RD Manager operation manual for further information.

## Training

Radiodetection provides training services for most Radiodetection products. Our qualified instructors will train equipment operators or other personnel at your preferred location or at Radiodetection headquarters. For more information go to [www.radiodetection.com](http://www.radiodetection.com) or contact your local Radiodetection representative.

## Care and maintenance

The RD7100 locator and transmitter are robust, durable and weatherproof. However you can extend your equipment's life by following these care and maintenance guidelines.

### General

Store the equipment in a clean and dry environment.

Ensure all terminals and connection sockets are clean, free of debris and corrosion and are undamaged.

Do not use this equipment when damaged or faulty.

### Batteries and power supply

Only use the rechargeable battery packs, chargers and power supplies approved by Radiodetection.

If not using rechargeable packs, use good quality Alkaline or NiMH batteries only. Batteries should be disposed of in accordance with your company's work practice, and / or any relevant laws or guidelines in your country.

### Cleaning

**⚠ WARNING! Do not attempt to clean this equipment when it is powered or connected to any power source, including batteries, adapters and live cables.**

Ensure the equipment is clean and dry whenever possible.

Clean with a soft, moistened cloth. Do not use abrasive materials or chemicals as they may damage the casing, including the reflective labels. Do not use high pressure jets of water to clean the equipment.

If using this equipment in foul water systems or other areas where biological hazards may be present, use an appropriate disinfectant.

## Software upgrades

From time to time, Radiodetection may release software upgrades to enhance features and improve performance of the RD7100 locator or transmitter. Software upgrades are free of charge and provided through the RD Manager PC software

E-mail alerts and notification of new software releases are sent to all registered users. You can also check if your products are up-to-date or upgrade them by using the RD Manager software upgrade screen.

**NOTE: To upgrade your product's software you need to have created an account using RD Manager and have a live internet connection. An optional Radiodetection power supply may be required to update your transmitter software.**

### Disassembly

Do not attempt to disassemble this equipment under any circumstances. The locator and transmitter contain no user serviceable parts.

Unauthorized disassembly will void the manufacturer's warranty, and may damage the equipment or reduce its performance.

### Service and maintenance

Regularly check your equipment for correct operation by using the Self-Test function and eCert.

The locator and transmitter are designed so that they do not require regular recalibration. However, as with all safety equipment, it is recommended that they are serviced and calibrated at least once a year either at Radiodetection or an approved repair center.

**NOTE: Service by non-approved service centers may void the manufacturer's warranty.**

Details of Radiodetection offices and distribution partners can be found at [www.radiodetection.com](http://www.radiodetection.com).

Radiodetection products, including this guide, are under continuous development and are subject to change without notice. Go to [www.radiodetection.com](http://www.radiodetection.com) or contact your local Radiodetection representative for the latest information regarding the RD7100 locator or any Radiodetection product.

# Global locations

## USA

**SPX Global Headquarters** 13320 Ballantyne Corporate Place, Charlotte, NC 28277, USA  
Tel: +1 704 752 4400 [www.spx.com](http://www.spx.com)

**Radiodetection** 28 Tower Road, Raymond, Maine 04071, USA  
Tel: +1 (207) 655 8525 Toll Free: +1 (877) 247 3797 Fax: +1 (207) 655 8535  
[rd.sales.us@spx.com](mailto:rd.sales.us@spx.com) [www.radiodetection.com](http://www.radiodetection.com)

**Pearpoint** 39-740 Garand Lane, Unit B, Palm Desert, CA 92211, USA  
Tel: +1 800 688 8094 Tel: +1 760 343 7350 Fax: +1 760 343 7351  
[pearpoint.sales.us@spx.com](mailto:pearpoint.sales.us@spx.com) [www.radiodetection.com](http://www.radiodetection.com)

**Radiodetection (Canada)** 344 Edgeley Boulevard, Unit 34, Concord, Ontario L4K 4B7, Canada  
Tel: +1 (905) 660 9995 Toll Free: +1 (800) 665 7953 Fax: +1 (905) 660 9579  
[rd.sales.ca@spx.com](mailto:rd.sales.ca@spx.com) [www.radiodetection.com](http://www.radiodetection.com)

## EUROPE

**Radiodetection Ltd. (UK)** Western Drive, Bristol BS14 0AF, UK  
Tel: +44 (0) 117 976 7776 Fax: +44 (0) 117 976 7775  
[rd.sales.uk@spx.com](mailto:rd.sales.uk@spx.com) [www.radiodetection.com](http://www.radiodetection.com)

**Radiodetection (France)** 13 Grande Rue, 76220, Neuf Marché, France  
Tel: +33 (0) 2 32 89 93 60 Fax: +33 (0) 2 35 90 95 58 [rd.sales.fr@spx.com](mailto:rd.sales.fr@spx.com)  
<http://fr.radiodetection.com>

**Radiodetection (Benelux)** Industriestraat 11, 7041 GD 's-Heerenberg, Netherlands  
Tel: +31 (0) 314 66 47 00 Fax: +31 (0) 314 66 41 30  
[rd.sales.nl@spx.com](mailto:rd.sales.nl@spx.com) <http://nl.radiodetection.com>

**Radiodetection (Germany)**  
Groendahlscher Weg 118, 46446 Emmerich am Rhein, Germany  
Tel: +49 (0) 28 51 92 37 20 Fax: +49 (0) 28 51 92 37 520  
[rd.sales.de@spx.com](mailto:rd.sales.de@spx.com) <http://de.radiodetection.com>

## ASIA-PACIFIC

**Radiodetection (Asia-Pacific)** Room 708, CC Wu Building, 302-308 Hennessy Road, Wan Chai  
Hong Kong SAR, China  
Tel: +852 2110 8160 Fax: +852 2110 9681 [rd.sales.asiapacific@spx.com](mailto:rd.sales.asiapacific@spx.com) [www.radiodetection.com](http://www.radiodetection.com)

**Radiodetection (China)** Room 5-10, Workshop 4, No. 10 Zhenggezhuang Village Beiqijia Town,  
Changping District, Beijing 102209, China  
Tel: +86 (0) 10 8178 5652 Fax: +86 (0) 10 81785662  
[rd.service.cn@spx.com](mailto:rd.service.cn@spx.com) <http://cn.radiodetection.com>

**Radiodetection (Australia)** Unit H1, 101 Rookwood Road, Yagoona NSW 2199, Australia  
Tel: +61 (0) 2 9707 3222 Fax: +61 (0) 2 9707 3788  
[rd.sales.au@spx.com](mailto:rd.sales.au@spx.com) [www.radiodetection.com](http://www.radiodetection.com)

© 2015 Radiodetection Ltd. All rights reserved. Radiodetection is a subsidiary of SPX Corporation. SPX, the green ">" and "X" are trademarks of SPX Corporation, Inc. Radiodetection and RD7100 are either trademarks of Radiodetection in the United States and/or other countries. Due to a policy of continued development, we reserve the right to alter or amend any published specification without notice. This document may not be copied, reproduced, transmitted, modified or used, in whole or in part, without the prior written consent of Radiodetection Ltd.