

RADIODETECTION 

RD1100™

Ground Penetrating Radar
for Locating Buried Utilities

Operation Manual

90/RD1100-OPMAN-ENG/01

Table of Contents

Section 1 - Preface.....	1
1.1 Important notices	1
1.2 Intellectual property	2
Section 2 - Introduction	3
2.1 About this manual.....	3
2.2 About the RD1100	3
2.3 Manual outline	3
2.4 Safety.....	4
2.5 Training.....	4
Section 3 - System Overview	5
3.1 Introduction.....	5
Section 4 - Assembly	6
4.1 Out of the box.....	6
4.2 Fully Assembled	9
Section 5 - Getting Started.....	10
5.1 Powering up.....	10
5.2 Shutting down.....	11
5.3 Interacting with the Display Unit	12
5.4 Swipe Down menu.....	13
Section 6 - Tools & Setup	15
6.1 Preferences	15
Language	16
Units	16
Volume	16
Brightness	16
Screen saver	16
Auto-Hide Buttons	16
Anonymous Usage Statistics	16
6.2 System Settings.....	16
Date/Time	17
WiFi Settings	17
Locale	20
GPS	21
Reset to Defaults	21
6.3 System Test.....	21
System Information	22
Keypad Test	23
Audio	23
Touch Screen	24
Sensor Test	24
Odometer Calibration	25
GPS	26
Section 7 - GPR Concepts.....	28

Preface

7.1 Theory.....	28
7.2 Hyperbolas	28
7.3 Calculating Depth	29
7.4 Soil Calibration values	29
7.5 Air Waves	30
Section 8 - Data Collection.....	31
8.1 Acquiring Data	31
8.2 Back-up Indicator.....	32
8.3 Flags.....	34
8.4 Line Scan menu options.....	34
Clear	34
Zoom	34
Color	37
Filter	37
Gain	38
Soil Cal	39
Pause button	41
Drawing arrows	41
Saving images as screenshots	42
Section 9 - Screenshots & Mini-reports	43
9.1 Capturing Screens.....	43
9.2 Screenshot Gallery	44
9.3 Using the Hotspot on your SmartPhone.....	46
9.4 Mini-Reports	46
Section 10 - Transferring Data to a PC.....	48
Section 11 - Troubleshooting	50
11.1 Power Supply	50
11.2 System Communications.....	50
11.3 System Overheating.....	51
11.4 Display Unit Problem.....	51
11.5 Wobbly Wheels.....	51
11.6 Creating a Test Line for Data Quality	51
11.7 Contacting the Vendor for Service	51
Section 12 - Care and Maintenance	53
12.1 Battery Care	53
12.2 Cable Care	53
12.3 Skid Pads	54
12.4 Odometer.....	54
12.5 Storage Cases.....	54
12.6 Upgrading Embedded Software on Display Unit.....	54
Section 13 - Technical Specifications	56
Section 14 - Warranty	57

14.1 Statement of warranty conditions 57

Section 15 - Appendix A: Health & Safety Certification 59

Section 16 - Appendix B: GPR Emissions, Interference and Regulations..... 61

Section 17 - Appendix C: Instrument Interference 69

Section 18 - Appendix D: Safety around Explosive Devices 70

Section 19 - Appendix E: WiFi Module 71

Section 20 - Appendix F – Import/Export..... 71

Section 1 - Preface

Before you begin

Thank you for your interest in Radiodetection's RD1100 Ground Penetrating Radar system.

Please read this user manual in its entirety before attempting to use the RD1100.

Radiodetection products, including this manual, are under continuous development. The information contained within is accurate at time of publication; however the RD1100, this manual and all its contents are subject to change.

Radiodetection reserves the right to modify the product without notice and some product changes may have taken place after this user manual was published.

Contact your local Radiodetection dealer or visit www.radiodetection.com for the latest information about the RD1100, including this manual, and the rest of the Radiodetection range of products designed for locating buried utilities.

1.1 Important notices

General

This instrument, or family of instruments, will not be permanently damaged by reasonable electrostatic discharge and has been tested in accordance with IEC 801-2. However, in extreme cases temporary malfunction may occur. If this happens, switch off, wait and switch on again. If the instrument still malfunctions, disconnect the power supply for a few seconds before restarting.

Safety

 **WARNING!** Failure to comply with safety warnings can cause serious injury or death

CAUTION!: Failure to comply with safety cautions can result in damage to equipment or property

This equipment shall be used only by qualified and trained personnel, and only after fully reading this Operation Manual.

Use the Display Unit only as specified in these operating instructions or the protection provided by the unit may be impaired.

The battery charger/AC adapter must only be connected to a power outlet which provides a protective earth (ground).

Connect the AC power cord only to designated power sources as marked on the battery charger/AC adapter.

The battery charger/AC adapter is rated for indoors use only.

Do not replace detachable MAINS supply leads for the battery charger/AC adapter with inadequately rated leads.

Do not position the Display Unit such that it is difficult to disconnect the 37-pin GPR connector.

The exterior of this product should be cleaned using a damp cloth.

1.2 Intellectual property

© 2016 Radiodetection Ltd. All rights reserved. Radiodetection is a subsidiary of SPX Corporation. Radiodetection and RD1100 are registered trademarks of Radiodetection in the United States and/or other countries.

Section 2 - Introduction

2.1 About this manual

This manual provides utility locating and other professionals with comprehensive operating instructions for the RD1100™ system. Before operating the RD1100 system it is very important that you read this manual, noting all safety warnings and procedures.

2.2 About the RD1100

The Radiodetection RD1100 is a state of the art Ground Penetrating Radar system.

Designed specifically for utility locating, RD1100 is an advanced Ground Penetrating Radar for the detection of non-conductive pipes and ducts. Using a grid based data collection system, it is possible to build up both horizontal and vertical depth maps. A high resolution screen, on-site analysis tools, and advanced reporting capabilities with Wi-Fi data transfer, allow locate professionals and surveyors to both mark artefacts and to generate and deliver customer field reports while on-site.

2.3 Manual outline

Section 1 includes an overview of safety procedures and notices. Review them before moving on to Section 2 and the rest of this manual

Section 3 provides an overview of the RD1100 system

Section 4 shows how to assemble the RD1100 system

Section 5 describes Getting Started

Section 6 covers the Tools and Setup

Section 7 provides an overview of GPR Concepts

Section 8 covers Data Collection

Section 9 shows Capturing Screenshots and Emailing Mini Reports

Section 10 introduces Transferring Data to a PC

Section 11 is the Troubleshooting section

Section 12 covers Care and Maintenance

Section 13 has the Technical Specifications of the RD1100

Section 14 explains the Warranty

Sections 15 to 20 are the Appendices covering:

Appendix A: Health & Safety Certification

Appendix B: GPR Emissions, Interference and Regulations

Introduction

- Appendix C: Instrument Interference
- Appendix D: Safety around Explosive Devices
- Appendix E: Wi-Fi Module
- Appendix F: Import/Export

2.4 Safety

Read this manual in its entirety before attempting to operate the RD1100. Note all safety notices in the preface and throughout this manual

Follow your company and national safety procedures and or requirements when operating this equipment in any environment or workplace. If you are unsure what policies or procedures apply, contact your company or site's occupational health and safety officer or your local government for more information.

Do not use this equipment if you suspect that any component or accessory is damaged or faulty.

Use authorized accessories only. Incompatible accessories may damage the equipment or give inaccurate readings.

Keep this equipment clean and arrange for regular services with an authorized Radiodetection service center. More information can be found in the Appendix or from your local Radiodetection representative.

Do not attempt to open or dismantle any part of this equipment unless directed specifically by this manual. Doing so may render the equipment faulty and may void the manufacturer's warranty.

2.5 Training

Radiodetection provides training services for most Radiodetection products. Our qualified instructors will train equipment operators or other personnel at your preferred location or at Radiodetection headquarters.

For more information go to www.radiodetection.com or contact your local Radiodetection representative.

Section 3 - System Overview

3.1 Introduction

Congratulations on purchasing the RD1100 Ground Penetrating Radar (GPR) system. This system is optimized for locating buried utilities. With a very simple menu and user-friendly interface, you will be finding targets in minutes.

Features of the RD1100 include:

- High visibility, touch screen display
- UWB (ultra-wide band) Antenna producing highest data quality
- Lightweight fibreglass cart frame
- Built-in WiFi capability
- Integrated GPS receiver for geo-referencing data
- Ability to draw arrows on the screen, to highlight objects
- Easy screen captures of data

This manual describes everything you need to assemble the system, change settings and start scanning. There is also a section that describes the basics of GPR theory and techniques for locating utilities.

This manual references embedded software version V1. To see which software version is installed on your system, see the Swipe Down menu in Section 5.4.

Section 4 - Assembly

4.1 Out of the box

You will find the following components in your RD1100 box. Some of these may already be assembled.



Attach the Cart Handle to Cart Base using the Handle Pins. Ensure the Display Unit Tray is facing the operator.



Attach the GPR Sensor to the Cart using the Sensor Support Straps. Ensure the Sensor is oriented the correct way with the connections toward the back of the Cart. Using the Sensor Support Straps, adjust the height of the Sensor so it is 1-2 cm ($\frac{1}{2}$ – $\frac{3}{4}$ inch) above the ground. The best way to get a uniform Sensor height is to place a couple of sheets of thick cardboard, particle board or Styrofoam on a level surface under the sensor before securing the Sensor Support Straps.



Attach the Display Unit onto the Display Unit Tray on the Cart. The Display unit slides down into the tray, catching on both sides of the mount and is held in place with the pull pin. When a click is heard, the Display Unit is firmly in place. Adjust the angle of the Display Unit by loosening the hand-screws underneath the Display Unit Tray, rotating the Display Unit to the desired angle and tightening the hand-screws. To remove the Display Unit, disconnect all cables, pull out the pull pin and lift the Display Unit up.



Assembly

Attach the Display Cable to the back of the Display Unit with the jackscrews then connect the other end of the cable to the Sensor. Ensure the cable is routed as shown below.



Attach the Odometer and Battery Cables. The Odometer Cable connects to the closest receptacle on the Sensor. Attach the Battery Cable to the Sensor and the Battery. The system is now set up and ready to use.

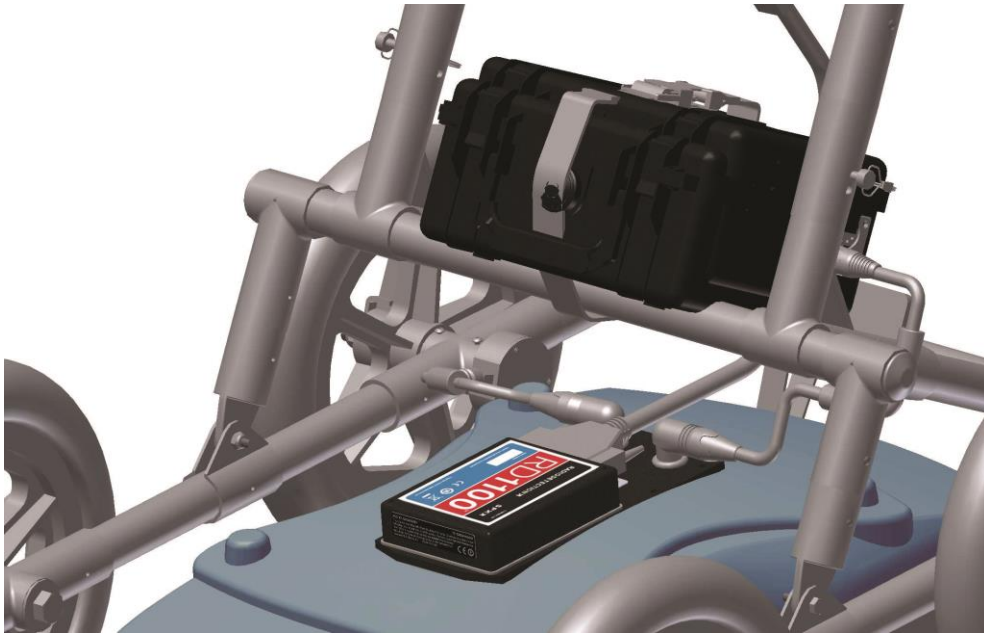

4.2 Fully Assembled

The fully assembled RD1100 will look like the following. Simply reverse the directions above to disassemble for transport.



Section 5 - Getting Started

5.1 Powering up

1. When the battery is first plugged in, the LED goes green for 5 seconds then disappears.
2. To start the system, press the red power button on the display unit. The LED on the front panel will light up red.

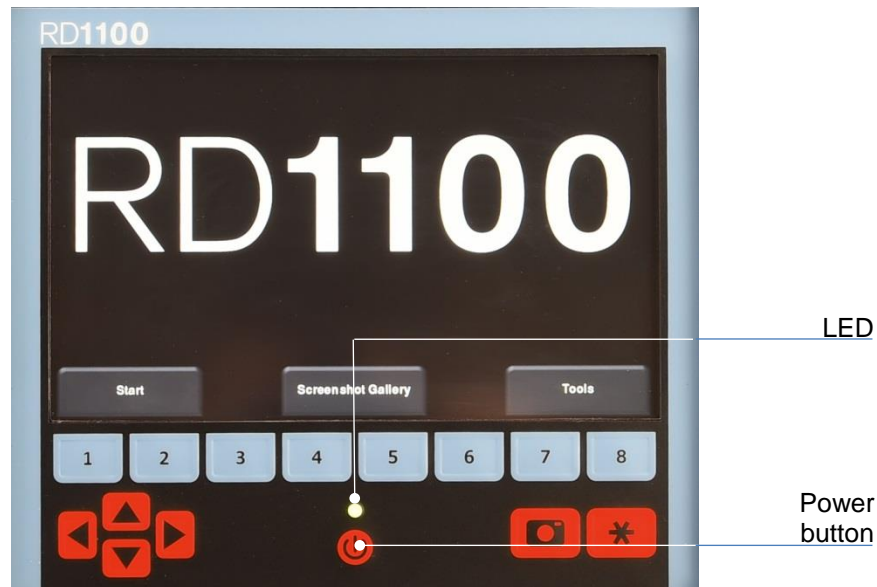

Figure 5-1: Front of Display Unit

Once boot up is complete, the color of the LED will indicate the amount of battery power remaining:

- green = 100% to 20%
- orange = 20% to 10%
- red = 10% to 0%

The first time you turn on the RD1100, you will need to configure the system. A series of screen prompts will allow you to setup the language, units, date & time, and some other options. You will have to do this again anytime you update the embedded software (See **Section 12.6**).

Every subsequent time the system boots up, you will see the main screen (Figure 5-2).

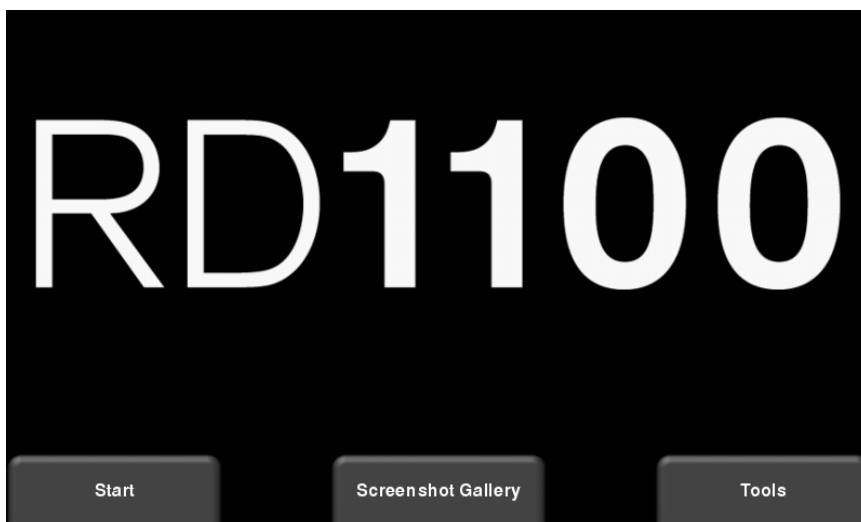

Figure 5-2: Main Screen for RD1100

5.2 Shutting down





To power down, press the red power button on the display unit once. A confirmation message will appear, after which you can press **Yes** to proceed. If necessary, a hard shutdown can be done by pressing and holding the red power button until the unit shuts down.

5.3 Interacting with the Display Unit

Data collection is controlled by the Display Unit. The Display Unit has embedded software to set survey parameters and collect, display and store data.

The Display Unit offers touch screen operation, as well as a water-resistant membrane keypad with a number of buttons that can be pressed to perform various tasks. Most operations can be done using either the touch screen or the keypad.

Use the following table as a guide to working with the keypad on the Display Unit:

Item	Description
<p>Menu Buttons</p> 	<p>The blue buttons labelled 1 to 8 correspond to menu choices that appear on the screen.</p>
<p>4-way directional keypad</p> 	<p>Controls Up/Down/Left/Right operations in certain menus.</p>
<p>Camera</p> 	<p>Saves a screenshot of line data, grid data or the Map View display.</p>
<p>Asterisk / Special Function</p> 	<p>Used for adding Flags during data acquisition, and to quickly enter the No Save mode for Line Scan data collection.</p>

5.4 Swipe Down menu

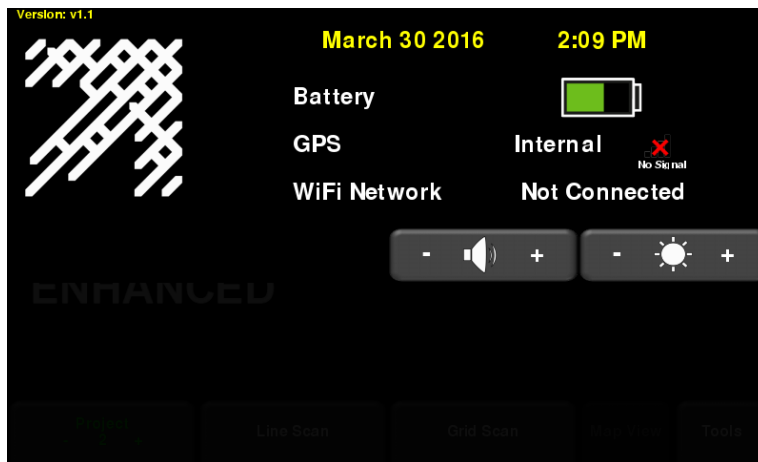

Figure 5-4: Swipe-Down menu

When the Display Unit is powered on (except during data acquisition), you can “swipe” your finger from the top of the screen towards the bottom, to bring up a drop-down menu (Figure 5-4) with the following items:

Date and Time: The current date and time (12 hour clock).

NOTE: The time needs to be changed in areas that observe daylight-savings-time.

Battery: The battery icon displays the amount of power remaining in the battery. If the battery power is getting low, the icon will change color to orange and red to match the LED color on the keypad.

GPS: Shows the status of the GPS receiver and the signal strength.

WiFi Network: Indicates if the system is connected to a wireless network and, if so, the name of the network. See **WiFi Settings** in **Section 6.2** for details on connecting the system to a wireless network.

Volume: The **Volume +** and - buttons are used to increase and decrease speaker volume.

Brightness: The **Brightness +** and - buttons are used to increase and decrease the screen brightness. For example, increasing the Brightness setting may improve the visibility of the screen in bright sunlight.

Getting Started

NOTE: Increasing the screen brightness also increases power consumption, thus reducing battery life.

To close the Swipe-Down menu, touch anywhere on the screen below the swipe-down menu.

Section 6 - Tools & Setup

From the main screen, press **Tools** to enter this sub-menu. Here you can set preferences, adjust system settings, perform system tests and manage files. You will see the screen shown in Figure 6-1:

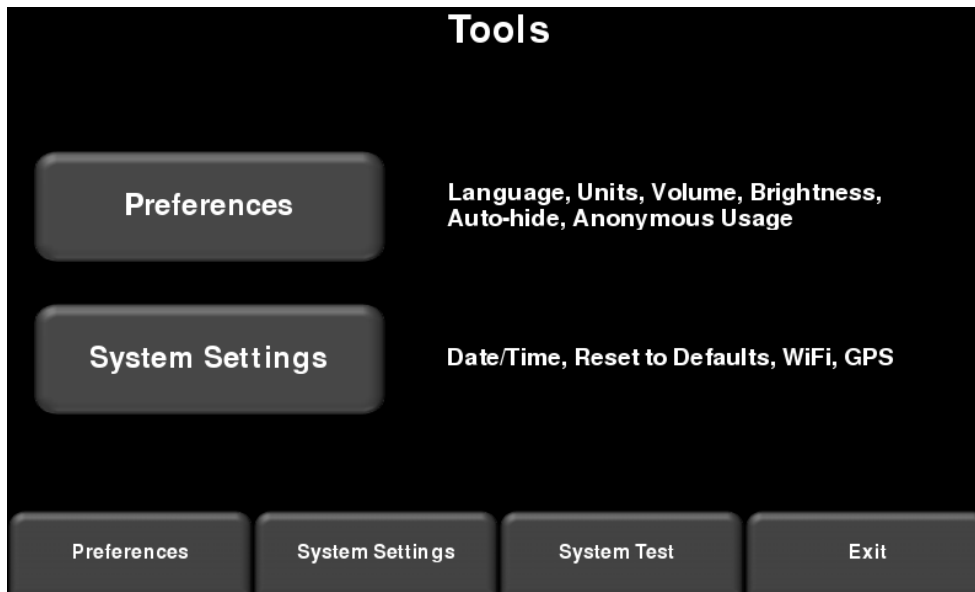

Figure 6-1: Tools menu

6.1 Preferences

Selecting the preferences option will take you to the sub-menu shown in Figure 6-2.

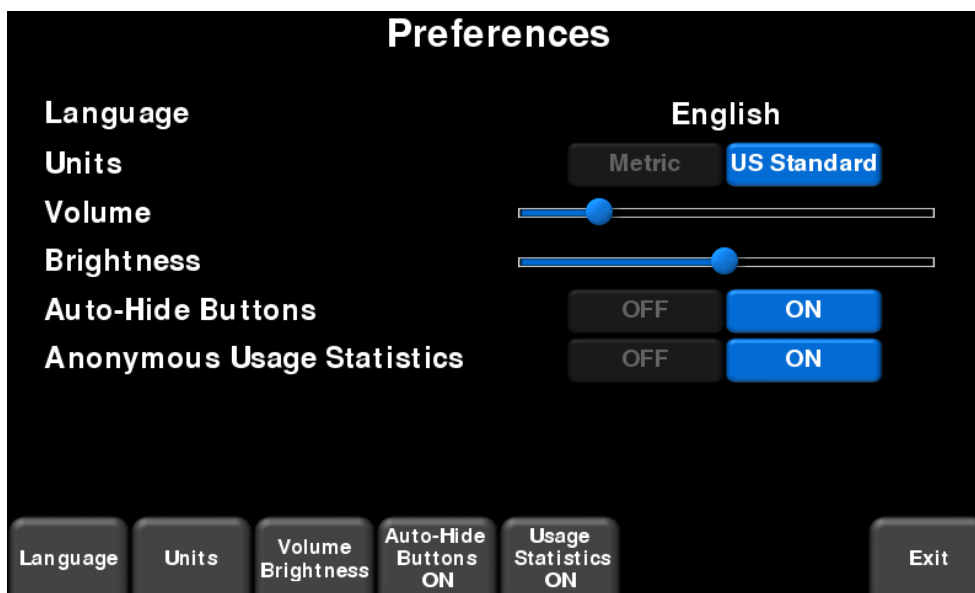

Figure 6-2: Setting Preferences

From here you can select the following:

Language

Pressing **Language** will cycle between available languages.

Units

Pressing **Units** will cycle between US Standard and Metric Units.

Volume

Scroll bar for adjusting the volume of clicks and beeps heard during operation. This can also be changed by using the Swipe Down menu (Section 5.4) anytime the system is not collecting data.

Brightness

Scroll bar for adjusting the brightness of the screen. This can also be changed by using the Swipe Down menu (Section 3.4) anytime the system is not collecting data.

NOTE: Increasing the screen brightness also increases power consumption, thus reducing battery life.

Screen saver

Pressing the Volume/Brightness button at the bottom of the screen will change the bottom menu options, allowing you to change the volume and brightness as well as turn the Screen Saver on and off. You can set the time interval to either 1 minute or 5 minutes before the screen turns off. Once the screen turns off, simply touch anywhere on the screen to turn it back on again.

Auto-Hide Buttons

If this is set to ON, then in Line Scan mode, the buttons at the bottom of the screen disappear shortly after data collection begins, effectively enlarging the area for data display. The buttons will re-appear after a couple of seconds whenever the sensor stops moving forward, is in back-up mode or any button is pressed on the keypad.

Anonymous Usage Statistics

When this is set to ON and the user is connected to a wireless network, any system malfunctions will trigger an automatic notification to the manufacturer. This is to help with gathering information about any system irregularities. As the name suggests, the notification is completely anonymous and no personal information is sent.

6.2 System Settings

Press **System Settings** to enter the menu shown in Figure 6-3.

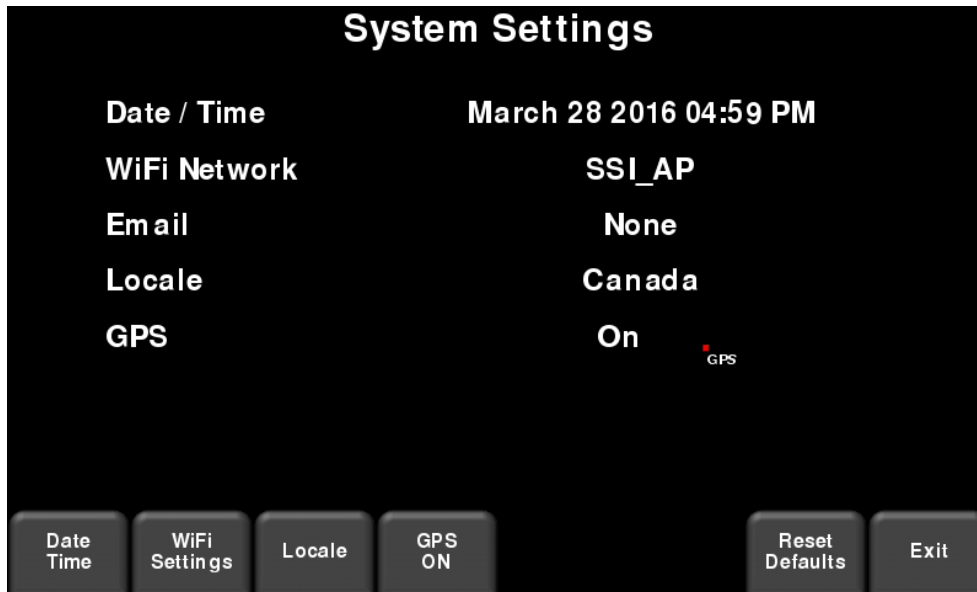

Figure 6-3: System Settings

From here, the following settings can be changed:

Date/Time

Set the date and time by pressing this button.

WiFi Settings

Connecting to a wireless network allows you to send a mini-report to someone by email. In order to send reports to an email address there are 2 main steps required.

First, the user must establish a Gmail™ account online. This account is used as the account that sends the message to the desired recipient. All mini-reports received by the recipient will look like they are coming from this account. This account will contain all the *SENT* messages in its sent box.

The second step is to connect to a wireless network. This connection gives you access to the internet to connect to your Gmail account. This connection can be through a standard wireless network or through a hotspot on your cell phone for connecting while in the field. Once you have done this, you can input your Gmail account and password on the Display Unit.

If you are already connected to a WiFi network, the name of the network is listed beside the WiFi Network field. Pressing the **WiFi Settings** button at the bottom of the screen takes you to a sub-menu (Figure 6-4) for connecting and configuring WiFi settings, as well as setting up an email address.

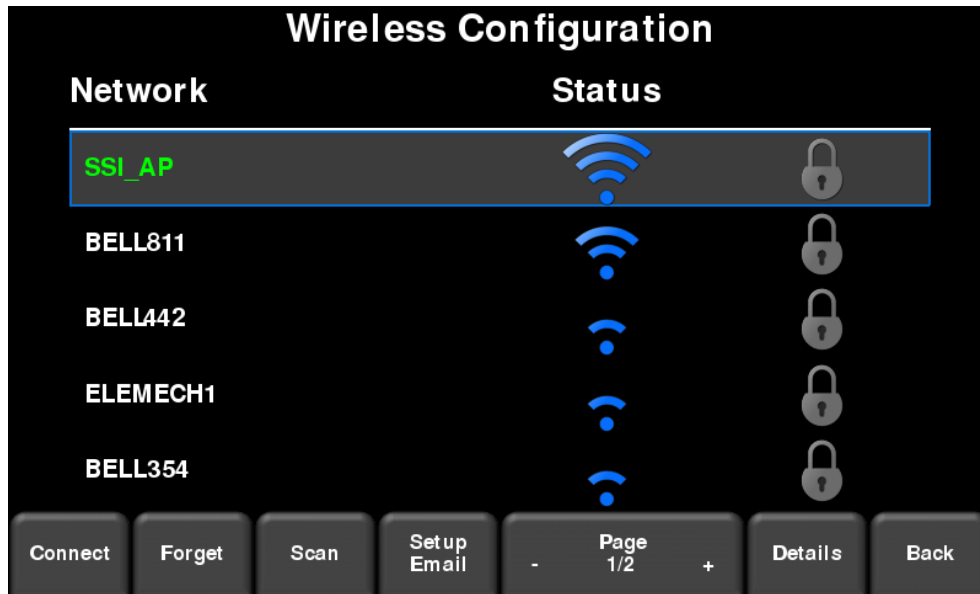

Figure 6-4: Configuring Wireless settings and Email address

Use the 4-way directional arrows or touch screen to select the network. The color of the Network Name indicates the status:

- Green = Connected
- Yellow = Not currently connected, but remembered from before when you previously connected and entered a password.
- White = Not connected

NOTE: RD1100 **CANNOT** connect to Public Hotspots, such as those in restaurants, hotels and airports, that require a web-based login and acceptance of Terms & Conditions. It also **CANNOT** connect to unsecured networks (networks that do not require a password).

- **Connect** – Connects to the desired network.
If the connection is successful (this can take a minute or so) a screen appears asking for the password for that network. If the network name is yellow (from a previous connection to this network), it will not ask for a password because it is a remembered network. Once it connects the Network Name will turn green.
- **Forget** – Removes the password for connected or remembered networks (text in green or yellow). Use the 4-way directional arrows or touch screen to select the network. Once the 'forget' button is pressed on a selected network it will remove the password and the Network Name will turn white.
- **Scan** – Scans for any available networks in the area and displays them in order of strength of signal.

- **Details** – Displays the security settings related to the selected network.
- **Setup Email** – Saves your Gmail account (email and password) to the RD1100, thereby enabling you to email mini reports from the job site. Before selecting this option:
 1. You must be connected to WiFi – a wireless network listed must be green.
 2. The Gmail account needs to be set up prior to adding it into the system (go to <https://accounts.google.com/SignUp>).

After entering the email address, a message appears stating either that the email address has been saved, or that the setup has failed.

If the address has been saved, you are ready to send mini reports.

If setup failed, there are 3 possible reasons:

1. Email address or password was entered incorrectly – try re-entering these fields.
2. The Display Unit is not connected to the internet – try reconnecting to a known network. Note that any networks requiring a web-based login will not work on the Display Unit.
3. Your email security settings **may need** to be adjusted, as shown below.

NOTE: The following screen images are current as of writing this manual. However, these may change over time as Google updates their menu layout.

To edit the security settings, visit <https://myaccount.google.com/> and sign into your account. You will then see the screen below. Click on “Connected apps & sites”

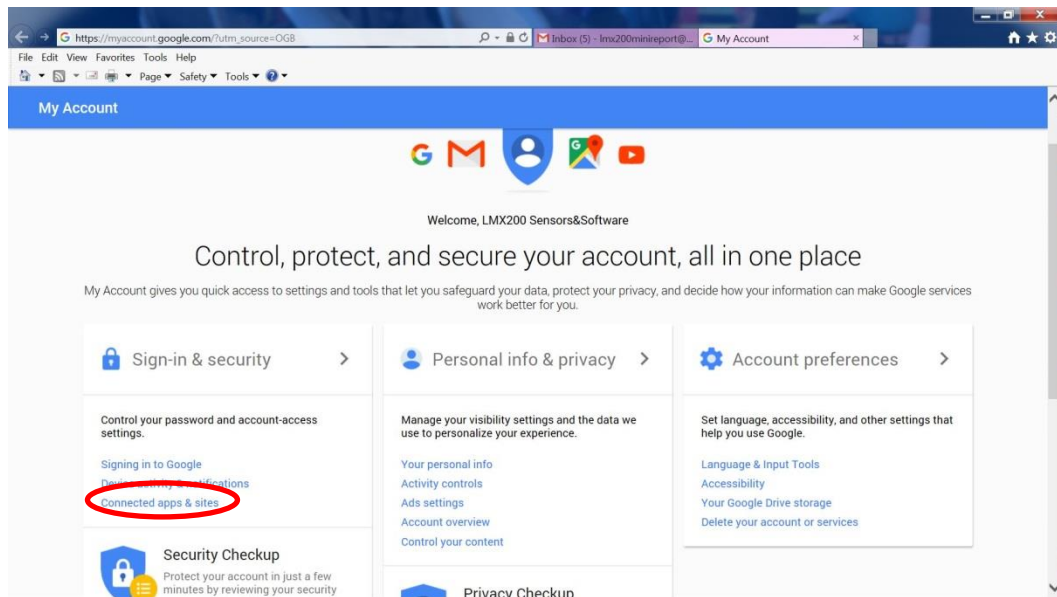

On the page that follows, ensure the setting “Allow less secure apps” is set to ON:

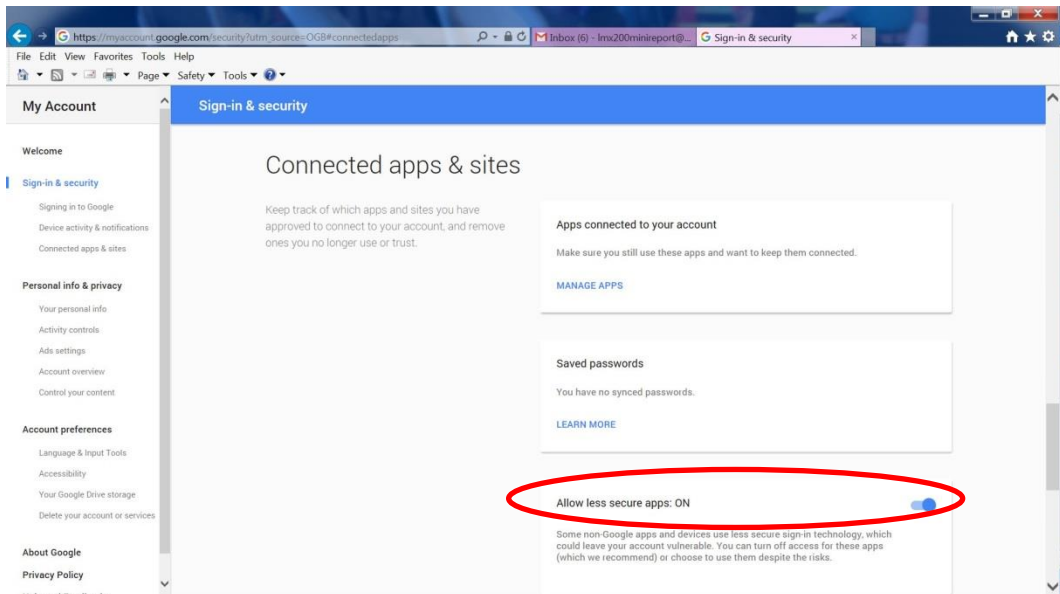

Locale

Pressing Locale allows you to set the country or region that you are operating in. Use the + and – buttons to move alphabetically to the next or previous country or region. Press Apply to accept the change and return, see Figure 6-5.

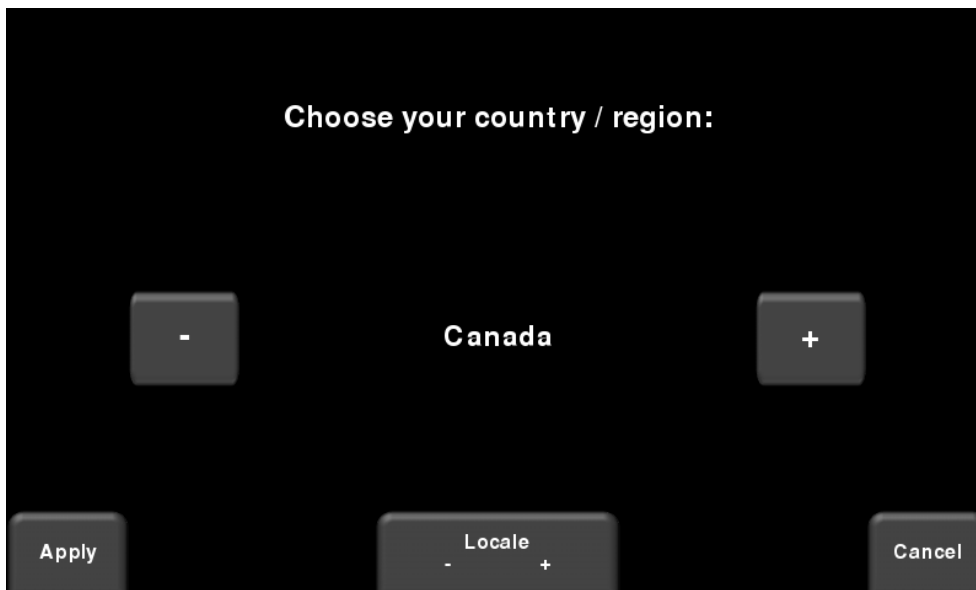

Figure 6-5: Setting the Locale

GPS

Pressing GPS will toggle between turning the internal GPS on or off; this will be shown on the button and on the screen beside the GPS field. Located beside that, the GPS strength indicator shows how many satellites the GPS is picking up. The meaning of the colour and bars is shown in the table below:

Indicator Color	# of bars	# of Satellites
Red	1	4
Orange	2	5
Green	3	6,7
Green	4	8,9
Green	5	10+

Reset to Defaults

This will reset all settings and preferences back to the initial settings when the system was shipped. Pressing this will ask you to confirm the Reset to Defaults. If **Yes** is selected, the next screen will ask if you would like to remove all saved wireless networks and email addresses.

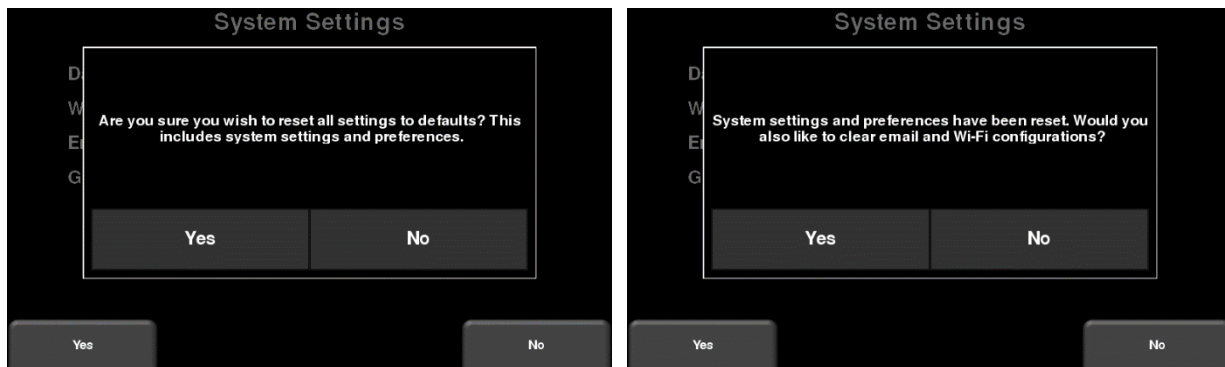

Figure 6-6: Reset to Defaults, a) Image on left is the first confirmation screen. b) If you press **Yes**, you will see the second confirmation screen, on the right, asking about deleting emails and WiFi settings.

6.3 System Test

The System Test sub-menu (Figure 6-7) allows the user to perform certain tests to ensure proper operation of the system. Select the component to test then press **Start**. After completing a test there is an indication of whether the system passed or failed the test. Each test is described below in more detail.

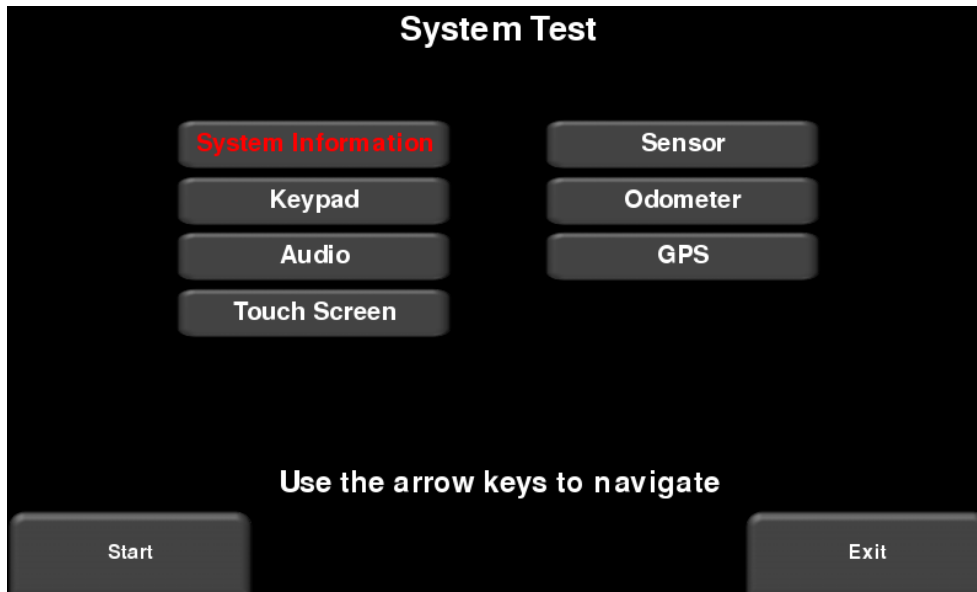

Figure 6-7: System Test menu

System Information

System Information is the only option in System Test which is not actually a test. Here information such as the version, serial numbers, temperature and battery power is displayed. (Figure 6-10).). If a USB key is currently inserted, pressing Export will export a file containing this information.

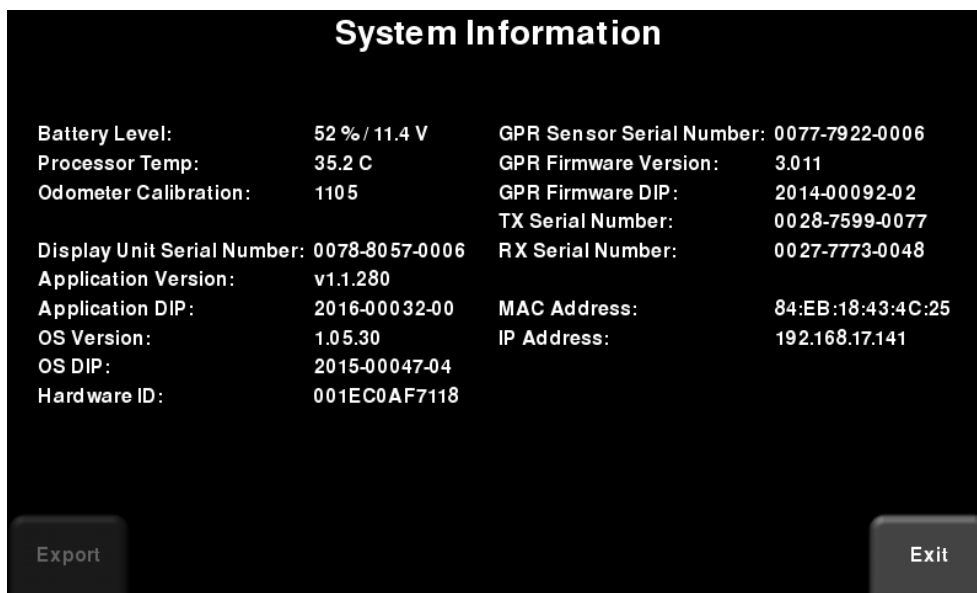

Figure 6-8: System Information

Keypad Test

The keypad test ensures that all buttons on the membrane keypad are working. Press **Start** to begin the test which requires the user to press each button once, within a 20 second timeframe (Figure 6-9).

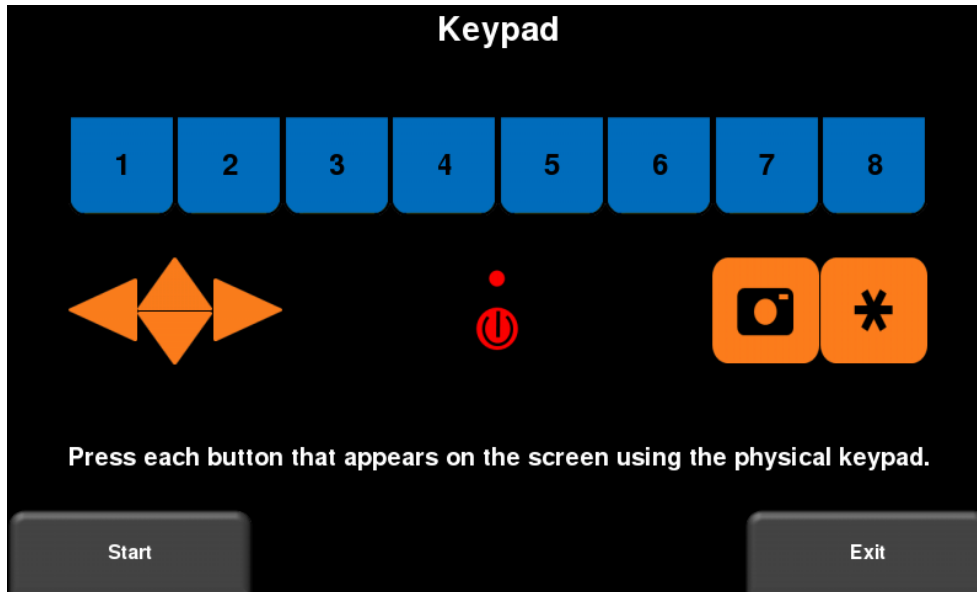

Figure 6-9: Keypad Test

Once that is complete, a short LED test will ensue, which checks the proper operation of the LED.

Audio

This test ensures that the speaking is operating properly. After starting the test, you should hear a sound with an increasing pitch.

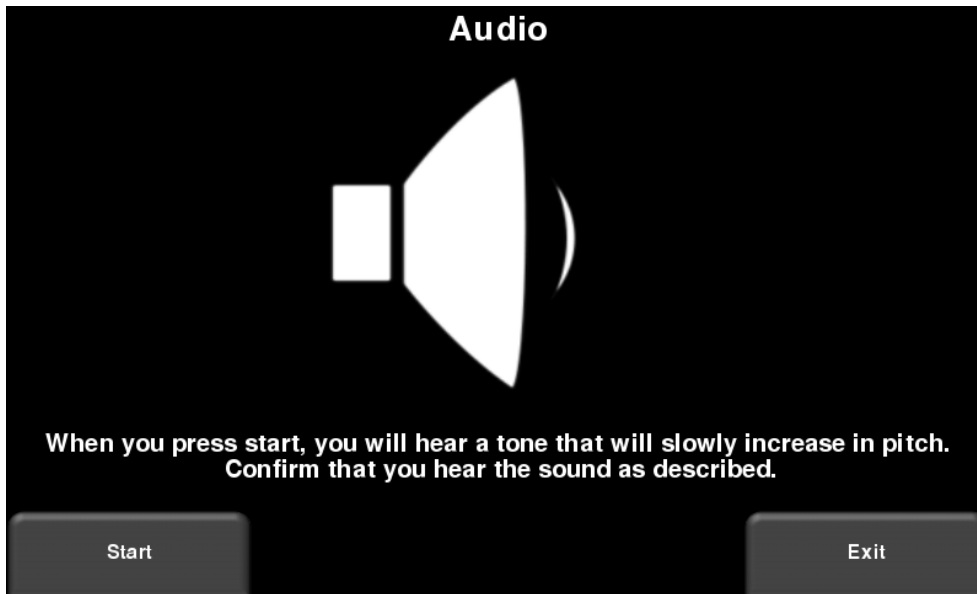

Figure 4-10: Audio Test

Touch Screen

The test checks proper operation of the touch screen (Figure 6-11). It allows you to test the screen (by pressing **Test**) or perform a quick calibration followed by a test (by pressing **Calibrate**). Both involve touching targets on the screen in the allotted time.

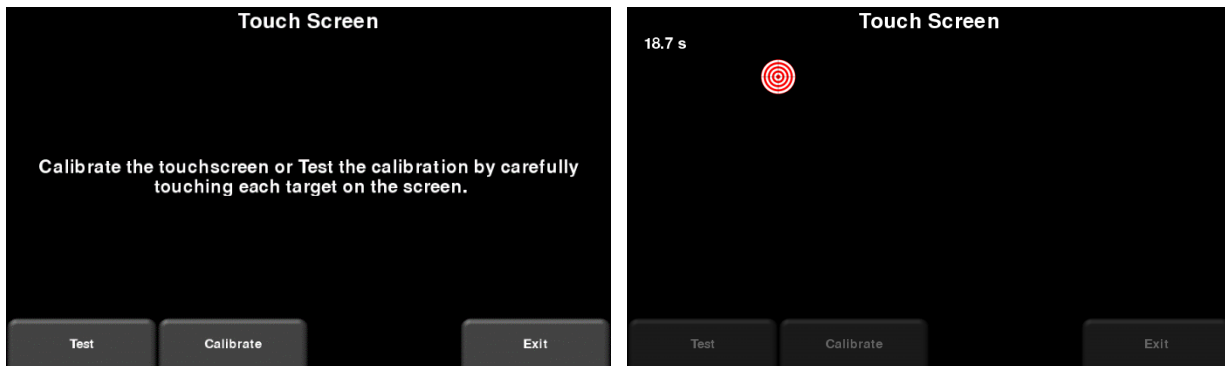

Figure 6-11: Touch screen test on the left, Touch screen calibration test on the right

Sensor Test

This test checks proper operation of the GPR sensor, including the amplitude of the pulse. Once the cart is tipped backwards and start is pressed, it will conduct the test (Figure 6-12). If there are any irregularities, the test will indicate failure.

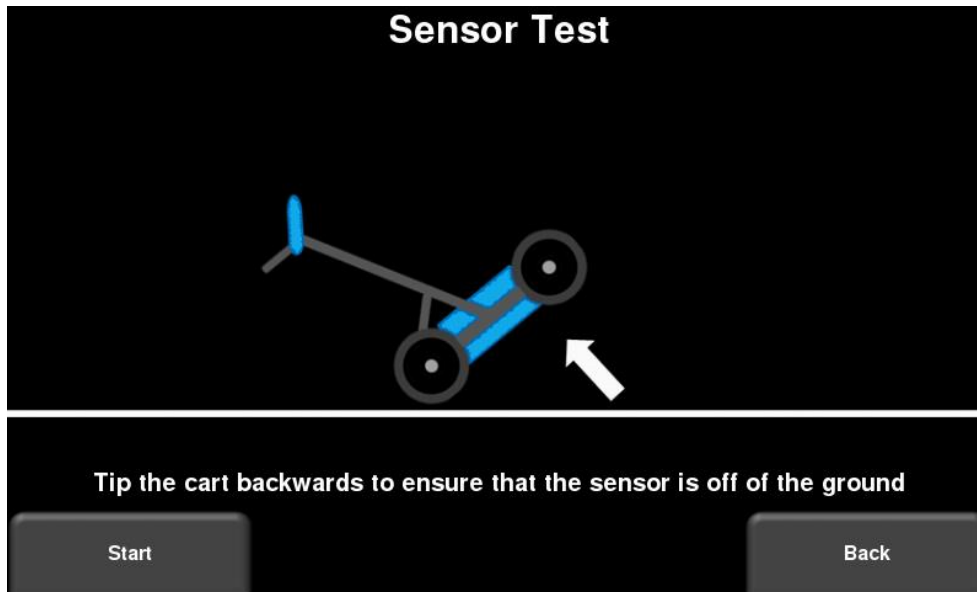

Figure 6-12: Sensor Test

Odometer Calibration

This test ensures that the odometer is calibrated properly for distance. Even though the odometer is calibrated in the factory, you must calibrate it periodically to ensure accuracy. This is particularly important as the calibration can change with different surface materials.

Choose a set distance from the screen, press **Start** and then move the system that exact distance, using a measuring tape or other known distance indicator. Press **Finish** when you have travelled that distance (Figure 6-13).

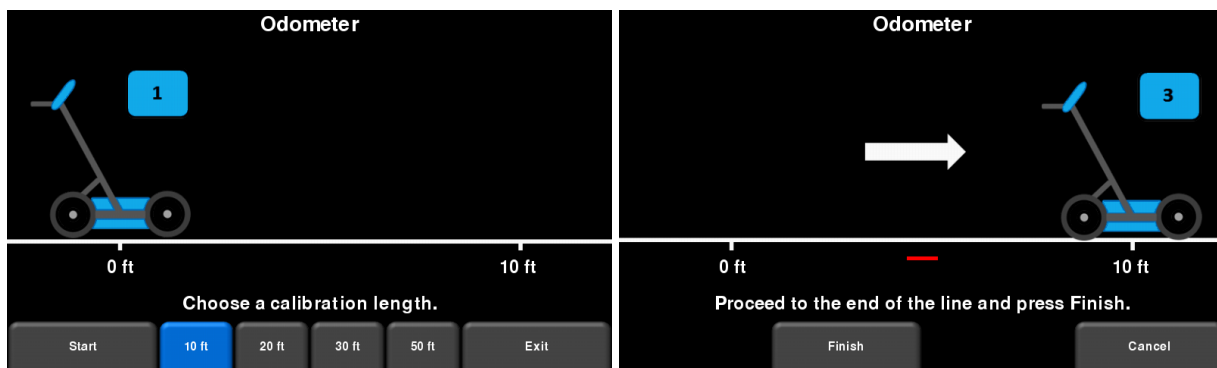

Figure 6-13: Odometer Test. Image on the left shows the screen where the user must select a distance. The image on the right instructs you to move that distance then press **Finish**.

Upon completion, it displays the screen in Figure 6-14. The new calibration value is shown to the right of the arrow in number 1. You can either accept the new value (by pressing '1' on the

keypad) or revert back to the previous value (by pressing '8' on the keypad). If the new value is significantly out of range, the test will fail.

The odometer calibration value is stored in the Display Unit. If the Display Unit is changed, or swapped out, you will need to run the Odometer Calibration test again.

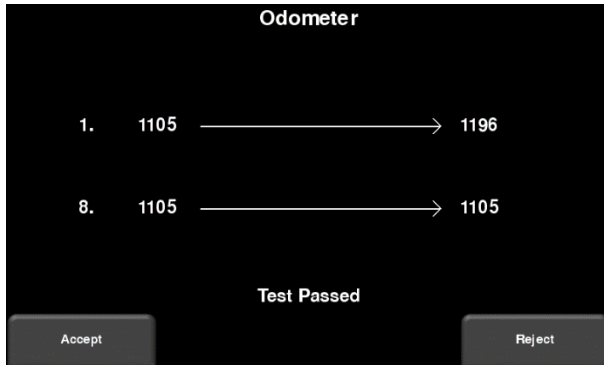

Figure 6-14: Results of Odometer Test

GPS

The GPS test will ensure that the system is communicating properly with the GPS and receiving data. Pressing **GPS** will show the screen in Figure 6-15.

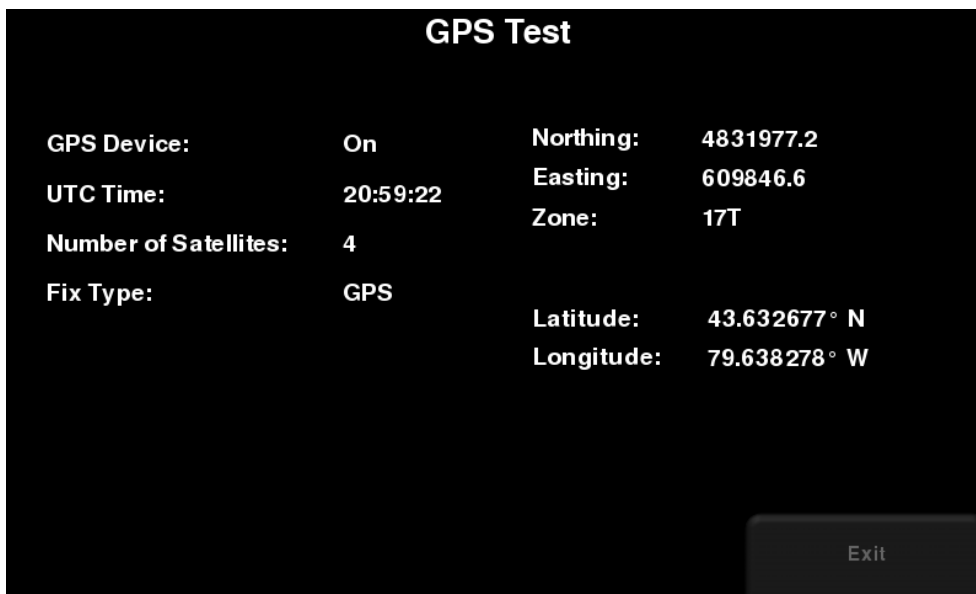

Figure 6-15: GPS Test

The basic position and time information is displayed on the screen. On the screen, the Fix Type notes if there are any corrections being applied, such as DGPS.

Section 7 - GPR Concepts

7.1 Theory

Ground Penetrating Radar (GPR) technology uses radio waves to image objects in the subsurface. GPR systems emit high frequency radio wave pulses and detect the echoes that return from objects within the subsurface. Echoes are produced when the target material is different from the host material (eg. PVC pipe in gravel)

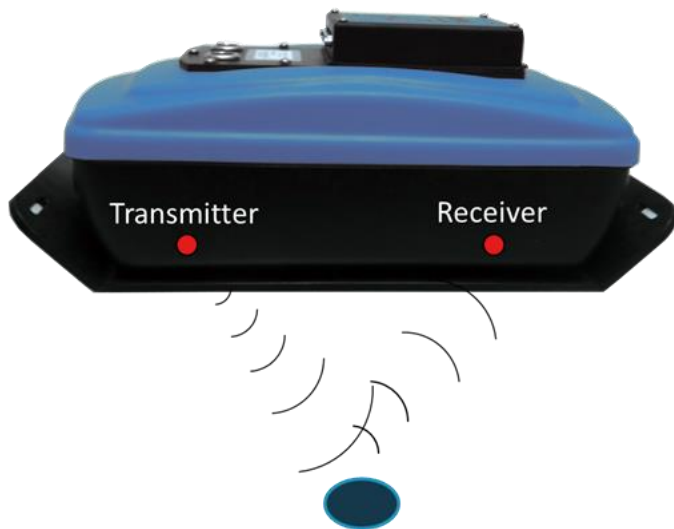

7.2 Hyperbolas

The GPR display shows signal amplitude versus depth (time) and sensor position along a line. This is called a “Line Scan”. Since radar energy radiates in a 3D cone shape rather than a thin beam, a **hyperbola** (or inverted U) is the GPR response from a small point target like a pipe, rock, or a tree root. The radar wave hits the object before and after going over it and forms a hyperbolic reflection that can appear on the record even though the object is not directly below the radar:

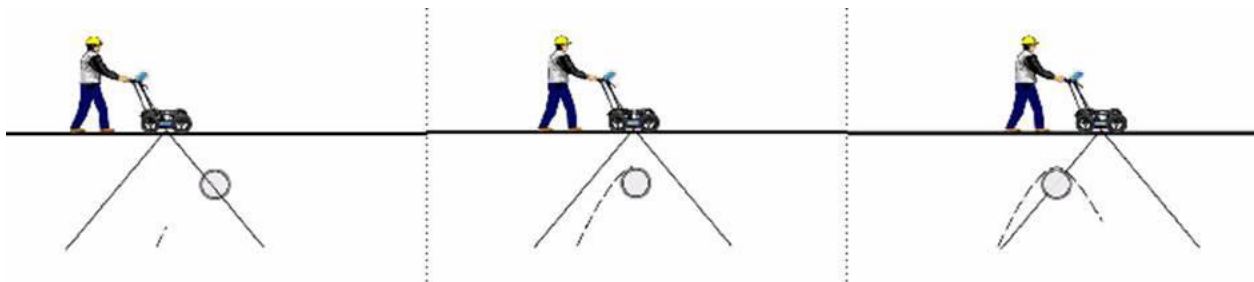

Hyperbolas are best viewed when subsurface targets are crossed perpendicularly or at a 90 degree angle. The actual position of the object is located at the apex of the hyperbola.

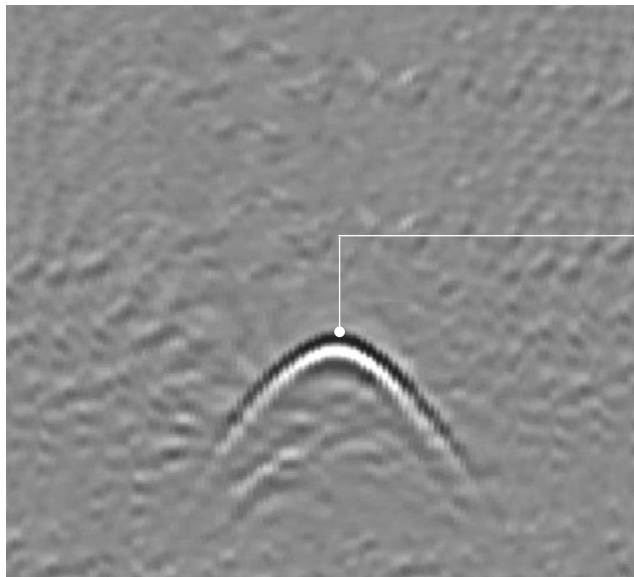

Apex of hyperbola is where
the object is located

7.3 Calculating Depth

Ground penetrating radar records the time it takes a radio wave to travel to a target and back; it does not measure the depth to that target directly. Depth to target is calculated based on the velocity with which the wave travels to the target and back.

To calculate depth:

$$D = V \times T/2$$

Where D is Depth

V is Velocity

T is the Two – way travel time

For the RD1100, velocity is indicated by the Soil Calibration Value, known as Soil Cal. Once the Soil Cal values are set, the measured depths will be determined accurately (Section 8.6.6)

7.4 Soil Calibration values

Below is a table of common subsurface materials and their corresponding Soil Cal. This is only a guideline and there is some variation based on the fact that there can be a mixture of different materials in the subsurface. The soil water content has the biggest influence, by far, on Soil Cal values.

Air	300
Ice	160
Dry Soil	140
Dry Rock	120
Soil	100
Wet Rock	100
Concrete	100
Pavement	100
Wet Soil	65
Water	33

7.5 Air Waves

Some hyperbolas are caused by air wave reflections from objects above ground, such as posts, fences, overhead wires, and trees.

The following image displays how air wave reflections affect data:

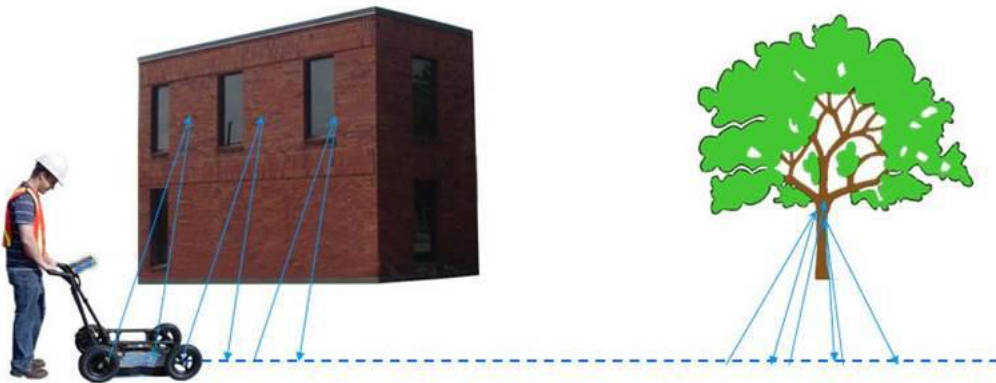

An important part of understanding the data image is learning to recognize these unwanted "air" targets and distinguish them from the targets in the ground. Good field notes are indispensable for helping identify unwanted events on the data.

The best way to identify air reflections is the target hyperbola method. Hyperbolas from above ground objects are wider than objects in the ground and will have a Soil Cal at, or close to, 300.

To learn more, see **Soil Cal** in **Section 8.6**.

Section 8 - Data Collection

GPR data is collected along a straight line, and allows the operator to view it as a cross-section image. The operator can locate a feature and easily back-up and mark the location of that object on the ground. The operator can identify the alignment of subsurface features, check for linearity and acquire accurate depth measurements.

From the main screen, press the **Start** button; you will see the screen shown in Figure 8-1.

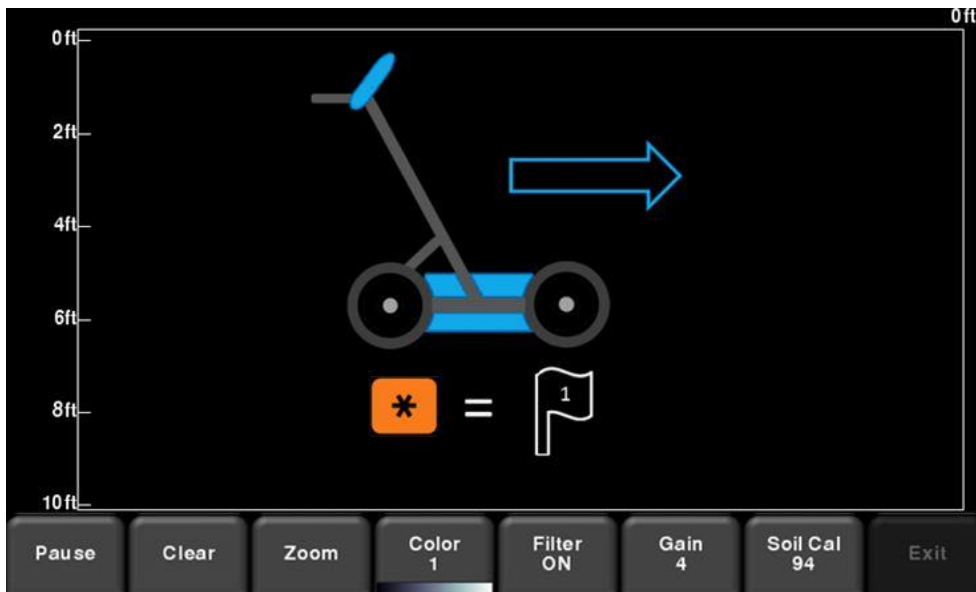

Figure 8-1: Data Collection screen

8.1 Acquiring Data

The system is ready to collect data as soon as you see this screen. As the system is pushed along a straight line, the collected GPR data scrolls onto the screen from the right and moves to the left (Figure 8-2).

The depth scale along the side of the GPR Line image and the position scale along the top of the image are set to Metric or US Standard units based on the setting in the Preferences menu (Section 6.1)

If **Auto-Hide Buttons** is set to **ON** (Section 6.1), the menu at the bottom of the screen disappears as soon as you start collecting new data, thereby maximizing the data display area. When the user stops, backs up or presses a button on the keypad the menu reappears.

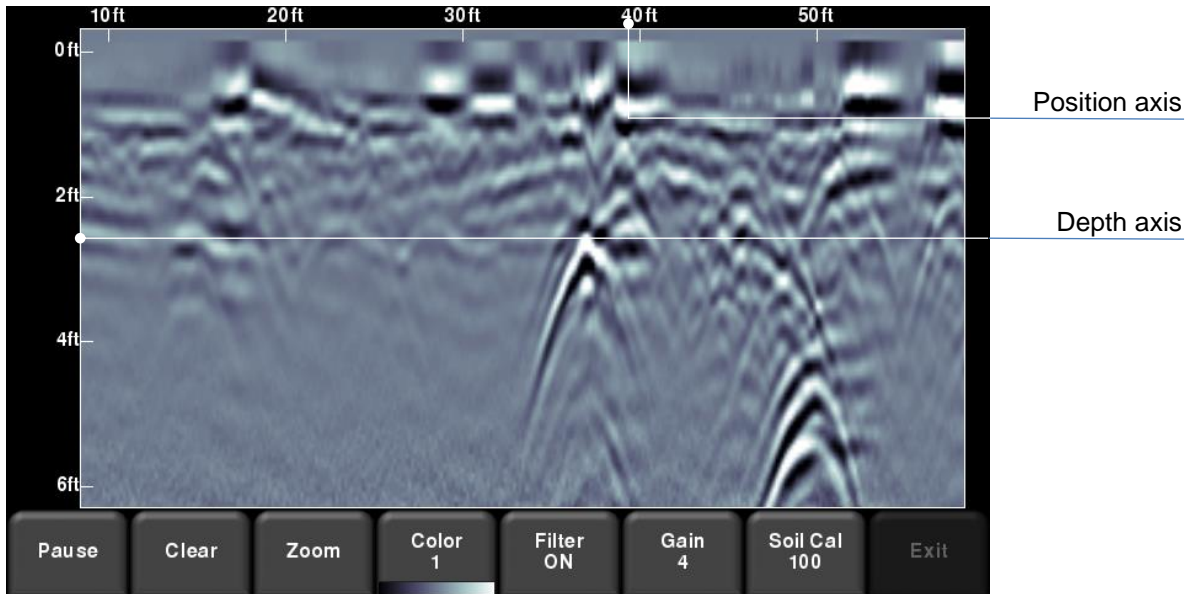

Figure 8-2: Line Scan acquisition mode, showing collected data and axis labels

8.2 Back-up Indicator

Line Scan mode incorporates a back-up feature to enable you to accurately locate targets and mark them on the ground. After acquiring some data on the screen, move the system backwards (Figure 8-3).

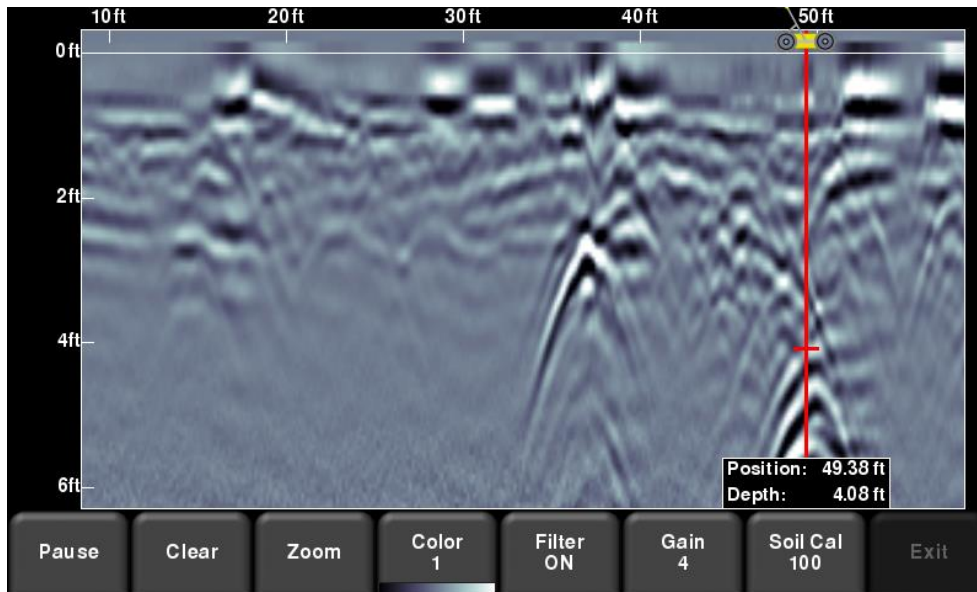

Figure 8 3: Back-up indicator when reversing

During back-up mode, there will be two indicators:

- **Position Indicator:** The red vertical line corresponds to the location at the center of the GPR sensor. As you pull the cart backwards, the Position Indicator moves to mark the current location of the cart in the image and a box appears with the current position, relative to the start of the line, listed as the top number.
- **Depth Indicator:** A short red horizontal line corresponds to the current depth value, as shown in the bottom number in the box. To determine the depth of an object, move the indicator up or down by dragging the horizontal line to the desired location (Figure 8-3). Alternatively, you can also use the **Up** and **Down** arrows on the 4-way directional keypad.

NOTE: make sure you have done a Soil Cal to ensure depth accuracy (see [Section 8.6](#)).

To locate a feature, simply roll the system back along the same path until the red vertical line is exactly over the response (usually a hyperbola). You can mark the location of the object on the surface and continue data collection. Once you reach the point where you initially started backing-up, the system will continue acquiring new data.

You can also obtain depth and position information anywhere on the Line Scan by touching the screen and holding for a second. A cross-hair appears where you touched the screen, with a box displaying the position and depth (Figure 8-4). To get the position and depth information about a different point on the screen, simply touch and drag the box or cross-hair to the desired position.

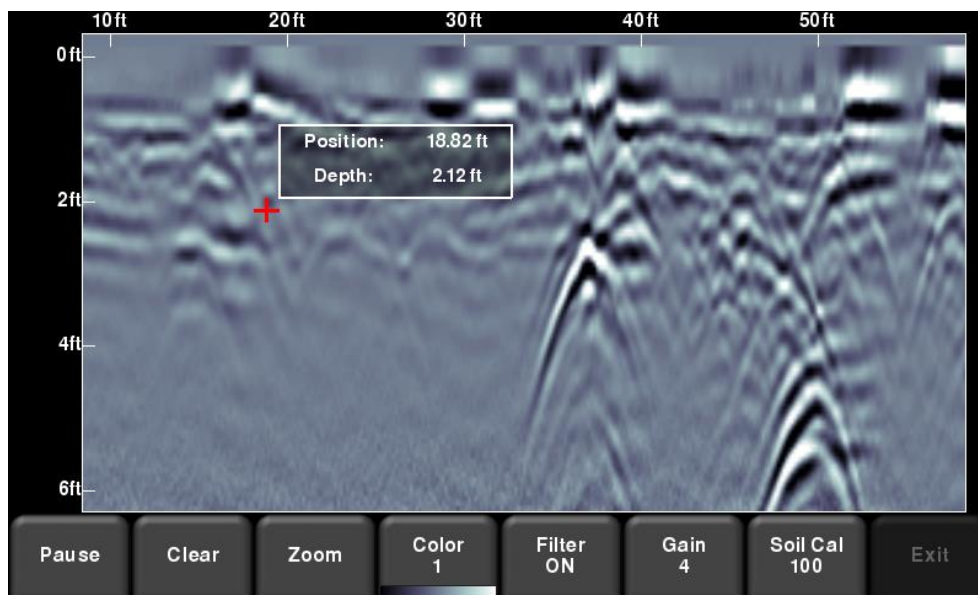

Figure 8-4: Touch screen to get depth and horizontal position at any point

8.3 Flags

Flags are often inserted to mark noteworthy surface features, such as poles, sidewalks, changes in terrain etc. These markers may help you correlate subsurface targets with above ground features.

Pressing the **asterisk** button on the keypad will insert a flag at your current position, either during forward data acquisition or when backed-up. Flags are sequentially numbered (Figure 8-5).

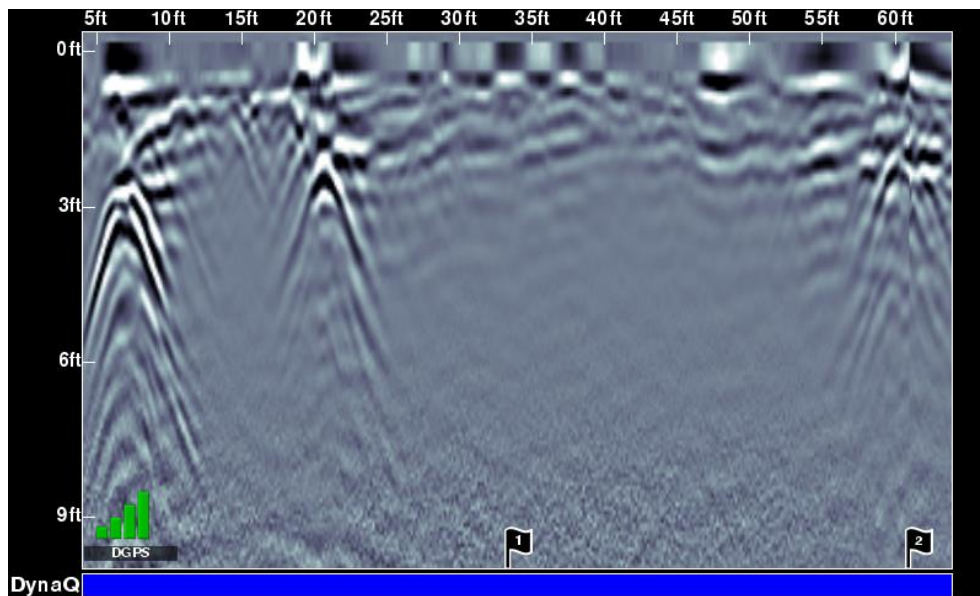

Figure 8-5: Inserting Flags

8.4 Line Scan menu options

All the settings described below change the way the data is viewed on the screen. This can be useful for optimizing the appearance of different features.

Clear

Pressing this button will clear the data on the screen.

Zoom

This button controls the horizontal and vertical scaling of the displayed GPR data. Pressing the **Zoom** button changes the buttons on the bottom menu as follows:

- **Depth** – Pressing **+** and **-** under the **Depth** button allows you to change the display depth of the data. This is commonly referred to as the depth window. The pre-set values range from 1m to 8m (3' to 25'), see Figure 8-6.

If the data was collected with a shallower depth, the depth setting can still be increased after the fact, when reviewing the data. In general, it is recommended that you set your displayed depth to 1.5 - 2 times the depth you expect the deepest target to be.

- **Position** – Pressing + and - under the **Position** button allows you to change the length of data display on a single screen. This is also known as horizontal scaling. The pre-set values range from 10m to 30m (25' to 100'), see Figure 8-7.

One reason for setting this to 30m would be to fit more data on the screen and look for consistency among hyperbolas that were crossed.

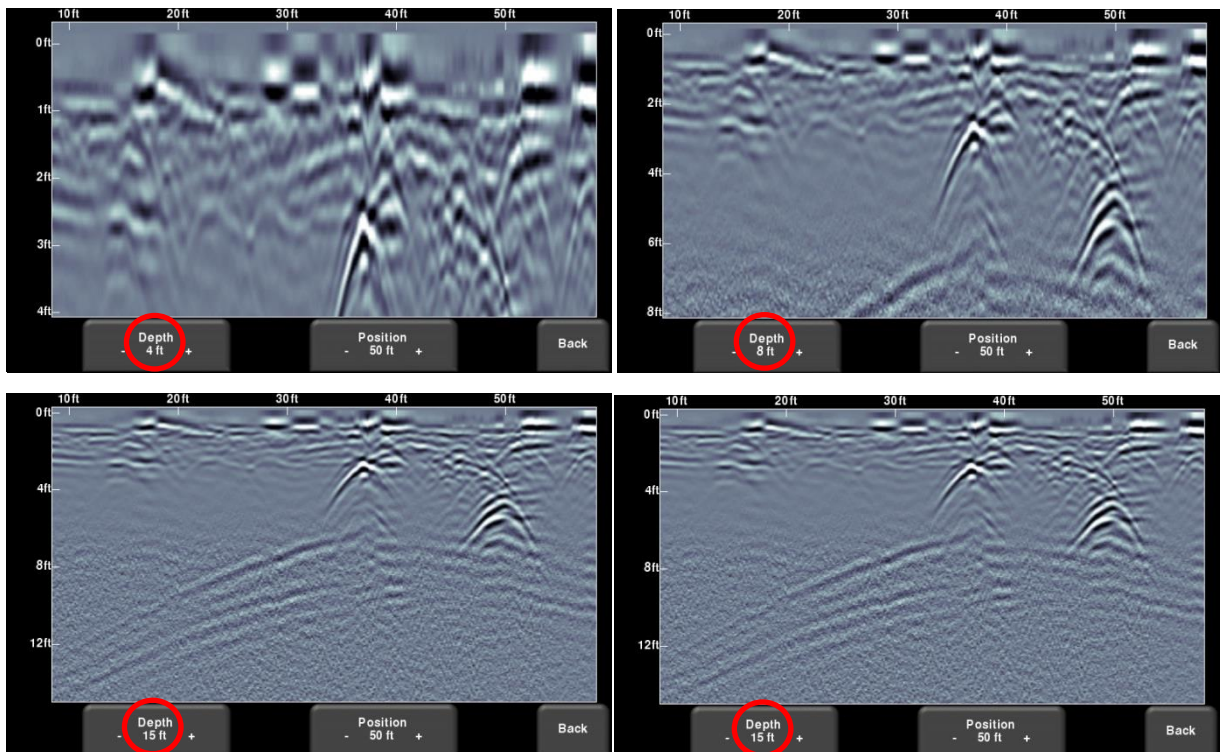

Figure 8-6: Varying displayed depth

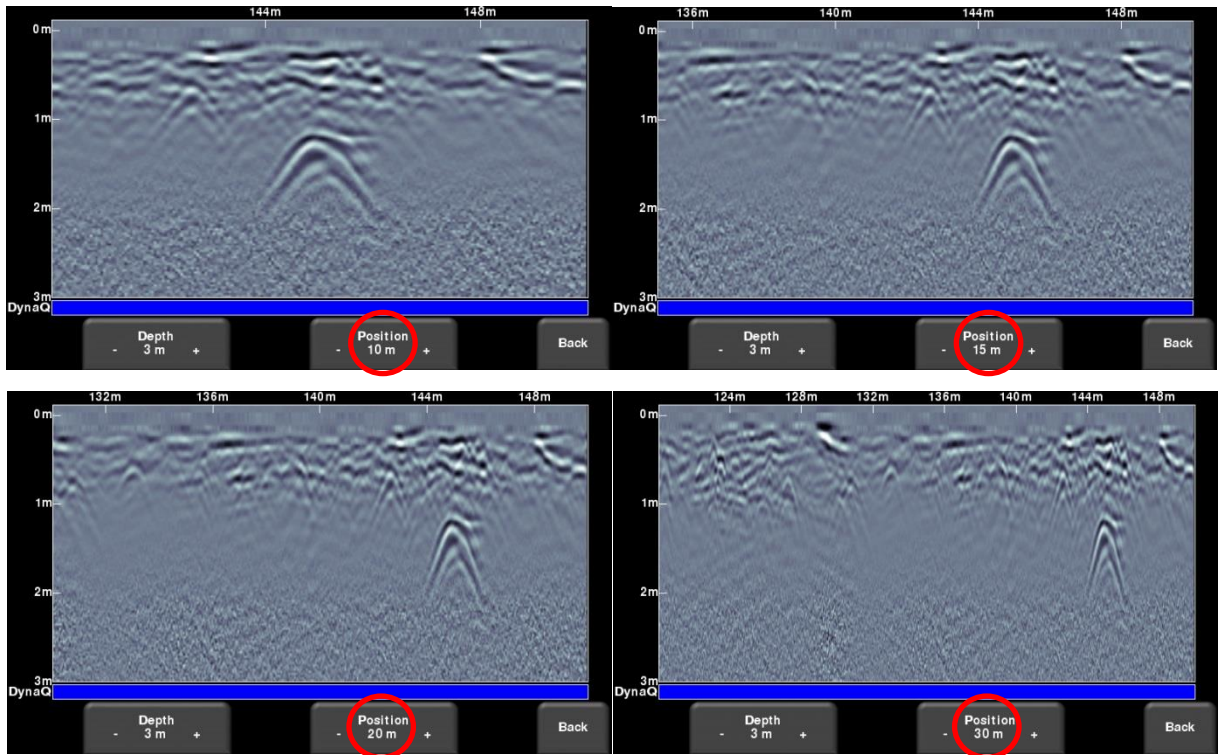

Figure 8-7: Varying position, or horizontal scaling

Color

Pressing **Color** changes the color palette for the GPR Lines. There are 8 different color palette options. The image is automatically re-displayed as the color palette changes. A few sample color palettes are shown in Figure 8-8.

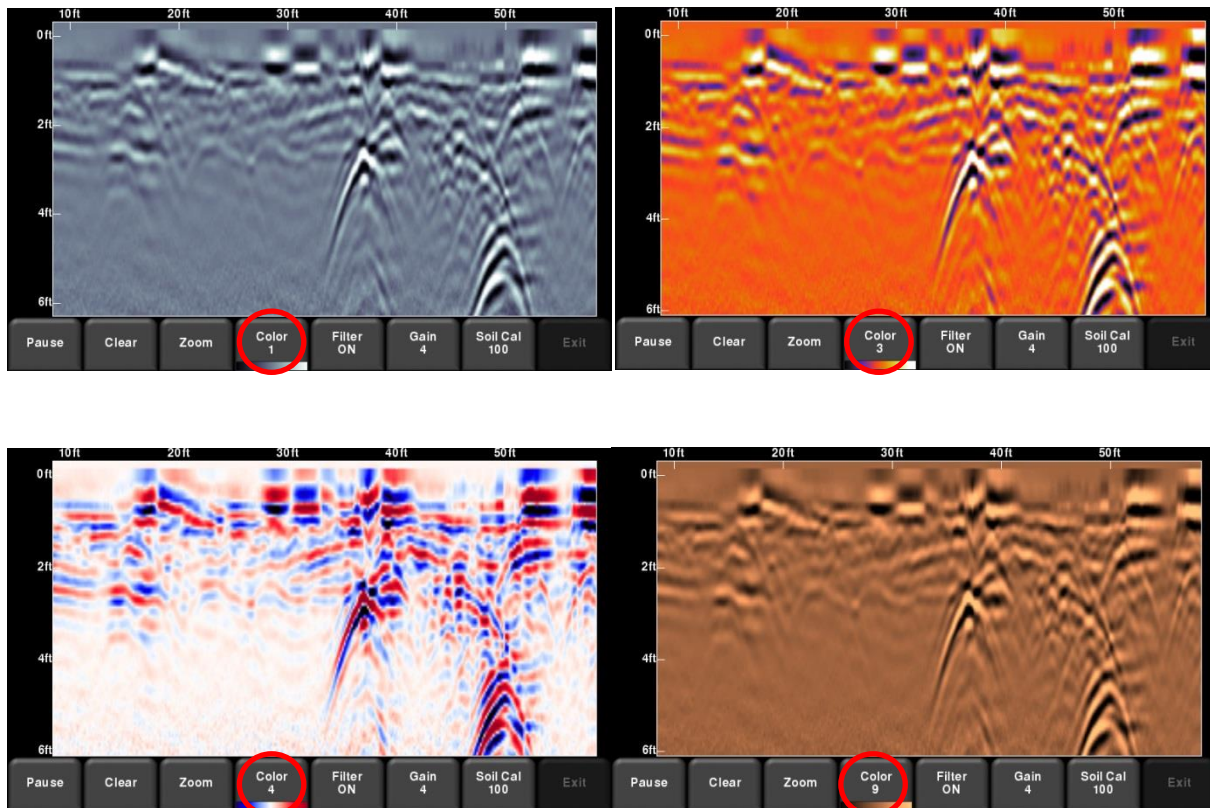

Figure 8-8: Changing Color palettes

Filter

When the filter is **ON**, flat-lying responses in the data are filtered out so that hyperbolic responses from objects are enhanced (Figure 8-9). Filtering also helps identify shallow targets that might be masked by the strong signals at the top of the image. However, it will also filter out other flat-lying responses, such as soil boundaries, so be careful when using this option if your target is flat. The filter is set to **ON** by default.

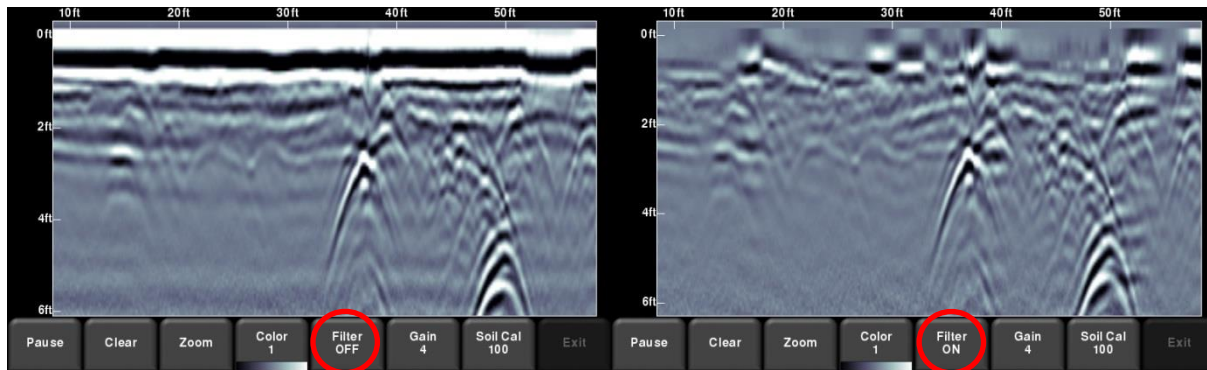
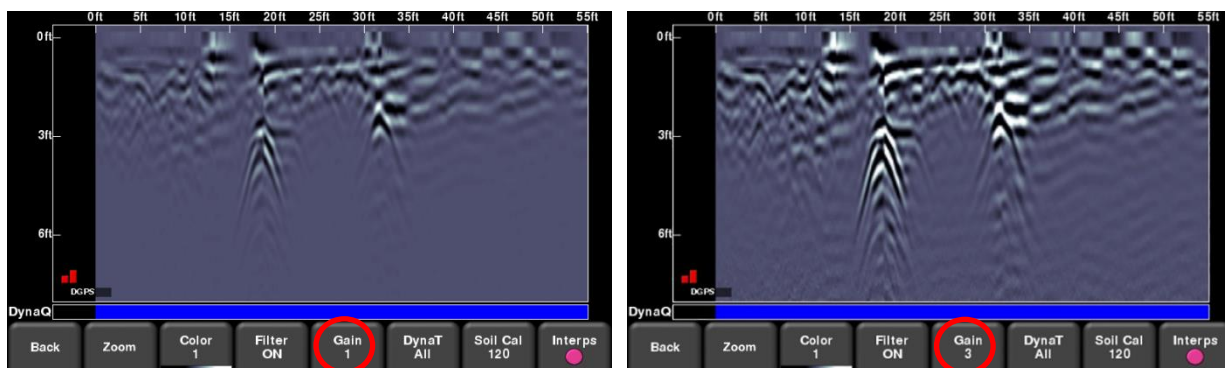

Figure 8-10: Left image shows Filter **Off**, while the right shows the same data with the Filter **On**

Gain

Since the material being scanned absorbs the GPR signal, deeper targets return weaker signals. Gain acts like an audio volume control, amplifying signals and making deeper targets appear stronger in the image. Gain values vary from 1 to 9 where 1 means a minimal amplification has been applied and 9 means that maximum amplification has been applied. Pressing this button increments the gain; once you reach 9 it cycles back to 1.

Avoid over-gaining the data as it can make interpretation difficult. In general, soils that are more electrically conductive (eg. clays) will require a higher gain compared to soils that are less electrically conductive (eg. sand).



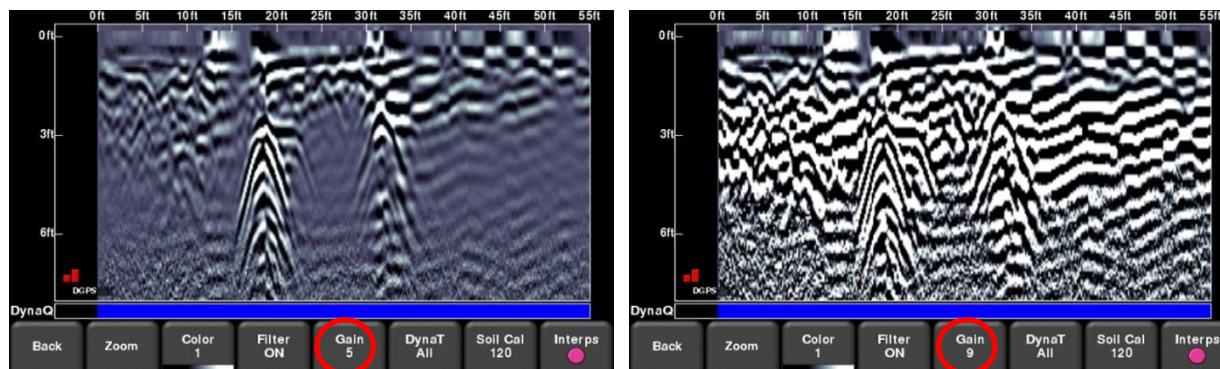

Figure 8-10: Varying the Gain

Soil Cal

Soil calibration (also known as velocity) is a parameter used to ensure that measured depths are accurate. The best way to ensure this is by using the hyperbola-fitting method, since it is based on data collected in the area.

Crossing linear targets like pipes or cables at a 90 degree angle produces a hyperbola suitable for soil type calibration. The Soil Cal value obtained will be used to compute a depth estimate of a target.

NOTE: These depths will be *incorrect* if the soil type is calibrated on a target hyperbola produced at an oblique angle, rather than 90 degrees.

Once you have a hyperbola on the screen from a subsurface target, press **Soil Cal**. The menu at the bottom of the screen will change, giving you the option of either specifying a Soil Type or adjusting the Soil Cal using the hyperbola-fitting method (Figure 6-11). These options are explained as follows:

- **Soil Types** – If there are no targets to calibrate to, and you know the type of soil, press this button to vary between the following mediums, with the pre-set Soil Cal value shown in brackets
 - very wet (60)
 - wet (80)
 - moist (100)
 - dry (120)
 - very dry soil (150)
 - air (300)

NOTE: you cannot “apply” and accept the **air** value. This is only to fit the hyperbola to determine if it is an air wave (Section 7.5)

- **Soil Cal** – allows you to use hyperbola-fitting to determine a more accurate Soil Cal. The options are slightly different, depending whether or not you are in backup mode.

If the backup indicator is on the screen when you press Soil Cal, then moving the RD1100 back and forth will adjust the vertical position indicator. The operator will typically move the system until it is over the hyperbola in question. You can then adjust the vertical position of the horizontal scroll bar by touching the screen and dragging it, or using the up & down keypad arrows. Move the scroll bar such that it lines up with the top of the hyperbola in question (Figure 8-11).

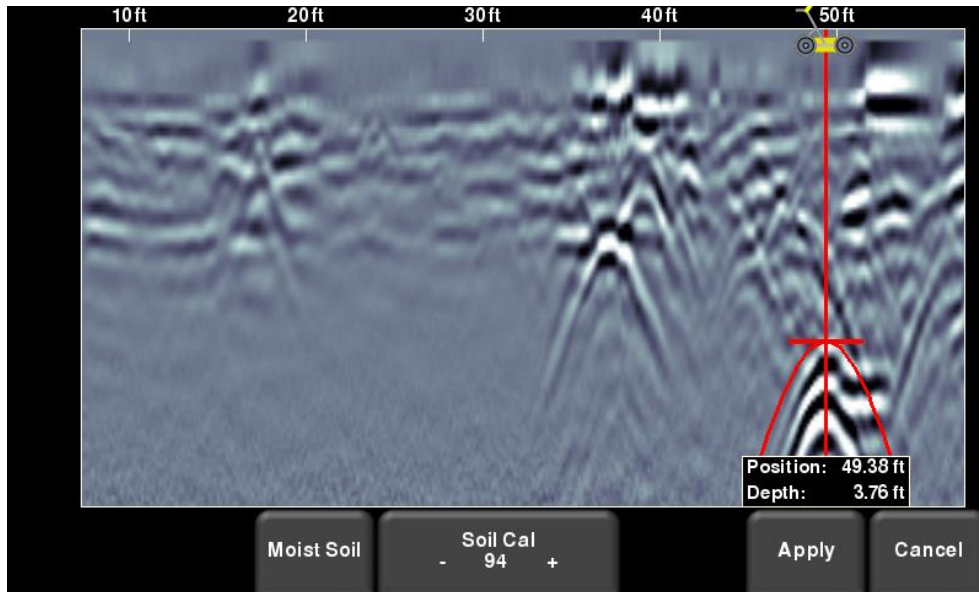

Figure 8-11: Adjusting Soil Cal while in backup mode

Alternatively, if you press **Soil Cal** while you are collecting data or have pressed **Pause**, you will see a red hyperbola in the middle of the screen. Drag the hyperbola such that it lies over a real hyperbola from the ground (Figure 8-12). You can use the 4-way keypad arrows to fine tune the movements.

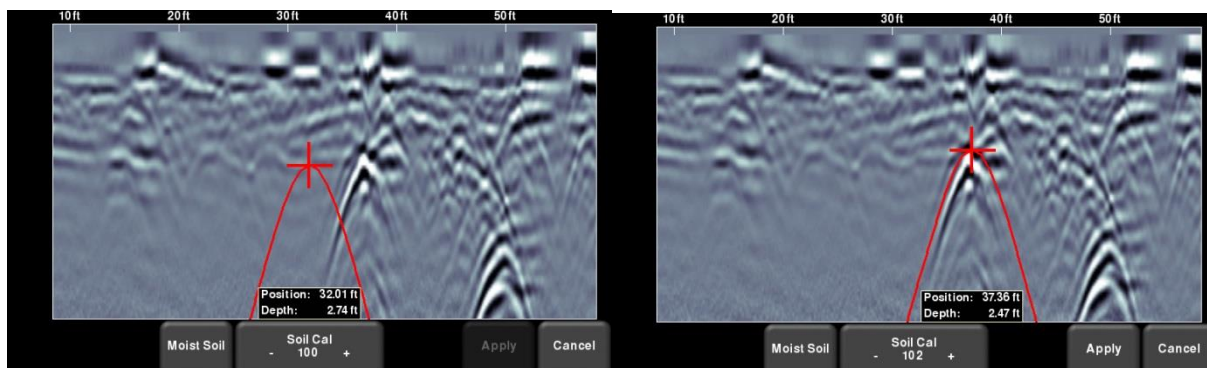

Figure 8-12: Pressing **Soil Cal** displays a red hyperbola (Left). Then move the hyperbola so that it lies over a hyperbola from the ground and adjust the shape (Right)

For either scenario above, once the red hyperbola is properly positioned, you can now use the **+** and **-** buttons on the Soil Cal button to widen or tighten the shape. Once the shape is matched (Figure 8-11 and right image of Figure 8-12), you now have the correct Soil Cal and the measured depths will be most accurate. Press **Apply** to use this value.

If you get a Soil Cal near 300, this could be an Air Wave (Section 7.5), and you should calibrate to a different hyperbolic response.

Pause button

The Pause button allows you to stop data collection temporarily, and then resume again, without clearing the data from the screen. This might be useful if you want to collect a series of parallel lines over a target and show all the passes on the screen for comparison.

Once you collect some data, press **Pause**. You can now move the LMX200 without data scrolling on the screen. When you are ready to resume collecting data, press **Start**. You will see a thick, red vertical line, corresponding to when you hit the Pause button and then restarted (Figure 8-13).

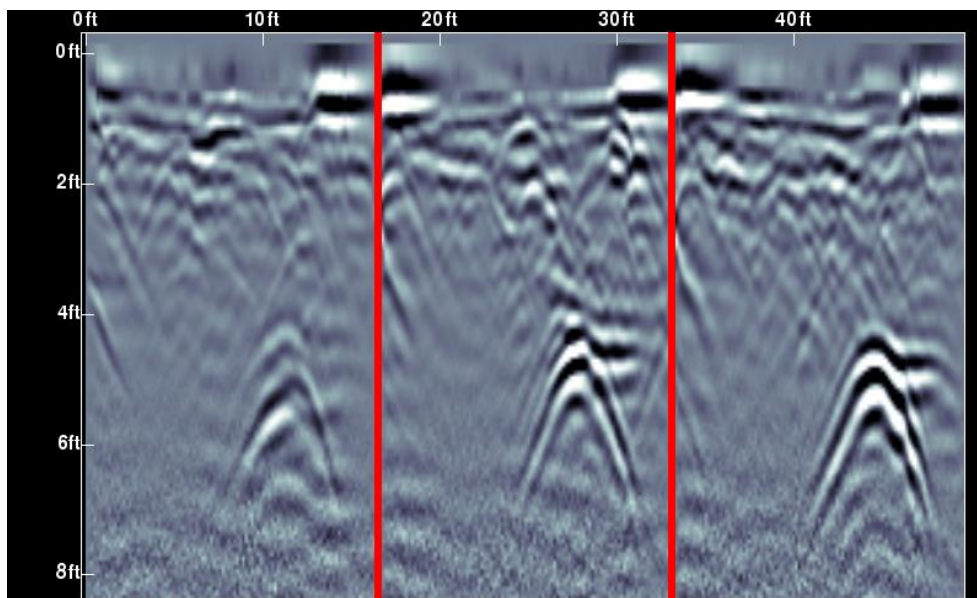

Figure 8-13: Pressing Pause and resuming data collection.

Drawing arrows

The RD1100 offers the ability to draw arrows on the screen to highlight features. Touch the screen where you want the head of the arrow to appear, and then swipe away in the direction of the shaft. Alternatively, if you just tap the screen, it will insert a vertical arrow pointing up at that

position. In the example in Figure 8-14, the user touched near the hyperbolas, then swept their finger towards the top to create the arrows. Touch any arrow to remove it.

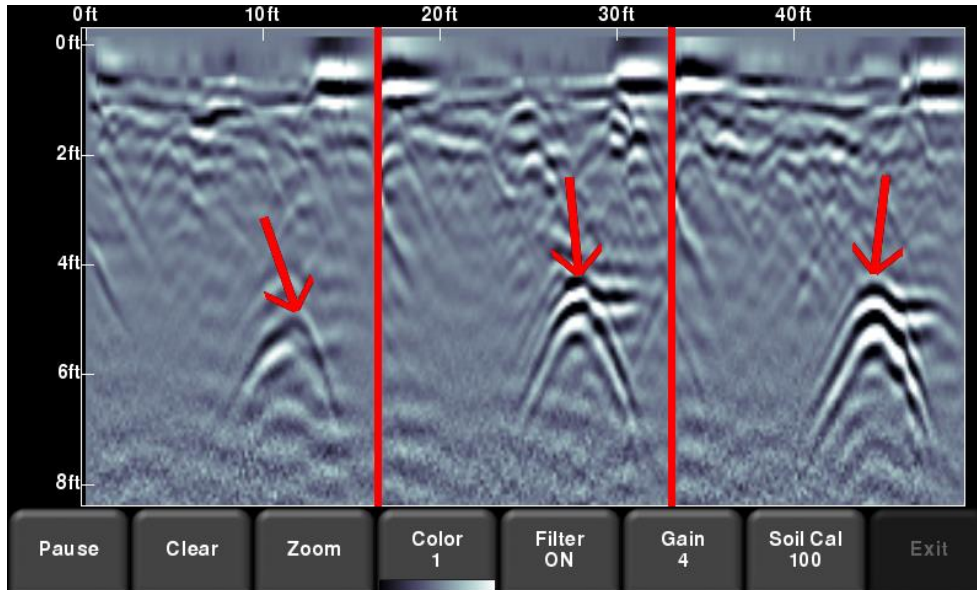

Figure 8-14: Drawing arrows on the screen to highlight targets and features

Saving images as screenshots

Pressing the Camera button will take a screenshot of whatever is on the screen, and save this as a .JPG file. See Section 9 for more details on screenshots and e-mailing mini-reports.

Section 9 - Screenshots & Mini-reports

9.1 Capturing Screens

If you would like to save an image of the current screen press the **Camera** button on the Display Unit. This saves the screen as a Screenshot image (.JPG), which can be viewed in any third-party viewing software.

If you are not connected to a WiFi network, a message appears confirming the filename of the saved image (Figure 7-1).

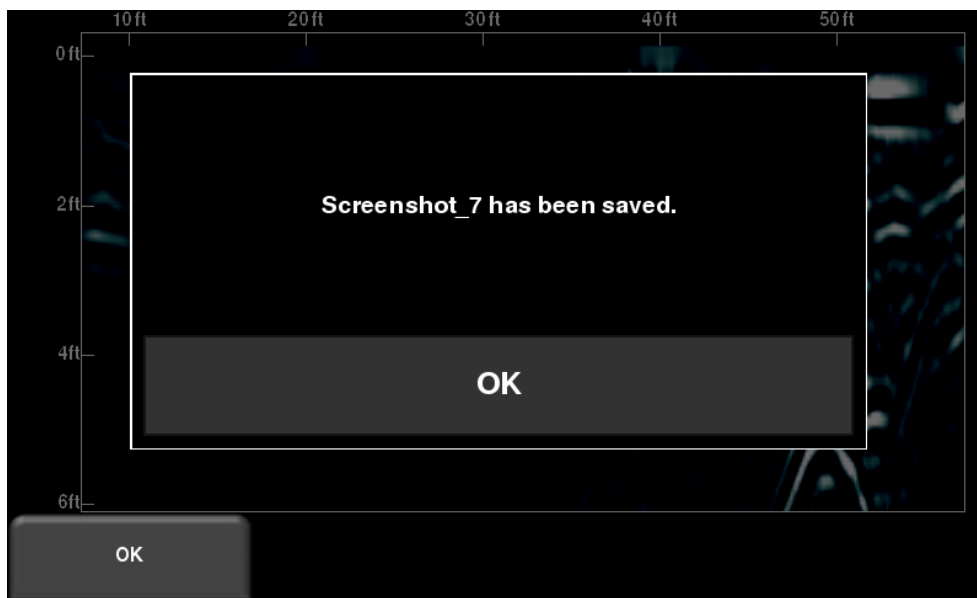

Figure 9-1: Message displayed after pressing the camera button on the Display Unit to capture the screen (no WiFi present).

If you are connected to a wireless network and have a sending e-mail address configured, the user will see the message in Figure 9-2, asking if you would like to email the screenshot and prompts you to enter the email address. The email address defaults to the last one entered.

Tapping on the address box brings up an on-screen keyboard and allows you to enter a new email address. Pressing the “...” button to the left of the e-mail address displays the last 5 e-mail addresses used, allowing the user easily to select a recent email address, rather than re-entering it.



Figure 7-2: Message after pressing the Camera button on the Display Unit to capture the screen with WiFi enabled and a connection to a wireless network. The user can enter an email address to send the mini-report to

9.2 Screenshot Gallery

The screenshot gallery allows you to manage all screenshots saved on your RD1100. If you have at least one screenshot saved, you will be able to enter the gallery; otherwise the Screenshot Gallery button will be greyed out.

Press **Screenshot Gallery** from the main screen, you will see the image in Figure 9-3.

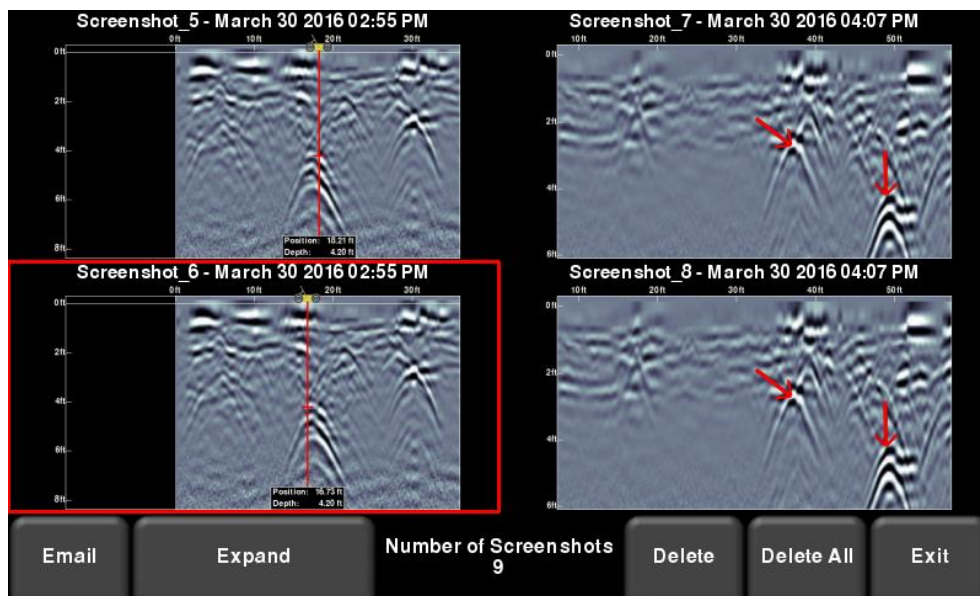

Figure 9-3 – Screenshot Gallery – Tiled View

The number of total screenshots is shown in the bottom middle of the screen.

If you have more than four screenshots saved, you can view the others by either swiping on the screen (right and left), or using the 4 way directional arrows. To select a particular screenshot, touch the screen directly, or use the 4 way directional arrows. From here you have the option to:

Email – Pressing this will allow you to e-mail the screenshot as a mini-report, provided you're connected to a WiFi network and have a sending e-mail address saved on the system. You will see the same e-mail prompts as shown in Section 9.1.

Expand – This will enlarge the selected screenshot to full screen (Figure 9-4)

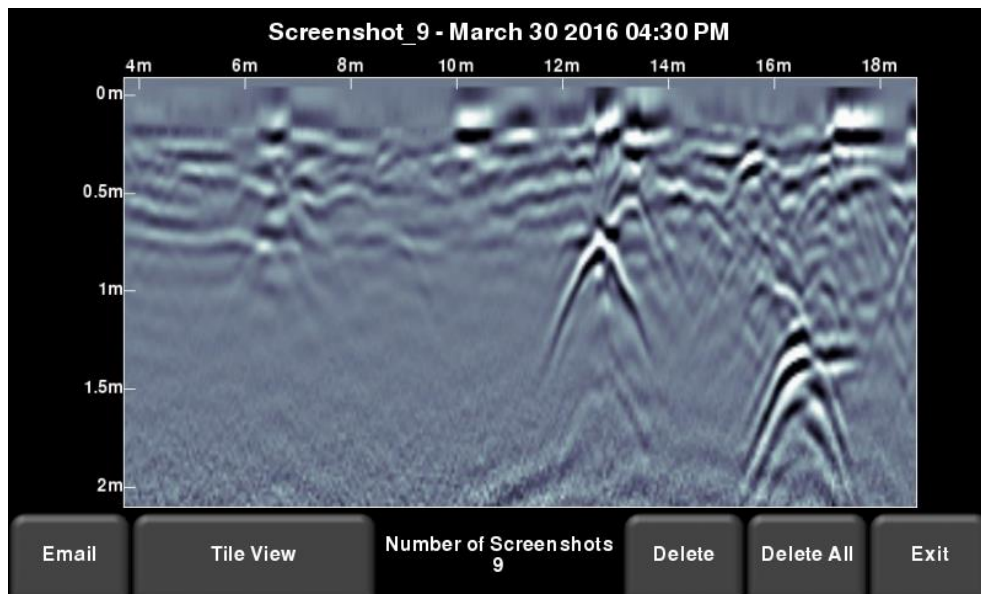

Figure 9-4 – Screenshot Gallery – Expanded View

Press **Tile View** to return to the view showing four per page.

Delete – This will delete the selected screenshot. A confirmation message will appear asking if you want to proceed with this.

Delete All – This will delete ALL screenshots. A confirmation message will appear asking if you want to proceed with this.

Exit – this will return you to the main screen. The next time you enter Screenshot Gallery it will show the same view that you left with, Tiled or Expanded.

9.3 Using the Hotspot on your SmartPhone

If a Wi-Fi signal is unavailable, you may be able to use your Smartphone as a Wi-Fi access point, by creating a Personal Hotspot. If you are experiencing difficulty connecting to a cell phone Personal Hotspot, ensure that the phone is in discovery mode while connecting. On an iPhone (iOS 9.0), for example, this involves going to **Settings - Personal Hotspot**. Ensure that the Personal Hotspot setting is turned on, and wait on this screen until the RD1100 connection has been established. Once you have received confirmation on the Display Unit, the cell phone can resume normal use.

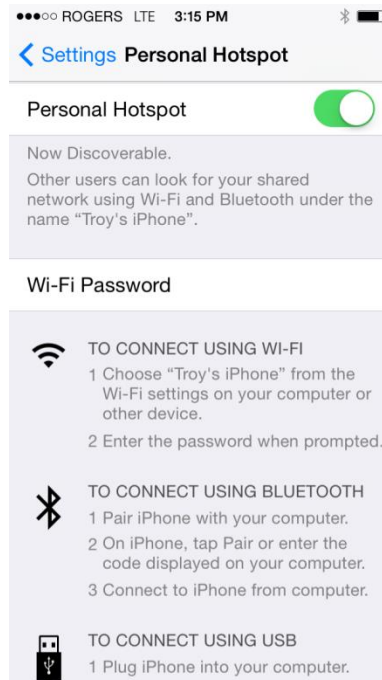

NOTE: When setting up a Personal Hotspot, you may be disconnected from any WiFi networks. Vice-versa, if you have a Personal Hotspot setup, attempting to connect to a WiFi network may disconnect your personal hotspot.

9.4 Mini-Reports

When a screenshot is e-mailed, it is sent as part of a mini-report. This mini-report also contains a table with information about the collected data including the settings used, date & time (Figure 9-5)

RD1100 Mini Report

Screen Capture Number	3
Date Collected	March 30 2016 2:21 PM
Mode	Line Scan
Depth	10.0 ft
Line Color Palette	1
Filter	ON
Gain Level	3
Soil Cal	Wet Soil (79)

RADIODETECTION®

Your screen capture is attached to this email.

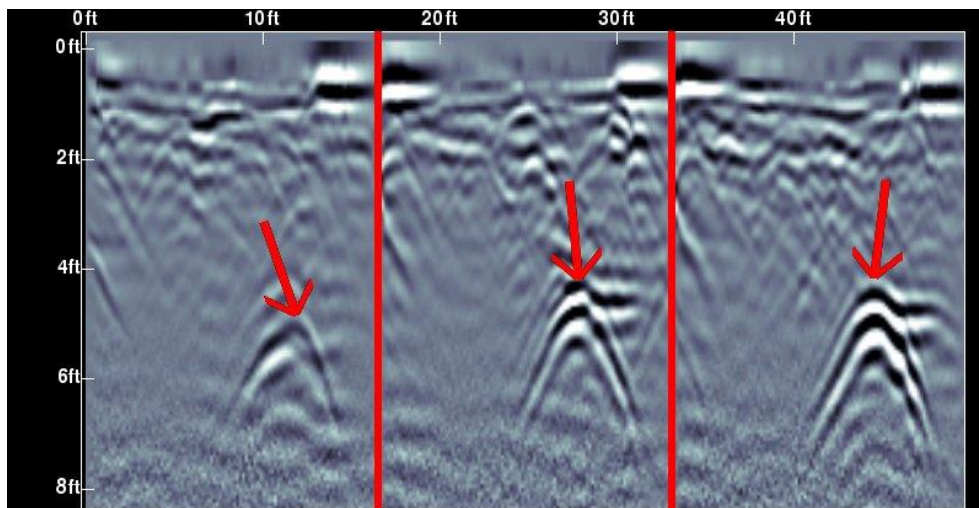

Figure 9-5: Example of a Mini-Report

Section 10 - Transferring Data to a PC

Screenshot images can be exported to a PC by inserting a USB drive into the USB port (Figure 10-1).



USB-memory stick

Figure 10-1: Insert a USB memory stick into the USB port on the Display Unit to export data.

Once the USB drive is recognized, a message will appear telling you that a drive has been inserted and ask you if you wish to export your data to it (Figure 10-2). Click **Yes** to begin the transfer

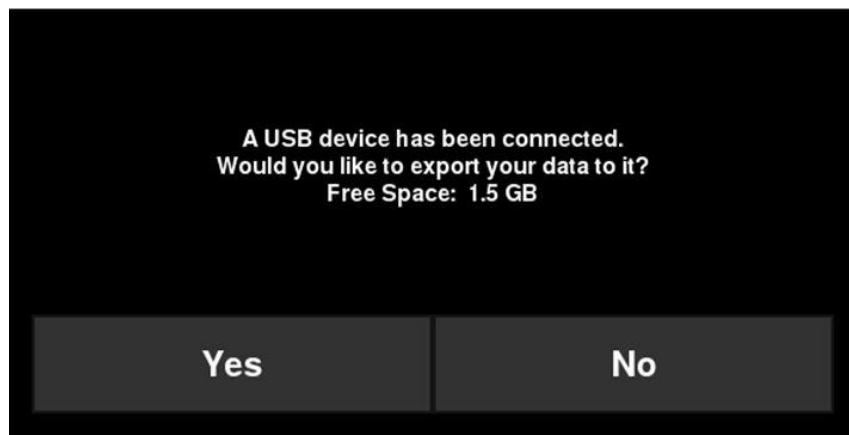

Figure 10-2: When a USB drive is connected to the Display Unit, a message opens asking if you would like to export all your data to it.

The directory structure on the USB drive can be viewed on your PC, and will look as follows:

- GPR Data
 - RD1100
 - Export01
 - Screenshots
 - All Screenshots as .JPG files
 - System Info
 - System Summary.pdf
 - RD1100.kmz
 - ExportXX

Each successive export of data will create a new directory called ExportXX, where XX is incremented by 1 from the previous directory.

All screenshots are saved as .JPG files in the Screenshots folder.

The System Info folder contains a system summary diagnostic report.

If the GPS data was available during screen capture, those Screenshots are geo-tagged and a .kmz file is generated. This file can easily be opened in Google™ Earth, and shows you the geographic position of those screenshots.

Section 11 - Troubleshooting

The RD1100 system is designed to minimize user problems; however, all electronic devices are subject to possible failure. The following are troubleshooting hints which can be referred to if your system fails to operate.

11.1 Power Supply

The most common problem that can occur while trying to run the system is insufficient power. The battery may be dead, have a low voltage or the fuse may be blown.

Once boot up is complete, the color of the LED (see Figure 5-1) indicates the amount of battery power remaining:

- Green = 20% to 100%
- Orange = 10% to 20%
- Red = 0% to 10%

You can check the battery voltage with a voltmeter. Try to do this while the system is still attached to the Cart to get a true measure of the voltage while under load (it will be necessary to open the battery case and connect the voltmeter to the positive and negative battery terminals). A fully charged battery will show a voltage of 13.8V, whereas a voltage of 10.8V or lower will not power the system. If the battery has a low voltage or seems dead, try using another battery (if available), or give the battery a good 12-14 hour charge and try running the system again.

If the battery does not charge up to 12 Volts or more, it should be replaced.

Batteries are fused to protect the system. Open the battery case and check that the 10 Amp fuse is OK. If necessary, replace it with one of the spare fuses available inside the battery case.

If the battery seems OK but the system still does not power up, check the battery cable connections and inspect the battery cable for damage.

11.2 System Communications

If the battery is OK and the Display Unit turns on but the GPR sensor does not scan, there may be a communication failure between the Display Unit and the GPR sensor. If an error occurs, an error message will appear. Power Off the system and disconnect the battery.

Make sure the display cable is not damaged, all pins are straight, and there is no dirt or debris in the connector. Ensure that the cable connections are tightly secured. Vibrations can sometimes cause the cable connections to loosen slightly and break contact, leading to errors. Disconnecting the cable and reconnecting it may provide a better contact and solve the problem. Plug in the battery, turn on the system and try scanning again.

If the Battery, Battery Cable and Display Cable are OK, the problem is either a failure of the Display Unit or the GPR sensor. These units have no user-serviceable parts so they will have to be returned to the vendor for inspection and repair.

11.3 System Overheating

The RD1100 GPR system is designed to operate to a maximum *internal* temperature of 70°C or 158°F. In situations of high ambient temperatures or long exposure to direct sun, this maximum internal temperature may be exceeded and cause the system to fail.

If you suspect that the GPR sensor is overheating, shut it off and give it a chance to cool down in a shady location before trying to run it again.

If the situation is such that the high temperatures or direct sun cannot be avoided, putting some sort of shade over the GPR sensor may help to reduce the internal temperature.

11.4 Display Unit Problem

The Display Unit, which is weatherproof and rugged, should be handled in much the same way as a notebook computer is. If the Display Unit does not power up, check the battery power and all cable connections. If that doesn't work, contact the vendor.

11.5 Wobbly Wheels

Over time, a wheel may become wobbly, in which case you will need to tighten it manually.

For the rear right wheel only (which is connected to the direct drive odometer), insert a large slotted screwdriver into the end of the axle (there's already a slot there for it) and use a large wrench to slightly tighten the wheel nut. The nut only has to be turned slightly, 1/8th - 1/16th of a turn is usually enough. Spin the wheel to make sure it is still free and not too tight.

11.6 Creating a Test Line for Data Quality

After receiving the system and getting comfortable with its operation, one of the best ways of detecting any problems is to collect a line of data at a convenient, easily accessible location. The line does not have to be too long but long enough to fill one screen is a good guide. This data line should be saved electronically and perhaps plotted out on paper and dated. If there is a suspected problem with the system later, this test line could be re-scanned and compared with the earlier results.

NOTE: When comparing data, take weather and environmental conditions into account, as changes can skew the comparisons slightly.

11.7 Contacting the Vendor for Service

When returning the system to the Vendor, have the following information available:

1. GPR sensor Serial Number displayed in the System Information screen (under System Test)
2. A brief description of when the error is happening and the operating conditions (temperature, humidity, sunshine, system settings, etc.).

3. system_summary.pdf – this is downloaded to your computer during data export (Section 10)

Section 12 - Care and Maintenance

12.1 Battery Care

The RD1100 uses a 9-Amp-hour, 12-Volt sealed lead acid battery. It is fused with a 10 Amp fuse to protect it from short circuit damage.

The battery unit should run the RD1100 continuously for 6 hours before recharging is necessary. If long days of data surveying are typical, a second battery may be useful.

The battery is strapped onto the cart base and is normally recharged without removing it from the cart. However, the battery can be easily removed for maintenance or for recharging, if required.

If batteries are maintained in a charged condition they will give long life and reliable service. Improper use and lack of maintenance will greatly reduce their life.

Sealed lead acid batteries should **NEVER** be left in a discharged condition for any period of time. Charge the batteries as soon as possible after use.

Charge the battery at room temperature whenever possible.

The RD1100 has a voltage monitoring circuit that will turn off the unit when the input voltage drops below 10.8 volts.

If a battery has been deeply discharged or left in a discharged condition for some period of time it may not accept charge immediately when it is connected to the charger (the fast charge light will not illuminate). If the fast charge light does not come on within 6 hours the battery should be considered damaged and should be discarded.

Do not assume that a battery that is still charging after 8 hours is nearing the end of its charge cycle. Typical charging time for an empty battery is 12-14 hours from the start of fast charge.

Ensure that the batteries are fully charged before storing. If practical, store the batteries in a cool place. 10°C (a refrigerator is ideal), but make sure the temperature is not likely to drop below -30°C or the electrolyte may freeze and possibly split the case.

12.2 Cable Care

1. The cable connectors as well as the connectors on the GPR Sensor and Display Unit need to be kept clean and free of dust and moisture. Use a brush or air spray to clean dust, lint and other foreign particles from these connectors.
2. When the system is not being used, make sure the connections are protected to prevent dust and moisture from collecting inside. If the connectors are exposed, cover them with some sort of dust cap.

3. Cables are designed to be as tough as practical.
4. Careless and/or improper use of cables, such as making them carry loads that they are not designed for, can cause internal damage.
5. Connectors are weak points in any system. With the use of this product in rough, dusty and outdoor environments, users can minimize potential downtime if they care for cables and treat connectors with respect.
6. Cables and connectors are not designed to suspend or tow or otherwise carry the weight of systems. They are part of the electronic circuit and should be treated accordingly. When not in use they should be placed in their storage box.

12.3 Skid Pads

The bottom of the GPR Sensor is covered with a large, wear-resistant skid pad. The skid pad is designed to take the majority of the abrasive wear. If the pad wears down enough, the less-resistant plastic housing may start to wear. If this occurs, it is best to replace the skid pad. It is easily removed with a screwdriver and a new one can be purchased from the vendor.

12.4 Odometer

The odometer should be periodically calibrated (refer to Section 6.4) to ensure accuracy.

12.5 Storage Cases

Equipment that is transported and stored loosely is more susceptible to damage. All equipment should be stored in its shipping case or a storage box. Radiodetection has optional shipping cases available for all RD1100 systems.

12.6 Upgrading Embedded Software on Display Unit

From time to time, Radiodetection may release new software for the Display Unit. The instructions below describe how to update this software. Please note that this procedure will erase all GPR data from the system, so export any valuable data before continuing.

1. **Download** the zip file provided by Radiodetection
2. **Insert** a clean USB stick into your PC
3. **Unzip** the file by double clicking the file in Windows Explorer

4. **Copy** the unzipped folder to the root of the USB key. The resulting folder structure on the USB key should be:

dvl apps

 app1

 PACKAGE_NAME.en

 PACKAGE_NAME.pkg

Where PACKAGE_NAME is the name of the item to be installed.

5. **Turn off** the Display Unit. Remove the USB stick from your PC and insert it into the USB port on the side of the Display Unit
6. **Turn on** the Display Unit. You will see a list on the screen showing all software installations. The USB key may hold one or more packages which are displayed as numbered items:

Select app to run:

 1. PACKAGE_NAME

7. **Select** the package to run by pressing the associated numbered key on the Display Unit. The selected software will now be installed. The process may require multiple reboot cycles initiated by the system. When complete, the system will shut down and the red light on the front of the Display Unit will turn off.
8. **Remove** the USB stick from the Display Unit
9. **Turn on** the Display Unit and access the System Info screen (see Section 6) to verify the newly installed version number.

Section 13 - Technical Specifications

Specifications	Values
GPR Sensor size	630 x 410 x 230 mm (25 x 16 x 9 in)
GPR Sensor weight	5 kg (11 lbs)
Display Unit weight	2.83 kg (6.24 lbs)
Display Unit screen	8.0" high-visibility, sunlight-readable diagonal LCD display with touch screen Adjustable backlighting 1500 NIT and 800:1 contrast ratio
Battery weight	4 kg (8.8 lbs)
Wireless	Integrated modules: Wi-Fi (IEEE 802.11 b,g,n) GPS/GLONASS
Audio	Built-in speaker - 85dBA speaker w/volume control
Battery	Lead acid gel cell Battery Life: 4-6 hours Battery Capacity:9.0 Ah
Charger	Built-in charger with status indicator Universal AC mains charger input: 100-240V \sim , 1.5A, 50/60Hz Output: 12 Volts @ 3 Amps
DVL-500N Display Unit Input	11-18V \equiv , 4A maximum
Temperature & Environmental 	Ruggedized, environmentally sealed unit and connections. Ingress protection (IP) rating: DVL-500N Display Unit is rated to IP65 under IEC 60529 Relative Humidity operation (non-condensing): 10 – 90% GPR Sensor and DVL-500N operating temperature range: -40 to 50°C Do not use touch screen below -20°C. Use battery charger between 0 and 30°C.
Regulatory Specifications	EMC-FCC, CE, IC, ACA, RSM Safety-TUV, CE

Section 14 - Warranty

Subject to the conditions set out herein, Radiodetection Limited expressly and exclusively provides the following warranty to original end user buyers of Radiodetection products.

Radiodetection hereby warrants that its products shall be free from defects in material and workmanship for one year starting from point of sale to end customer. Extensions of this warranty period may be available where the same terms and conditions apply.

14.1 Statement of warranty conditions

The sole and exclusive warranty for any Radiodetection product found to be defective is repair or replacement of the defective product at Radiodetection's sole discretion. Repaired parts or replacement products will be provided by Radiodetection on an exchange basis and will be either new or refurbished to be functionally equivalent to new.

In the event this exclusive remedy is deemed to have failed of its essential purpose, Radiodetection's liability shall not exceed the purchase price of the Radiodetection product. In no event will Radiodetection be liable for any direct, indirect, special, incidental, consequential or punitive damages (including lost profit) whether based on warranty, contract, tort or any other legal theory.

Warranty services will be provided only with the original invoice or sales receipt (indicating the date of purchase, model name and dealer's name) within the warranty period. This warranty covers only the hardware components of the Radiodetection product.

Before a unit is submitted for service or repair, under the terms of this warranty or otherwise, any data stored on the unit should be backed-up to avoid any risk of data loss. Radiodetection will not be responsible for loss or erasure of data storage media or accessories.

Radiodetection is not responsible for transportation costs and risks associated with transportation of the product. The existence of a defect shall be determined by Radiodetection in accordance with procedures established by Radiodetection.

This warranty is in lieu of any other warranty, express or implied, including any implied warranty of merchantability or fitness for a particular purpose.

This warranty does not cover:

- a. Periodic maintenance and repair or parts replacement due to wear and tear.
- b. Consumables (components that are expected to require periodic replacement during the lifetime of a product such as non-rechargeable batteries, bulbs, etc.).
- c. Damage or defects caused by use, operation or treatment of the product inconsistent with its intended use.
- d. Damage or changes to the product as a result of:

- i. Misuse, including: - treatment resulting in physical, cosmetic or surface damage or changes to the product or damage to liquid crystal displays.
- ii. Failure to install or use the product for its normal purpose or in accordance with Radiodetection instructions on installation or use.
- iii. Failure to maintain the product in accordance with Radiodetection instructions on proper maintenance.
- iv. Installation or use of the product in a manner inconsistent with the technical or safety laws or standards in the country where it is installed or used.
- v. Virus infections or use of the product with software not provided with the product or incorrectly installed software.
- vi. The condition of or defects in systems with which the product is used or incorporated except other 'Radiodetection products' designed to be used with the product.
- vii. Use of the product with accessories, peripheral equipment and other products of a type, condition and standard other than prescribed by Radiodetection.
- viii. Repair or attempted repair by persons who are not Radiodetection warranted and certified repair houses.
- ix. Adjustments or adaptations without Radiodetection's prior written consent, including:
 - a. upgrading the product beyond specifications or features described in the instruction manual, or modifications to the product to conform it to national or local technical or safety standards in countries other than those for which the product was specifically designed and manufactured.
- x. Neglect e.g. opening of cases where there are no user-replaceable parts.
- xi. Accidents, fire, liquids, chemicals, other substances, flooding, vibrations, excessive heat, improper ventilation, power surges, excess or incorrect supply or input voltage, radiation, electrostatic discharges including lightning, other external forces and impacts.

Section 15 - Appendix A: Health & Safety Certification

Radio frequency electromagnetic fields may pose a health hazard when the fields are intense. Normal fields have been studied extensively over the past 30 years with no conclusive epidemiology relating electromagnetic fields to health problems. Detailed discussions on the subject are contained in the references and the web sites listed below.

The USA Federal Communication Commission (FCC) and Occupational Safety and Health Administration (OSHA) both specify acceptable levels for electromagnetic fields. Similar power levels are mandated by corresponding agencies in other countries. Maximum permissible exposures and time duration specified by the FCC and OSHA vary with excitation frequency. The lowest threshold plane wave equivalent power cited is $0.2\text{mW}/\text{cm}^2$ for the general population over the 30 to 300MHz frequency band. All other applications and frequencies have higher tolerances as shown graphically in Figure A-1.

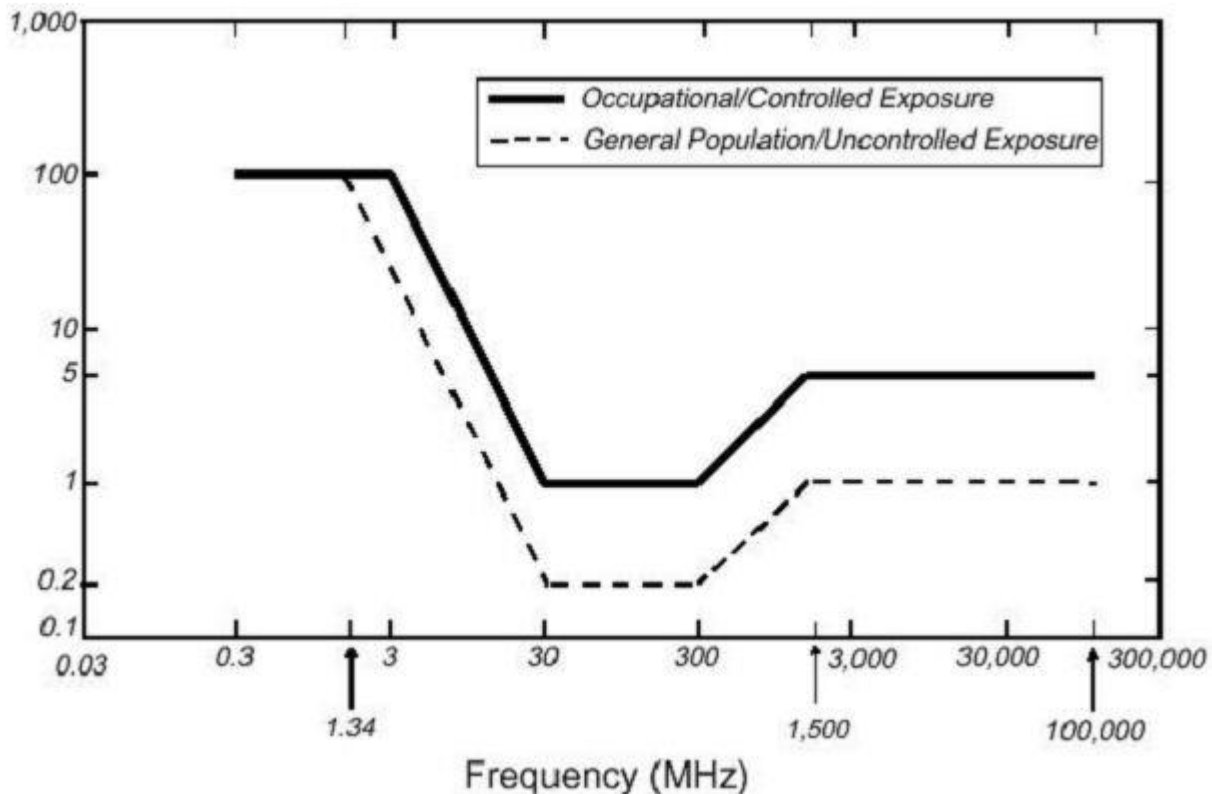

Figure A-1: FCC limits for maximum permissible exposure (MPE) plane-wave equivalent power density mW/cm^2 .

All Radiodetection Ltd GPR products are normally operated at least 1m (3') from the user and as such are classified as "mobile" devices according to the FCC. Typical power density levels at a distance of 1m or greater from any Radiodetection products are less than $10^{-3}\text{mW}/\text{cm}^2$ which

is 200 to 10,000 times lower than mandated limits. As such, Radiodetection products pose no health and safety risk when operated in the normal manner of intended use.

Section 16 - Appendix B: GPR Emissions, Interference and Regulations

Most governments have regulations on the level of electromagnetic emissions that an electronic apparatus can emit. The objective is to ensure that one apparatus or device does not interfere with any other apparatus or device in such a way as to make the other apparatus non-functional.

The manufacturer tests their GPR products using professional, independent testing houses and complies with the regulations of the USA, Canada, European Community and other major jurisdictions on the matter of emissions.

Electronic devices have not always been designed for proper immunity. If a GPR instrument is placed in close proximity to an electronic device, interference may occur. While there have been no substantiated reports of interference to date, if any unusual behavior is observed on nearby devices, test if the disturbance starts and stops when the GPR instrument is turned on and off. If interference is confirmed, stop using the GPR.

Where specific jurisdictions have specific GPR guidelines, you must comply with them. Some of these are described below.

B-1 FCC Regulations

This device complies with Part 15 of the USA Federal Communications Commission (FCC) Rules. Operation in the USA is subject to the following two conditions:

 this device may not cause harmful interference and

 this device must accept any interference received, including interference that may cause undesired operation.

Part 15 – User Information

This equipment has been tested and found to comply with the limits for a Class A digital device, where applicable, and for an ultra-wide bandwidth (UWB) device where applicable, pursuant to Part 15 of the FCC Rules. These limits are designed to provide reasonable protection against harmful interference when the equipment is operated in a commercial environment. This equipment uses and can radiate radio frequency energy and, if not installed and used in accordance with the instruction manual, may cause harmful interference to radio communications. Operation of this equipment in a residential area is likely to cause harmful interference in which case the user will be required to correct the interference at his/her own expense.

WARNING

Changes or Modifications not expressly approved by the manufacturer could void the user's authority to operate the equipment.

Certification of this equipment has been carried out using approved cables and peripheral devices. The use of non-approved or modified cables and peripheral devices constitutes a Change or Modification outlined in the warning above.

Operating Restrictions

Operation of this device is limited to purposes associated with law enforcement, firefighting, emergency rescue, scientific research, commercial mining, or construction. Parties operating this equipment must be eligible for licensing under the provisions of Part 90 of this chapter.

FCC Interpretation of Operation Restrictions issued July 12, 2002

(FCC Order DA02-1658, paragraph 9)

The regulations contain restrictions on the parties that are eligible to operate imaging systems (See 47 C.F.R. 5.509(b), 15.511(b), and 15.513(b)). Under the new regulations, GPRs and wall imaging systems may be used only by law enforcement, fire and emergency rescue organizations, by scientific research institutes, by commercial mining companies, and by construction companies. Since the adoption of the *Order*, we have received several inquiries from the operators of GPRs and wall imaging systems noting that these devices often are not operated by the users listed in the regulations but are operated under contract by personnel specifically trained in the operation of these devices. We do not believe that the recent adoption of the UWB rules should disrupt the critical safety services that can be performed effectively only through the use of GPRs and wall imaging systems. We viewed these operating restrictions in the broadest of terms. For example, we believe that the limitation on the use of GPRs and wall imaging systems by construction companies encompasses the inspection of buildings, roadways, bridges and runways even if the inspection finds no damage to the structure and construction does not actually result from the inspection; the intended purpose of the operation of the UWB device is to determine if construction is required. We also believe that the GPRs and wall imaging systems may be operated for one of the purposes described in the regulations but need not be operated directly by one of the described parties. For example, a GPR may be operated by a private company investigating forensic evidence for a local police department.

FCC Permitted Mode of Usage

The GPR antenna must be kept on the surface to be in compliance with FCC regulations. Use of the antenna is not permitted if it is lifted off the surface. Use as a through-the-wall imaging device is prohibited.

GPR Use Coordination

FCC regulation 15.525(c) (updated in February 2007) requires users of GPR equipment to coordinate the use of their GPR equipment as described below:

TITLE 47--TELECOMMUNICATION

CHAPTER I--FEDERAL COMMUNICATIONS COMMISSION

PART 15_RADIO FREQUENCY DEVICES

Subpart F_Ultra-Wideband Operation Sec.

15.525 Coordination requirements.

(a) UWB imaging systems require coordination through the FCC before the equipment may be used. The operator shall comply with any constraints on equipment usage resulting from this coordination.

(b) The users of UWB imaging devices shall supply operational areas to the FCC Office of Engineering and Technology, which shall coordinate this information with the Federal Government through the National Telecommunications and Information Administration. The information provided by the UWB operator shall include the name, address and other pertinent contact information of the user, the desired geographical area(s) of operation, and the FCC ID number and other nomenclature of the UWB device. If the imaging device is intended to be used for mobile applications, the geographical area(s) of operation may be the state(s) or county(ies) in which the equipment will be operated. The operator of an imaging system used for fixed operation shall supply a specific geographical location or the address at which the equipment will be operated. This material shall be submitted to:

Frequency Coordination Branch, OET
Federal Communications Commission
445 12th Street, SW, Washington, D.C.
20554

Attn: UWB Coordination

(Manufacturer's note: The form given on the following page is a suggested format for performing the coordination.)

(c) The manufacturers, or their authorized sales agents, must inform purchasers and users of their systems of the requirement to undertake detailed coordination of operational areas with the FCC prior to the equipment being operated.

(d) Users of authorized, coordinated UWB systems may transfer them to other qualified users and to different locations upon coordination of change of ownership or location to the FCC and coordination with existing authorized operations.

(e) The FCC/NTIA coordination report shall identify those geographical areas within which the operation of an imaging system requires additional coordination or within which the operation of an imaging system is prohibited. If additional coordination is required for operation within specific geographical areas, a local coordination contact will be provided. Except for operation within these designated areas, once the information requested on the UWB imaging system is submitted to the FCC no additional coordination with the FCC is required provided the reported areas of operation do not change. If the area of operation changes, updated information shall be submitted to the FCC following the procedure in paragraph (b) of this section.

(f) The coordination of routine UWB operations shall not take longer than 15 business days from the receipt of the coordination request by NTIA. Special temporary operations may be handled with an expedited turn-around time when circumstances warrant. The operation of UWB systems in emergency situations involving the safety of life or property may occur without coordination provided a notification procedure, similar to that contained in Sec. 2.405(a) through

(e) of this chapter, is followed by the UWB equipment user.[67 FR 34856, May 16, 2002, as amended at 68 FR 19751, Apr. 22, 2003]

Effective Date Note: At 68 FR 19751, Apr. 22, 2003, Sec. 15.525 was amended by revising [[Page 925]] paragraphs (b) and (e). This amendment contains information collection and recordkeeping requirements and will not become effective until approval has been given by the Office of Management and Budget.

FCC GROUND PENETRATING RADAR COORDINATION NOTICE

NAME:

ADDRESS:

CONTACT INFORMATION [CONTACT NAME AND PHONE NUMBER]:

AREA OF OPERATION [COUNTIES, STATES OR LARGER AREAS]:

FCC ID: QJQ-NG250

EQUIPMENT NOMENCLATURE: NG250

Send the information to:

Frequency Coordination Branch, OET

Federal Communications Commission

445 12th Street, SW

Washington, D.C. 20554

ATTN: UWB Coordination

Fax: 202-418-1944

INFORMATION PROVIDED IS DEEMED CONFIDENTIAL

B-2 ETSI Regulations for the EC (European Community)

In the European Community (EC), GPR instruments must conform to ETSI (European Technical Standards Institute) standard EN 302 066-1 v1.2.1. Details on individual country requirements for licensing are coordinated with this standard. For more information, contact Radiodetection's technical support staff.

All Radiodetection ground penetrating radar (GPR) products offered for sale in European Community countries, or countries adhering to ETSI standards, are tested to comply with EN 302 066 v1.2.1.

It is the user's responsibility to check and ensure that they satisfy individual country licensing requirements.

The UK for example, does currently require a licence to operate Ground Penetrating Radar, details are available from OFCOM. (<https://licensing.ofcom.org.uk>).

We recommend that users check with the Radio and Telecoms Licensing authority in the country of use. Radiodetection sales and support staff can help with contact details and information.

For those who wish to get more detailed information, they should acquire copies of the following documents available from ETSI.

ETSI EN 302 066-1 V1.2.1 (February 2008) Electromagnetic compatibility and Radio spectrum Matters (ERM); Ground and Wall- Probing Radar applications (GPR/WPR) imaging systems; Part 1: Technical characteristics and test methods

ETSI EN 302 066-2 V1.2.1 (February 2008) Electromagnetic compatibility and Radio spectrum Matters (ERM); Ground and Wall- Probing Radar applications (GPR/WPR) imaging systems; Part 2: Harmonized EN covering essential requirements of article 3.2 of the R&TTE Directive

ETSI TR 101 994-2 V1.1.2 (March 2008) Electromagnetic compatibility and Radio spectrum Matters (ERM); Short Range Devices (SRD); Technical characteristics for SRD equipment using Ultra Wide Band technology (UWB); Part 2: Ground- and Wall- Probing Radar applications; System Reference Document

B-3a Industry Canada Regulations - English

Industry Canada published its regulations for ground penetrating radar (GPR) on Mar 29 2009 as part of the RSS-220 titled 'Devices Using Ultra-Wideband (UWB) Technology'.

Industry Canada has made a unique exception for GPR by not requiring user licensing. The user does have to comply with the following directives:

This Ground Penetrating Radar Device shall be operated only when in contact with or within 1m of the ground.

This Ground Penetrating Radar Device shall be operated only by law enforcement agencies, scientific research institutes, commercial mining companies, construction companies, and emergency rescue or firefighting organizations.

Should the ground penetrating radar be used in a wall-penetrating mode then the following restriction should be noted by the user:

This In-wall Radar Imaging Device shall be operated where the device is directed at the wall and in contact with or within 20 cm of the wall surface.

This In-wall Radar Imaging Device shall be operated only by law enforcement agencies, scientific research institutes, commercial mining companies, construction companies, and emergency rescue or firefighting organizations.

Since operation of GPR is on a license-exempt basis, the user must accept the following:

Operation is subject to the following two conditions: (1) this device may not cause interference, and (2) this device must accept any interference, including interference that may cause undesired operation of the device.

B-3b Règlement d'Industrie Canada - Français

Industrie Canada a publié des règlements pour les appareils géoradar (GPR) le 29 mars 2009, dans le cadre du RSS-220 intitulé "Dispositifs utilisant la bande ultra-large (UWB)".

Industrie Canada a faite une exception unique pour GPR en n'exigeant pas de licence par utilisateur. L'utilisateur doit se conformer aux directives suivantes:

Ce géoradar périphérique doit être utilisé que lorsqu'il est en contact avec ou moins de 1 m du sol.

Ce géoradar périphérique doit être utilisé que par les organisations d'application de la loi, les instituts de recherche scientifique, des sociétés minières commerciales, entreprises de construction et de secours d'urgence ou des organisations de lutte contre les incendies.

Si le géoradar est utilisé dans un mode de pénétration au mur, la restriction suivante est à noter par l'utilisateur:

Ce dispositif d'imagerie radar doit être utilisé lorsque l'appareil est orienté vers le mur et en contact avec ou dans les 20 cm de la surface du mur.

Ce dispositif d'imagerie radar doit être utilisé que par les organisations d'application de la loi, les instituts de recherche scientifique, des sociétés minières commerciales, entreprises de construction et de secours d'urgence ou des organisations de lutte contre les incendies.

Parce que l'exploitation de GPR est sur une base exempte de licence, l'utilisateur doit accepter le texte suivant:

La fonctionnement est soumis aux deux conditions suivantes: (1) cet appareil ne peut pas provoquer d'interférences et (2) cet appareil doit accepter toute interférence, y compris les interférences qui peuvent causer un mauvais fonctionnement du dispositif

Section 17 - Appendix C: Instrument Interference

Immunity regulations place the onus on instrument/apparatus/device manufacturers to ensure that extraneous interference will not unduly cause an instrument/apparatus/device to stop functioning or to function in a faulty manner.

Based on independent testing house measurements, Radiodetection systems comply with such regulations in Canada, USA, European Community and most other jurisdictions. GPR devices can sense electromagnetic fields. External sources of electromagnetic fields such as TV stations, radio stations and cell phones, can cause signals detectable by a GPR which may degrade the quality of the data that a GPR device records and displays.

Such interference is unavoidable but sensible survey practice and operation by an experienced GPR practitioner can minimize such problems. In some geographic areas emissions from external sources may be so large as to preclude useful measurements. Such conditions are readily recognized and accepted by the professional geophysical community as a fundamental limitation of geophysical survey practice. Such interference being present in the GPR recordings is not considered as an equipment fault or as a failure to comply with immunity regulations.

Section 18 - Appendix D: Safety around Explosive Devices

Concerns are expressed from time to time on the hazard of GPR products being used near blasting caps and unexploded ordnance (UXO). Experience with blasting caps indicates that the power of Radiodetection's GPR products is not sufficient to trigger blasting caps. Based on a conservative independent testing house analysis, we recommend keeping the GPR transmitters at least 6 feet (2m) from blasting cap leads as a precaution. Some customers do experimental trials with their particular blasting devices to confirm safety.

We strongly recommend that GPR users routinely working with explosive devices develop a systematic safety methodology in their work areas.

The UXO issue is more complex and standards on fuses do not exist for obvious reasons. To date, no problems have been reported with any geophysical instrument used for UXO. Since proximity and vibration are also critical for UXO, the best advice is to be cautious and understand the risks.

Section 19 - Appendix E: WiFi Module

FCC Notice:

NOTE: This equipment has been tested and found to comply with the limits for a Class A digital device, pursuant to part 15 of the FCC Rules. These limits are designed to provide reasonable protection against harmful interference when the equipment is operated in a commercial environment. This equipment generates, uses, and can radiate radio frequency energy and, if not installed and used in accordance with the instruction manual, may cause harmful interference to radio communications. Operation of this equipment in a residential area is likely to cause harmful interference in which case the user will be required to correct the interference at his/her own expense.

Industry Canada Notice:

This device complies with Industry Canada's license-exempt RSSs. Operation is subject to the following two conditions:

- (1) This device may not cause interference; and
- (2) This device must accept any interference, including interference that may cause undesired operation of the device.

Section 20 - Appendix F – Import/Export

Dual Use

The definition of 'dual use items' is given as:

'Dual-use items' shall mean items, including software and technology, which can be used for both civil and military purposes, and shall include all goods which can be used for both non-explosive uses and assisting in any way in the manufacture of nuclear weapons or other nuclear explosive devices.

The manufacturer warrants that the RD1100 is not dual-use.

Global locations

Radiodetection (USA)

28 Tower Road, Raymond, Maine 04071, USA

Tel: +1 (207) 655 8525 Toll Free: +1 (877) 247 3797 rd.sales.us@spx.com www.radiodetection.com

Pearpoint (USA)

39-740 Garand Lane, Unit B, Palm Desert, CA 92211, USA

Tel: +1 800 688 8094 Tel: +1 760 343 7350 pearpoint.sales.us@spx.com www.radiodetection.com

Radiodetection (Canada)

344 Edgeley Boulevard, Unit 34, Concord, Ontario L4K 4B7, Canada

Tel: +1 (905) 660 9995 Toll Free: +1 (800) 665 7953 rd.sales.ca@spx.com www.radiodetection.com

Radiodetection Ltd. (UK)

Western Drive, Bristol, BS14 0AF, UK

Tel: +44 (0) 117 976 7776 rd.sales.uk@spx.com www.radiodetection.com

Radiodetection (France)

13 Grande Rue, 76220, Neuf Marché, France

Tel: +33 (0) 2 32 89 93 60 rd.sales.fr@spx.com <http://fr.radiodetection.com>

Radiodetection (Benelux)

Industriestraat 11, 7041 GD 's-Heerenberg, Netherlands

Tel: +31 (0) 314 66 47 00 rd.sales.nl@spx.com <http://nl.radiodetection.com>

Radiodetection (Germany)

Groendahlscher Weg 118, 46446 Emmerich am Rhein, Germany

Tel: +49 (0) 28 51 92 37 20 rd.sales.de@spx.com <http://de.radiodetection.com>

Radiodetection (Asia-Pacific)

Room 708, CC Wu Building, 302-308 Hennessy Road, Wan Chai, Hong Kong SAR, China

Tel: +852 2110 8160 rd.sales.asiapacific@spx.com www.radiodetection.com

Radiodetection (China)

Room 5-10, Workshop 4, No. 10 Zhenggezhuang Village, Beiqijia Town, Changping District, Beijing 102209, China

Tel: +86 (0) 10 8178 5652 rd.service.cn@spx.com <http://cn.radiodetection.com>

Radiodetection (Australia)

Unit H1, 101 Rookwood Road, Yagoona NSW 2199, Australia

Tel: +61 (0) 2 9707 3222 rd.sales.au@spx.com www.radiodetection.com