

# Leica Rod Eye 160 User Manual



Version 1.0  
English

- when it has to be **right**

**Leica**  
Geosystems

# Introduction

---

## Purchase

Congratulations on the purchase of a Leica Rod Eye 160.

---



Read and follow the User Manual on the accompanying DVD before using the product.

- This Quick Start Guide contains first use directions as well as initial, basic instructions for setting up the product and operating it.
  - Keep all documentation for future reference!
- 

## Available documentation

**Refer to the following resources for all Rod Eye 160 documentation/software:**

- the Leica Rugby CD
  - <https://myworld.leica-geosystems.com>
-

# Table of Contents

In this manual	Chapter	Page
	<b>1 Safety Directions</b>	<b>4</b>
	1.1 General	4
	1.2 Definition of Use	5
	1.3 Limits of Use	5
	1.4 Responsibilities	5
	1.5 Electromagnetic Compatibility EMC	5
	1.6 FCC Statement, Applicable in U.S.	6
	<b>2 Instrument Components</b>	<b>8</b>
	<b>3 Operation</b>	<b>11</b>
	<b>4 Technical Data</b>	<b>13</b>
	<b>5 Care and Transport</b>	<b>14</b>
	5.1 Transport	14
	5.2 Storage	14

# 1 Safety Directions

## 1.1 General

### Description

The following directions enable the person responsible for the product, and the person who actually uses the equipment, to anticipate and avoid operational hazards.

The person responsible for the product must ensure that all users understand these directions and adhere to them.

### About Warning Messages





Warning messages are an essential part of the safety concept of the instrument. They appear wherever hazards or hazardous situations can occur.

#### Warning messages...

- make the user alert about direct and indirect hazards concerning the use of the product.
- contain general rules of behaviour.

For the users' safety, all safety instructions and safety messages shall be strictly observed and followed! Therefore, the manual must always be available to all persons performing any tasks described herein.

**DANGER, WARNING, CAUTION** and **Notice** are standardized signal words for identifying levels of hazards and risks related to personal injury and property damage. For your safety it is important to read and fully understand the table below with the different signal words and their definitions! Supplementary safety information symbols may be placed within a warning message as well as supplementary text.

Type	Description
 <b>DANGER</b>	Indicates an imminently hazardous situation which, if not avoided, will result in death or serious injury.
 <b>WARNING</b>	Indicates a potentially hazardous situation or an unintended use which, if not avoided, could result in death or serious injury.
 <b>CAUTION</b>	Indicates a potentially hazardous situation or an unintended use which, if not avoided, may result in minor or moderate injury.
<b>NOTICE</b>	Indicates a potentially hazardous situation or an unintended use which, if not avoided, may result in appreciable material, financial and environmental damage.
	Important paragraphs which must be adhered to in practice as they enable the product to be used in a technically correct and efficient manner.

## 1.2 Definition of Use

---

**Intended use**

- Remote control of product.
- Data communication with external appliances.

---

**Reasonably foreseeable misuse**

- Use of the product without instruction.
- Use outside of the intended use and limits.
- Opening the product using tools, for example screwdriver, unless this is permitted for certain functions.
- Modification or conversion of the product.

---



### WARNING

Adverse use can lead to injury, malfunction and damage.

It is the task of the person responsible for the equipment to inform the user about hazards and how to counteract them. The product is not to be operated until the user has been instructed on how to work with it.

---

## 1.3 Limits of Use

---

**Environment**

Suitable for use in an atmosphere appropriate for permanent human habitation: not suitable for use in aggressive or explosive environments.

---



### DANGER

Local safety authorities and safety experts must be contacted before working in hazardous areas, or close to electrical installations or similar situations by the person in charge of the product.

---

## 1.4 Responsibilities

---

**Manufacturer of the product**

Leica Geosystems AG, CH-9435 Heerbrugg, hereinafter referred to as Leica Geosystems, is responsible for supplying the product, including the user manual and original accessories, in a safe condition.

---

**Person responsible for the product**

The person responsible for the product has the following duties:

- To understand the safety instructions on the product and the instructions in the user manual.
- To ensure that it is used in accordance with the instructions.
- To be familiar with local regulations relating to safety and accident prevention.
- To inform Leica Geosystems immediately if the product and the application becomes unsafe.
- To ensure that the national laws, regulations and conditions for the operation of e.g. radio transmitters, lasers are respected.

---

## 1.5 Electromagnetic Compatibility EMC

---

**Description**

The term Electromagnetic Compatibility is taken to mean the capability of the product to function smoothly in an environment where electromagnetic radiation and electrostatic discharges are present, and without causing electromagnetic disturbances to other equipment.

---



### WARNING

Electromagnetic radiation can cause disturbances in other equipment.

Although the product meets the strict regulations and standards which are in force in this respect, Leica Geosystems cannot completely exclude the possibility that other equipment may be disturbed.

---

**CAUTION**

There is a risk that disturbances may be caused in other equipment if the product is used with accessories from other manufacturers, for example field computers, personal computers or other electronic equipment, non-standard cables or external batteries.

**Precautions:**

Use only the equipment and accessories recommended by Leica Geosystems. When combined with the product, they meet the strict requirements stipulated by the guidelines and standards. When using computers or other electronic equipment, pay attention to the information about electromagnetic compatibility provided by the manufacturer.

**CAUTION**

Disturbances caused by electromagnetic radiation can result in erroneous measurements.

Although the product meets the strict regulations and standards which are in force in this respect, Leica Geosystems cannot completely exclude the possibility that the product may be disturbed by intense electromagnetic radiation, for example, near radio transmitters, two-way radios or diesel generators.

**Precautions:**

Check the plausibility of results obtained under these conditions.

**CAUTION**

If the product is operated with connecting cables attached at only one of their two ends, for example external supply cables, interface cables, the permitted level of electromagnetic radiation may be exceeded and the correct functioning of other products may be impaired.

**Precautions:**

While the product is in use, connecting cables, for example product to external battery, product to computer, must be connected at both ends.

**1.6****FCC Statement, Applicable in U.S.**

The greyed paragraph below is only applicable for products without radio.

**WARNING**

This equipment has been tested and found to comply with the limits for a Class B digital device, pursuant to part 15 of the FCC rules.

These limits are designed to provide reasonable protection against harmful interference in a residential installation.

This equipment generates, uses and can radiate radio frequency energy and, if not installed and used in accordance with the instructions, may cause harmful interference to radio communications. However, there is no guarantee that interference will not occur in a particular installation.

If this equipment does cause harmful interference to radio or television reception, which can be determined by turning the equipment off and on, the user is encouraged to try to correct the interference by one or more of the following measures:

- Reorient or relocate the receiving antenna.
- Increase the separation between the equipment and the receiver.
- Connect the equipment into an outlet on a circuit different from that to which the receiver is connected.
- Consult the dealer or an experienced radio/TV technician for help.

**WARNING**

Changes or modifications not expressly approved by Leica Geosystems for compliance could void the user's authority to operate the equipment.



## Labelling Rod Eye

Rod Eye 160:





004661\_001

**Type: RE160**  
Power : 3V $\approx$  / 60mA  
Art.No.: 78549Z  
Made in China

**Swiss Technology**  
by **Leica Geosystems**  
CH-9435 Heerbrugg

  

This device complies with part 15 of the FCC Rules. Operation is subject to the following two conditions:  
(1) This device may not cause harmful interference, and  
(2) this device must accept any interference received, including interference that may cause undesired operation.

## 2

## Instrument Components

### Instrument components part 1 of 2

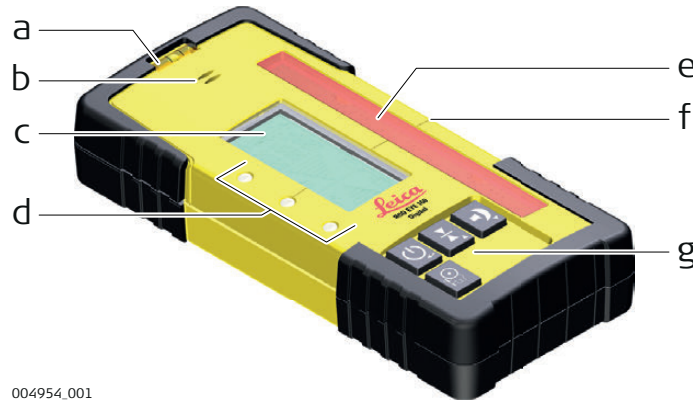

004954\_001

- a) Level vial
- b) Audio Speaker
- c) LCD window
- d) LEDs
- e) Laser Reception window
- f) On-grade
- g) Keypad

Component	Description
Level vial	Aids to keep the rod plumb when taking readings.
Audio Speaker	Indicates the detector's position: <ul style="list-style-type: none"> <li>• High - Fast beeping</li> <li>• On-grade - Solid tone</li> <li>• Low - Slow beeping</li> </ul>
LCD window	Front and rear LCD arrow indicate the detector's position.
LEDs	Display the relative position of the laser beam. Five channel indication: <ul style="list-style-type: none"> <li>• High - Red</li> <li>• On-grade - Green</li> <li>• Low - Blue</li> </ul>
Laser Reception window	Detects the laser beam. The reception windows must be directed towards the laser.
On-grade	Indicates the on-grade position of the laser.
Keypad	Power, accuracy, volume and capture functions. Refer to "Description of the Buttons" for detailed information.



**Instrument components  
part 2 of 2**

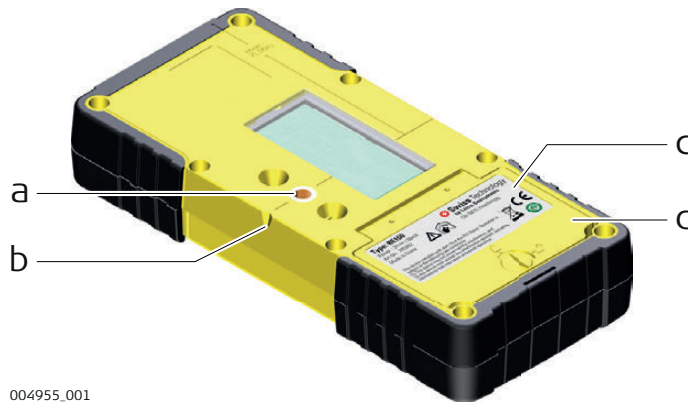

004955.001

- a) Bracket Mounting Hole
- b) Offset notch
- c) Product label
- d) Battery door

Component	Description
Bracket Mounting Hole	Location to attach the receiver bracket for normal operation.
Offset notch	Use to transfer reference marks. The notch is 85 mm (3.35") below to top of the detector.
Product label	The serial number is located inside the battery compartment.
Battery door	Refer to "Changing the alkaline batteries step-by-step" for detailed information.

**Description of the Buttons**



004956.001

- a) Power
- b) Laser man
- c) Audio
- d) Bandwidth

Button	Function
Power	Press once to turn on the Receiver.
Laser man	Press to capture digital reading.
Audio	Press to change the audio output.
Bandwidth	Press to change detection bandwidth.

## Detector bracket

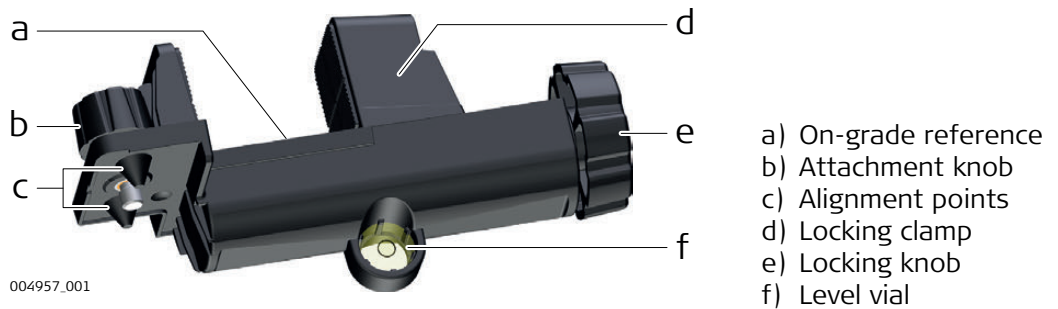

Component	Description
On-grade reference	The top edge of the bar aligns with the on-grade position.
Attachment knob	Attaches the clamp to the back of the detector.
Alignment points	Aligns and secures the clamp.
Locking clamp	Holds the receiver and bracket to the grade rod.
Locking knob	Turn to tighten the locking clamp to the grade rod.
Level vial	The aids to keep the rod plumb when taking readings.

## Special features





Feature	Description
Strobe rejection	The RE Digital is designed to reject and eliminate unwanted signals from strobe lights.
Beam finding	Passing the RE Digital through the laser beam will cause the sensor to beep twice quickly.
Out of beam display	If the detector is moved out of the detector range, the arrow display will indicate the direction to move to return to the laser beam.
Laser low battery	Alerts the user when the lasers's batteries are getting low.

**Menu access and navigation**

To access the menu of the Rod Eye 160 Digital Receiver, press the Bandwidth button and Audio button simultaneously.

- Use the Bandwidth button and Audio button to change parameters.
- Use the Power button to scroll through the menu.

**Menu**

Menu	Function	Indication
UNT	Changes the unit of measure for the digital readout.	Units - mm/cm/in/ft  Active unit flashes.
LED	Changes the brightness of the LED indicators.	LEDs - High/Low/Off
DRO	Turns on or off the digital readout.	Green LED is on: digital readout is on.
		Red LED is on: digital readout is off.  DRO flashes.
BAT	Turns on or off the Laser low battery indication on the receiver.	Green LED is on: Laser low battery icon function is active.
		Red LED is on: Laser low battery icon function is not active.  Rugby icon flashes.
MEM	Turns on or off the position memory function.	Green LED is on: function is on.
		Red LED is on: function is off.  Full down arrow flashes.
RPS	Measures the head speed of the laser.  Hold in rotating beam to measure the head speed.	Measured head speed is displayed.

## Changing the alkaline batteries step-by-step

The small battery icon will appear empty on the Rod Eye 160 display when the batteries are low and need to be replaced.

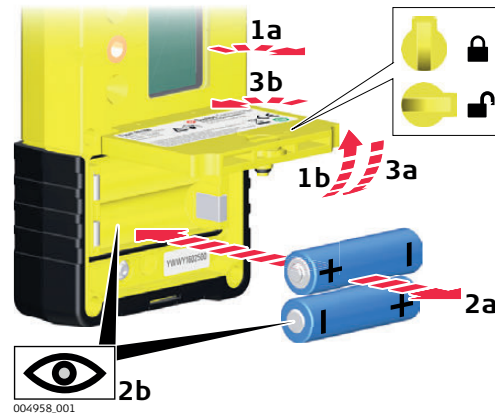

Step	Description
	The batteries are inserted under the battery door.
1.	Turn the locking mechanism to the open position to open the battery door.
2.	Remove the batteries from the battery compartment. To insert the batteries: Insert the batteries into the battery compartment, ensuring that the contacts are facing in the right direction. The correct polarity is displayed inside the battery compartment.
3.	Close the cover of the battery compartment and turn the locking mechanism to the closed position to lock the battery door.

## LCD Display

Icon	Description
	<b>Grade indication arrow</b> - Seven channels are displayed for above and below grade. <ul style="list-style-type: none"> <li>Arrow bars can be selected to represent the selected accuracy bandwidth.</li> <li>Memory Display - if the receiver is moved out of the detection range, the arrow display indicates the direction to move to return to the laser beam (see MEM in menu to enable/disable).</li> </ul>
	<b>Laser low battery warning</b> - The laser icon is displayed when the battery of the laser unit is almost depleted. This feature is laser dependent (see BAT in menu to enable/disable).
	<b>Audio volume indication</b> - Four levels of volume are displayed: loud, medium, soft, off (no icon).
mm cm in ft	<b>Units of measure</b> - Five units of measure are displayed: mm (millimeter), cm (centimeters), in (inch), in (fractions), ft (feet).
	<b>Elevation indication</b> - Numeric value is displayed (dependent on the unit of measure chosen).
	<b>Accuracy indication</b> - Five levels of accuracy are displayed: ultra fine, super fine, fine, medium, coarse.
	<b>Receiver low battery warning</b> - Three levels of battery life are displayed: full, low, empty.

**Conformity to national regulations**

- FCC Part 15 (applicable in US)
- Hereby, Leica Geosystems AG, declares that the product Rod Eye 160 is in compliance with the essential requirements and other relevant provisions of Directive 1999/5/EC and other applicable European Directives. The declaration of conformity may be consulted at <http://www.leica-geosystems.com/ce>.



Class 1 equipment according European Directive 1999/5/EC (R&TTE) can be placed on the market and be put into service without restrictions in any EU Member state.

- The conformity for countries with other national regulations not covered by the FCC part 15 or European directive 1999/5/EC has to be approved prior to use and operation.

**Technical data**

Working diameter (laser dependent):	1350 m/4430 ft
Detection height:	120 mm/5 in
Numeric readout height:	90 mm/3.5 in
Detectable spectrum:	600 nm to 800 nm
Detectable accuracies	
Very fine:	± 0.5 mm/± 0.02 in
Fine:	± 1.0 mm/± 0.04 in
Medium:	± 2.0 mm/± 0.08 in
Coarse:	± 3.0 mm/± 0.12 in
Very coarse:	± 5.0 mm/± 0.20 in
Audio volumes:	105 dBA/95 dBA/65dBA/Off
Automatic shut off:	10 minutes
Digital readout - units:	mm, cm, in, in (fractions), ft
Arrow display - channels:	15 channels
Anti-strobe protection:	Yes
Memory, last beam strike:	Yes
Beam finding (double beep):	Yes
Laser low battery indicator:	Yes
Warranty:	3 years
Environmental:	IP67
Batteries:	2 x 1.5 V "AA" - 50+ hours
Dimensions:	173 x 76 x 29 mm/6.8 x 3.0 x 1.1 in
Operating temperature:	-20°C to +50°C/-4°F to +122°F
Storage temperature (except batteries):	-40°C to +70°C/-40°F to +158°F

## 5 Care and Transport

### 5.1 Transport

---

<b>Transport in the field</b>	When transporting the equipment in the field, always make sure that you <ul style="list-style-type: none"><li>• either carry the product in its original transport container,</li><li>• or carry the tripod with its legs splayed across your shoulder, keeping the attached product upright.</li></ul>
<b>Transport in a road vehicle</b>	Never carry the product loose in a road vehicle, as it can be affected by shock and vibration. Always carry the product in its transport container and secure it.
<b>Shipping</b>	When transporting the product by rail, air or sea, always use the complete original Leica Geosystems packaging, transport container and cardboard box, or its equivalent, to protect against shock and vibration.
<b>Shipping, transport of batteries</b>	When transporting or shipping batteries, the person in charge of the product must ensure that the applicable national and international rules and regulations are observed. Before transportation or shipping, contact your local passenger or freight transport company.
<b>Field adjustment</b>	Periodically carry out test measurements and perform the field adjustments indicated in the User Manual, particularly after the product has been dropped, stored for long periods or transported.

---

### 5.2 Storage

---

<b>Product</b>	Respect the temperature limits when storing the equipment, particularly in summer if the equipment is inside a vehicle. Refer to "4 Technical Data" for information about temperature limits.
<b>Li-Ion and alkaline batteries</b>	<b>For Li-Ion and alkaline batteries</b> <ul style="list-style-type: none"><li>• Refer to "4 Technical Data" for information about storage temperature range.</li><li>• Remove batteries from the product and the charger before storing.</li><li>• After storage recharge batteries before using.</li><li>• Protect batteries from damp and wetness. Wet or damp batteries must be dried before storing or use.</li></ul> <b>For Li-Ion batteries</b> <ul style="list-style-type: none"><li>• A storage temperature range of -20°C to +30°C/-4°F to 86°F in a dry environment is recommended to minimise self-discharging of the battery.</li><li>• At the recommended storage temperature range, batteries containing a 50% to 100% charge can be stored for up to one year. After this storage period the batteries must be recharged.</li></ul>

---



**Total Quality Management: Our commitment to total customer satisfaction.**



Leica Geosystems AG, Heerbrugg, Switzerland, has been certified as being equipped with a quality system which meets the International Standards of Quality Management and Quality Systems (ISO standard 9001) and Environmental Management Systems (ISO standard 14001).

**Ask your local Leica Geosystems dealer/sales representative for more information about our TQM program.**

**804476-1.0.0en**

Original text

Published in Switzerland

© 2013 Leica Geosystems AG, Heerbrugg, Switzerland

**Leica Geosystems AG**  
Heinrich-Wild-Strasse  
CH-9435 Heerbrugg  
Switzerland  
Phone +41 71 727 31 31  
[www.leica-geosystems.com](http://www.leica-geosystems.com)

- when it has to be **right**

**Leica**  
Geosystems