

Leica FlexLine plus

User Manual



Version 1.0
English

- when it has to be **right**

Leica
Geosystems

Introduction

Purchase

Congratulations on the purchase of a FlexLine plus instrument.



This manual contains important safety directions as well as instructions for setting up the product and operating it. Refer to "13 Safety Directions" for further information. Read carefully through the User Manual before you switch on the product.

Product identification

The model and serial number of your product are indicated on the type plate. Enter the model and serial number in your manual and always refer to this information when you need to contact your agency or Leica Geosystems authorised service workshop.

Model: _____

Serial No.: _____

Symbols

The symbols used in this manual have the following meanings:

Type	Description
DANGER	Indicates an imminently hazardous situation which, if not avoided, will result in death or serious injury.
WARNING	Indicates a potentially hazardous situation or an unintended use which, if not avoided, could result in death or serious injury.
CAUTION	Indicates a potentially hazardous situation or an unintended use which, if not avoided, may result in minor or moderate injury.
NOTICE	Indicates a potentially hazardous situation or an unintended use which, if not avoided, may result in appreciable material, financial and environmental damage.
	Important paragraphs which must be adhered to in practice as they enable the product to be used in a technically correct and efficient manner.

Trademarks

- Windows is a registered trademark of Microsoft Corporation.
 - Bluetooth is a registered trademark of Bluetooth SIG, Inc.
- All other trademarks are the property of their respective owners.

Validity of this manual

	Description
General	This manual applies to TS06 plus and TS09 plus instruments. Where there are differences between the various instruments they are clearly described.
Telescope	<ul style="list-style-type: none">• Measuring with Prism mode: When measuring distances to a reflector with Electronic Distance Measurement (EDM) mode "Prism", the telescope uses a wide visible red laser beam, which emerges coaxially from the telescope's objective.• Measuring with Non-Prism modes: Instruments that are equipped with a reflectorless EDM additionally offer the EDM mode "Non-Prism". When measuring distances with this EDM mode, the telescope uses a narrow visible red laser beam, which emerges coaxially from the telescope's objective.

 **WARNING**

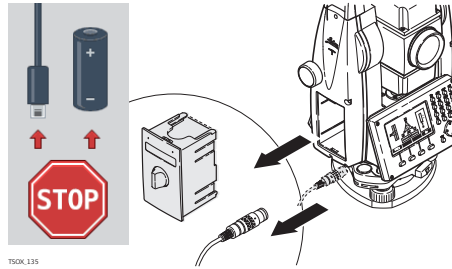

Do NOT remove the battery during operation of the instrument, or during the shut-down procedure.

This can result in a file system error and data loss!

Always switch off the instrument by pressing the On/Off key, and wait until the instrument has shutdown completely before removing the battery.

Table of Contents

In this manual	Chapter	Page
1	Description of the System	8
1.1	System Components	8
1.2	Container Contents	9
1.3	Instrument Components	10
2	User Interface	11
2.1	Keyboard	11
2.2	Screen	12
2.3	Status Icons	12
2.4	Softkeys	14
2.5	Operating Principles	14
2.6	Pointsearch	15
2.7	Graphic Symbols	16
3	Operation	17
3.1	Instrument Setup	17
3.2	Working with the Battery	19
3.3	Data Storage	20
3.4	Main Menu	21
3.5	Q-Survey Program	22
3.6	Distance Measurements - Guidelines for Correct Results	22
4	Settings	24
4.1	Work Settings	24
4.2	Regional Settings	25
4.3	Data Settings	28
4.4	Screen & Audio Settings	29
4.5	EDM Settings	31
4.6	Interface Settings	34
5	Programs - Getting Started	36
5.1	Overview	36
5.2	Starting a Program	37
5.3	Setting the Job	37
5.4	Station Setup	38
6	Programs	39
6.1	Common Fields	39
6.2	Station Setup	39
6.2.1	Starting Station Setup	39
6.2.2	Measuring the target points	42
6.2.3	Station Setup Results	43
6.3	Surveying	45
6.4	Stakeout	46
6.5	Reference Line	48
6.5.1	Overview	48
6.5.2	Defining the Base Line	48
6.5.3	Defining the Reference Line	49
6.5.4	Measure Line & Offset	50
6.5.5	Stakeout	51
6.5.6	Grid Stakeout	52
6.5.7	Line Segmentation	54

6.6	Reference Arc	56
6.6.1	Overview	56
6.6.2	Defining the Reference Arc	56
6.6.3	Measure Line & Offset	57
6.6.4	Stakeout	58
6.7	Reference Plane	60
6.8	Tie Distance	61
6.9	Area & DTM Volume	63
6.10	Remote Height	66
6.11	COGO	67
6.11.1	Starting COGO	67
6.11.2	Inverse and Traverse	67
6.11.3	Intersections	68
6.11.4	Offsets	69
6.11.5	Line - Extension	69
6.12	Road 2D	70
6.13	Road 3D	72
6.13.1	Starting Road 3D	72
6.13.2	Basic Terms	73
6.13.3	Creating or Uploading Alignment Files	77
6.13.4	Stake	78
6.13.5	Check	79
6.13.6	Stake Slope	80
6.13.7	Check Slope	83
6.14	Traverse	84
6.14.1	Overview	84
6.14.2	Starting and Configuring Traverse	85
6.14.3	Measuring Traverse	86
6.14.4	Moving ahead	88
6.14.5	Closing a Traverse	88
7	Favourites	92
7.1	Overview	92
7.2	Target Offset	93
7.2.1	Overview	93
7.2.2	Cylindrical Offset Subprogram	94
7.3	Hidden Point	96
7.4	Check Tie	97
7.5	EDM Tracking	97
7.6	Backsight Check	98
8	Coding	99
8.1	Coding	99
8.2	Quick Coding	100
9	Tools	101
9.1	Adjust	101
9.2	Startup Sequence	101
9.3	System Information	102
9.4	Licence Keys	104
9.5	Instrument Protection with PIN	105
9.6	Loading Software	106

10	Data Management	107
10.1	Manage	107
10.2	Exporting Data	108
10.3	Importing Data	111
10.4	Working with a USB Memory Stick	113
10.5	Working with Bluetooth	114
10.6	Working with Leica FlexOffice	115
11	Check & Adjust	116
11.1	Overview	116
11.2	Preparation	116
11.3	Adjusting Line-of-Sight and Vertical Index Error	117
11.4	Adjusting the Compensator	119
11.5	Adjusting the Tilting Axis Error	120
11.6	Adjusting the Circular Level of the Instrument and Tribrach	121
11.7	Inspecting the Laser Plummet of the Instrument	122
11.8	Servicing the Tripod	122
12	Care and Transport	123
12.1	Care	123
12.2	Transport	123
12.3	Storage	123
12.4	Cleaning and Drying	124
13	Safety Directions	125
13.1	General	125
13.2	Definition of Use	125
13.3	Limits of Use	125
13.4	Responsibilities	126
13.5	Hazards of Use	126
13.6	Laser Classification	128
	13.6.1 General	128
	13.6.2 Distancer, Measurements with Reflectors	128
	13.6.3 Distancer, Measurements without Reflectors (Non-Prism mode)	129
	13.6.4 Electronic Guide Light EGL	130
	13.6.5 Laser Plummet	130
13.7	Electromagnetic Compatibility EMC	131
13.8	FCC Statement, Applicable in U.S.	133
14	Technical Data	134
14.1	Angle Measurement	134
14.2	Distance Measurement with Reflectors	134
14.3	Distance Measurement without Reflectors (Non-Prism mode)	135
14.4	Distance Measurement Reflector (>4.0 km)	136
14.5	Conformity to National Regulations	136
	14.5.1 Products without Communication side cover	136
	14.5.2 Products with Communication side cover	137
14.6	General Technical Data of the Instrument	138
14.7	Scale Correction	141
14.8	Reduction Formulas	143
15	Software Licence Agreement	144
16	Glossary	145

Appendix A	Menu Tree	147
Appendix B	Directory Structure	149
Index		150

1 Description of the System

1.1 System Components

Main components

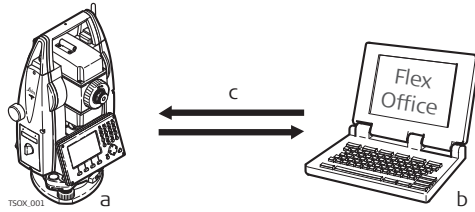

- a) FlexLine plus instrument with FlexField plus firmware
- b) Computer with FlexOffice software
- c) Data transfer

Component	Description
FlexLine plus instrument	An instrument for measuring, calculating and capturing data. Ideally suited for tasks from simple surveys to complex applications. Equipped with a FlexField plus firmware package to complete these tasks. The various lines have a range of accuracy classes and support different features. All lines can be connected with FlexOffice to view, exchange and manage data.
FlexField plus firmware	The firmware package installed on the instrument. Consists of a standard base operating system with optional additional features.
FlexOffice software	An office software consisting of a suite of standard and extended programs for the viewing, exchanging, managing and post processing of data.
Data transfer	Data can be always transferred between a FlexLine plus instrument and a computer via a data transfer cable. For instruments equipped with a Communication side cover data can also be transferred via USB memory stick, USB cable, or Bluetooth.

1.2 Container Contents

Container contents part 1 of 2

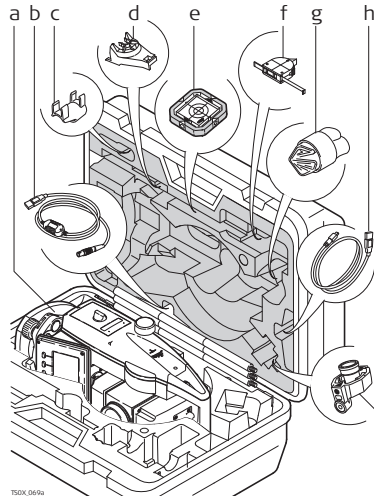

- a) Instrument
- b) GEV189 data cable (USB-RS232)*
- c) GLI115 clip-on bubble*
- d) GHT196 holder for height metre*
- e) CPR105 flat prism*
- f) GHM007 height metre*
- g) Protective cover / Lens hood / Cleaning cloth
- h) GEV223 data cable (USB-mini USB) - for instruments with a Communication side cover
- i) GMP111 mini prism*

* Optional

Container contents part 2 of 2

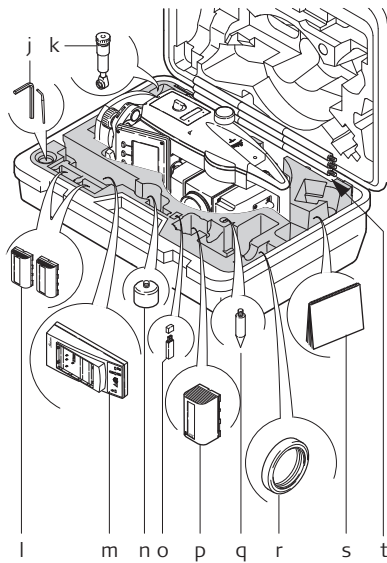

- j) Adjustment tools
 - k) GFZ3 diagonal eyepiece*
 - l) GEB211/GEB212/GEB221/GEB222 batteries*
 - m) GKL211 battery charger*
 - n) GAD105 flat or mini prism adapter*
 - o) MS1 Leica industrial grade USB memory stick - for instruments with a Communication side cover
 - p) GEB212/GEB211/GEB221/GEB222 battery*
 - q) Tip for mini prism pole*
 - r) Counterweight for diagonal eyepiece*
 - s) Manuals
 - t) GLS115 mini prism pole*
- * Optional

1.3 Instrument Components

Instrument components part 1 of 2

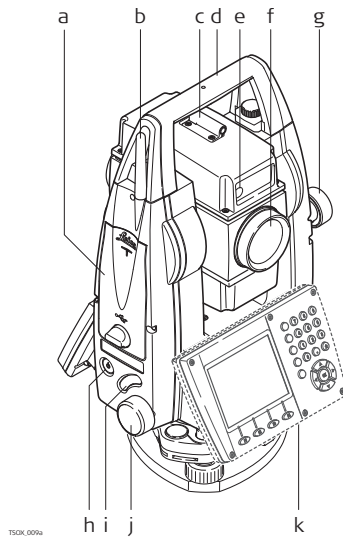

- a) Compartment for USB memory stick and USB cable ports
 - b) Bluetooth antenna
 - c) Optical sight
 - d) Detachable carrying handle with mounting screw
 - e) Electronic Guide Light (EGL)*
 - f) Objective with integrated Electronic Distance Measurement (EDM). Exit for EDM laser beam
 - g) Vertical drive
 - h) On/Off key
 - i) Trigger key
 - j) Horizontal drive
 - k) Second keyboard**
- * Optional for TS06 plus
** Optional for TS06 plus/TS09 plus

Instrument components part 2 of 2

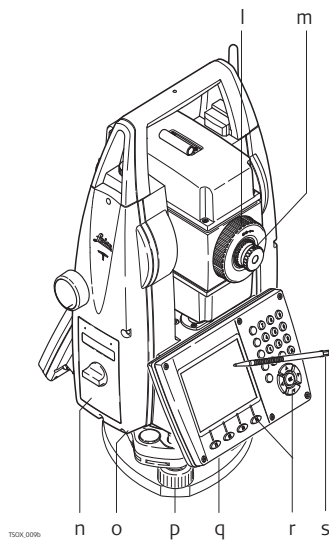

- l) Focusing telescope image
- m) Eyepiece; focusing graticule
- n) Battery cover
- o) Serial interface RS232
- p) Foot screw
- q) Display
- r) Keyboard, model may vary depending on instrument
- s) Stylus

Communication side cover

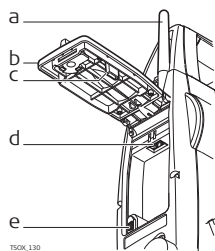

- a) Bluetooth antenna
- b) Compartment lid
- c) USB memory stick cap storage
- d) USB host port
- e) USB device port

2 User Interface

2.1 Keyboard

Keyboard

Color&Touch keyboard

Alphanumeric keyboard

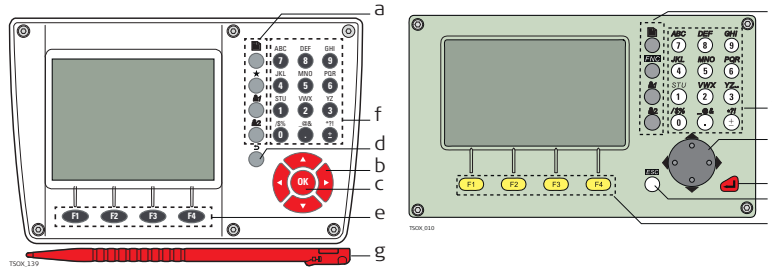



- a) Fixed keys
- b) Navigation key
- c) ENTER key
- d) ESC key
- e) Function keys F1 to F4
- f) Alphanumeric keypad
- g) Stylus

Keys

Key		Description
B&W	C&T	
		Page key. Displays the next screen when several screens are available.
		FNC/Favourites key. Quick-access to measurement supporting functions.
		User key 1. Programmable with a function from the Favourites menu.
		User key 2. Programmable with a function from the Favourites menu.
		Navigation key. Controls the focus bar within the screen and the entry bar within a field.
		ENTER key. Confirms an entry and continues to the next field. When this key is pressed for three seconds, the instrument turns off.
		ESC key. Quits a screen or edit mode without saving changes. Returns to next higher level.
		Function keys that are assigned the variable functions displayed at the bottom of the screen.
		Alphanumeric keypad for entry of text and numerical values.

Sidecover keys

Key	Description
	On / Off key. Switches the instrument on or off.
	Trigger key. Quick key programmable with functions Meas or Dist if desired. The trigger key can be programmed in the Settings screen. Refer to "4.1 Work Settings".

2.2

Screen

Screen

The instruments are available with Black&White or with Color&Touch display.

 All screens shown in this manual are examples. It is possible that local firmware versions are different to the basic version.

Black&White screen:

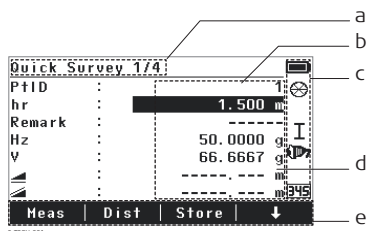

- a) Title of screen
- b) Focus in screen. Active field
- c) Status icons
- d) Fields
- e) Softkeys

Color&Touch screen:

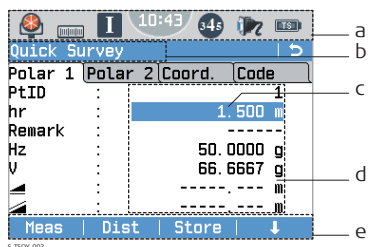

- a) Status icons
- b) Title of screen
- c) Focus in screen. Active field
- d) Fields
- e) Softkeys

 Tap on an icon, field or tab to run a function.











2.3

































Status Icons

Description

The icons provide status information related to basic instrument functions. Depending on the firmware version, different icons are displayed.

Icons

Icon		Description
B&W	C&T	
		Non-prism EDM mode for measuring to all targets. For C&T: Tapping the icon opens the EDM Settings screen.
		Leica standard prism is selected. For C&T: Tapping the icon opens the EDM Settings screen.
		Leica mini prism is selected. For C&T: Tapping the icon opens the EDM Settings screen.
		Leica mini 0 prism is selected. For C&T: Tapping the icon opens the EDM Settings screen.
		Leica 360° prism is selected. For C&T: Tapping the icon opens the EDM Settings screen.

Icon		Description
B&W	C&T	
		Leica 360° mini prism is selected. For C&T: Tapping the icon opens the EDM Settings screen.
		Leica 360° MPR122 prism is selected. For C&T: Tapping the icon opens the EDM Settings screen.
		Leica reflector tape is selected. For C&T: Tapping the icons opens the EDM Settings screen.
		User defined prism is selected. For C&T: Tapping the icons opens the EDM Settings screen.
-		Indicates EDM measurement activity. For C&T: Tapping the icons opens the EDM Settings screen.
-		indicates an active laser pointer. For C&T: Tapping the icon opens the EDM Settings screen.
I		Indicates telescope position in face I. For C&T: Tapping the icon opens the Level & Plummet screen.
II		Indicates telescope position in face II. For C&T: Tapping the icon opens the Level & Plummet screen.
		Compensator is on. For C&T: Tapping the icon opens the Level & Plummet screen.
		Compensator is off. For C&T: Tapping the icon opens the Level & Plummet screen.
		Compensator out of range. For C&T: Tapping the icon opens the Level & Plummet screen.
		Keypad is set to numeric mode. Displayed when an editable field is highlighted. For C&T: Tapping the icon switches to alphanumeric mode.
		Keypad is set to alphanumeric mode. Displayed when an editable field is highlighted. For C&T: Tapping the icon switches to numeric mode.
		RS232 communication port is selected. For C&T: Tapping the icon opens the Interface Settings screen.
		Bluetooth communication port is selected. If there is a cross beside the icon, the Bluetooth communication port is selected, but the status is inactive. For C&T: Tapping the icon opens the Interface Settings screen.
		USB communication port is selected. For C&T: Tapping the icon opens the Interface Settings screen.
AUTO		Communication is set to auto detect. For C&T: Tapping the icon opens the Interface Settings screen.
		The battery symbol indicates the level of the remaining battery capacity, 100% full shown in the example. For C&T: Tapping the icon opens the Info screen.
!		Offset is active.
	-	Indicates that horizontal angle is set to left side angle measurement (anticlockwise).

2.4

Softkeys

Description

Softkeys are selected using the relevant F1 to F4 function key. This chapter describes the functionality of the common softkeys used by the system. The more specialised softkeys are described where they appear in the program chapters.



Common softkey functions

Key	Description
Cont	If entry screen: Confirms measured or entered values and continues the process. If message screen: Confirms message and continues with selected action or returns to the previous screen to reselect an option.
Back	To return to the last active screen.
Default	To reset all editable fields to their default values.
Dist	To start distance and angle measurements without saving the measured values.
EDM	To view and change EDM settings. Refer to "4.5 EDM Settings".
ENH	To open the manual coordinate entry screen.
Find	To search for an entered point.
List	To display the list of available points.
Meas	To start distance and angle measurements and save the measured values.
Quit	To exit the screen or program.
Store	To save the displayed values.
View	To display the coordinate and job details of the selected point.
-> ABC	To change the keypad operation to alphanumeric.
-> 345	To change the keypad operation to numerical.
↓	To display the next softkey level.
↑	To return to the first softkey level.

2.5

Operating Principles

Turn instrument on/off

- To turn the instrument on or off, use the  On/Off key on the side cover of the instrument.
- Alternatively, the instrument can be turned off by pressing the  /  key for three seconds.

Selection of language

After switching on the instrument the user is able to choose their preferred language. The language choice screen is only shown if multiple languages are loaded onto the instrument and **Lang.Choice: On** is set in the instrument settings. Refer to "4.2 Regional Settings".

Alphanumeric keypad

- The alphanumeric keypad is used to enter characters directly into editable fields.
- Numeric fields: Can only contain numerical values. By pressing a key of the keypad the number will be displayed.
 - Alphanumeric fields: Can contain numbers and letters. By pressing a key of the keypad the first character written above that key will be displayed. By pressing several times you can toggle through the characters. For example: 1->S->T->U->1->S....

Edit fields

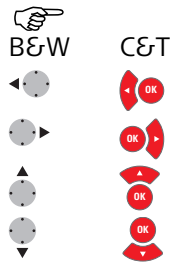

ESC Deletes any change and restores the previous value.

Moves the cursor to the left

Moves the cursor to the right.

Inserts a character at the cursor position.

Deletes the character at the cursor position.



In edit mode the position of the decimal place cannot be changed. The decimal place is skipped.

Special characters

Character	Description
*	Used as wildcards in search fields for point numbers or codes. Refer to "2.6 Pointsearch".
+/-	In the alphanumeric character set "+" and "-" are treated as normal alphanumeric characters with no mathematical function.  "+" / "-" only appear in front of an entry.

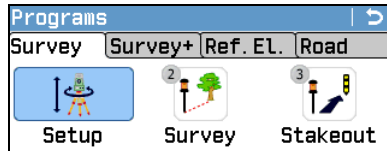

In this example selecting 2 on an alphanumeric keyboard would start the Survey program.

2.6

Pointsearch

Description

Pointsearch is a function used by programs to find measured or fixed points in the memory storage.

It is possible to limit the point search to a particular job or to search the whole storage. The search procedure always finds fixed points before measured points that fulfil the same search criteria. If several points meet the search criteria, then the results are ordered according to the entry date. The instrument finds the most recent fixed point first.

Direct search

By entering an actual point number, for example 402, and pressing **Search**, all points within the selected job and with the corresponding point number are found.

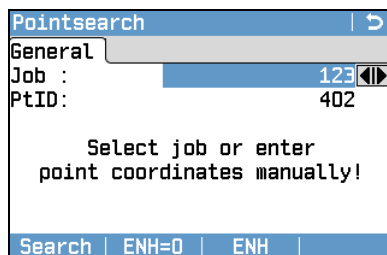

Search

To search for matching points within the selected job.

ENH=0

To set all ENH coordinates for the point ID to 0.

Wildcard search

The wildcard search is indicated by a "*". The asterisk is a place holder for any following sequence of characters. Wildcards should be used if the point number is not fully known, or to search for a batch of points.

Examples of point searches

- * All points are found.
- A All points with exactly the point number "A" are found.
- A* All points starting with "A" are found, for example, A9, A15, ABCD, A2A.
- *1 All points containing only one "1" are found, for example, 1, A1, AB1.
- A*1 All points starting with "A" and containing only one "1" are found, for example, A1, AB1, A51.

















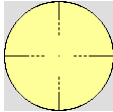

2.7

Graphic Symbols

Graphic symbols

In some programs, a graphical display is shown. The graphical display

- provides a guide to find the point to be staked out.
- allows for a better overall understanding of how the data being used and measured relates to each other.

Element	Description
	Point to be staked / known point
	Instrument
	Current position of prism (measurement with Dist)
	Forward/backwards distance to point
	Side distance to point
	Height distance to point
	The stakeout point is the same as the measured point. The difference between stakeout point and measured point is ≤ 0.03 m.
	Circle around the stake out point, supporting the detail view, radius = 0.5 m
	Fixpoint
	Centre point of an arc or circle
	Measured point
	Black squares around the point symbol indicate the plane points.
	New point
	Reference line/arc, straight, curve or spiral from start point to end point
	Extension of reference line/arc, straight, curve or spiral
	Perpendicular distance to the reference line/arc, straight, curve or spiral
	Boundary of an area
	Connection between last measured/selected point and first point of an area
	Boundary of breaklines
	Breaklines of an area

3

Operation

3.1

Instrument Setup

Description

This topic describes an instrument setup over a marked ground point using the laser plummet. It is always possible to set up the instrument without the need for a marked ground point.



Important features

- It is always recommended to shield the instrument from direct sunlight and avoid uneven temperatures around the instrument.
- The laser plummet described in this topic is built into the vertical axis of the instrument. It projects a red spot onto the ground, making it appreciably easier to centre the instrument.
- The laser plummet cannot be used with a tribrach equipped with an optical plummet.

Tripod

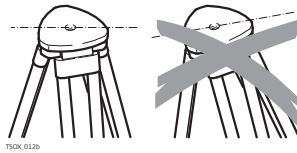

When setting up the tripod pay attention to ensuring a horizontal position of the tripod plate. Slight corrections of inclination can be made with the foot screws of the tribrach. Larger corrections must be done with the tripod legs.

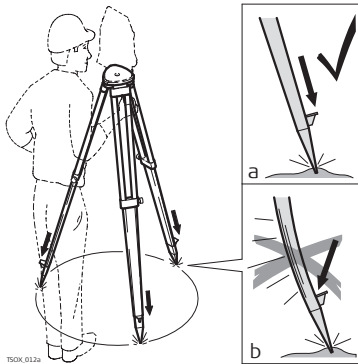

Loosen the clamping screws on the tripod legs, pull out to the required length and tighten the clamps.

- a) In order to guarantee a firm foothold sufficiently press the tripod legs into the ground.
- b) When pressing the legs into the ground note that the force must be applied along the legs.

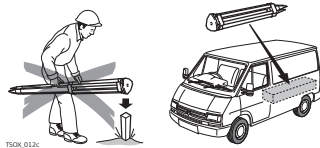

Careful handling of tripod.

- Check all screws and bolts for correct fit.
- During transport, always use the cover supplied.
- Use the tripod only for surveying tasks.

Setup step-by-step

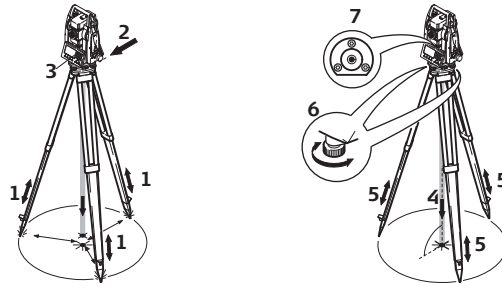

1. Extend the tripod legs to allow for a comfortable working posture. Position the tripod over the marked ground point, centring it as best as possible.
2. Fasten the tribrach and instrument onto the tripod.
3. Turn on the instrument, and, if tilt correction is set to **On**, the laser plummet will be activated automatically, and the **Level & Plummet** screen appears. Otherwise, press the FNC/Favourites key from within any program and select **Level & Plummet**.
4. Move the tripod legs (1) and use the tribrach footscrews (6) to centre the plummet (4) over the ground point.
5. Adjust the tripod legs (5) to level the circular level (7).
6. By using the electronic level, turn the tribrach footscrews (6) to precisely level the instrument. Refer to "Level up with the electronic level step-by-step".
7. Centre the instrument precisely over the ground point by shifting the tribrach on the tripod plate (2).
8. Repeat steps 6. and 7. until the required accuracy is achieved.

Level up with the electronic level step-by-step

The electronic level can be used to precisely level up the instrument using the footscrews of the tribrach.

1. Turn the instrument until it is parallel to two footscrews.
2. Centre the circular level approximately by turning the footscrews of the tribrach.
3. Turn on the instrument, and, if tilt correction is set to On, the laser plummet will be activated automatically, and the **Level & Plummet** screen appears. Otherwise, press the FNC/Favourites key from within any program and select **Level & Plummet**.

 The bubble of the electronic level and the arrows for the rotating direction of the footscrews only appear if the instrument tilt is inside a certain leveling range.

4. Centre the electronic level of the first axis by turning the two footscrews. Arrows show the direction of rotation required. The first axis is levelled, when the bubble is exactly between the squared brackets [] of the single axis bubble tube.

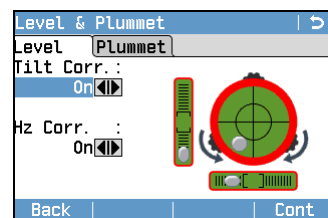

 When levelled correctly, checkmarks are displayed. For the Color&Touch display only: If the instrument is not levelled to one axis, then the icons for the single axis bubble tube and the circular bubble are framed red, else they are black.

5. Centre the electronic level for the second axis by turning the last footscrew. An arrow shows the direction of rotation required.

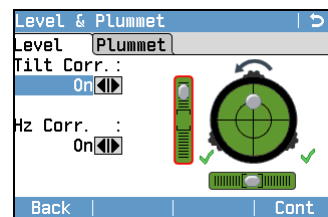

☞ When all three bubbles are centred, the instrument has been perfectly levelled up.

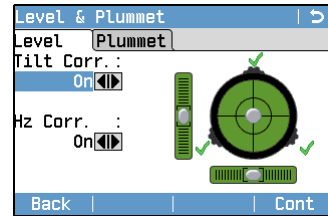

6. Accept with **Cont**.

Change the intensity of the laser plummet

External influences and the surface conditions may require the adjustment of the intensity of the laser plummet.

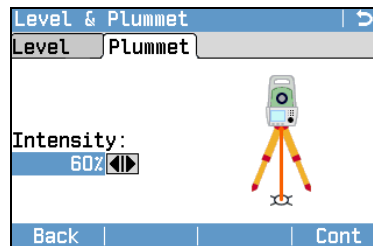

In the **Level & Plummet** screen, adjust the intensity of the laser plummet using the navigation key.

The laser can be adjusted in 20% steps as required.

Position over pipes or holes

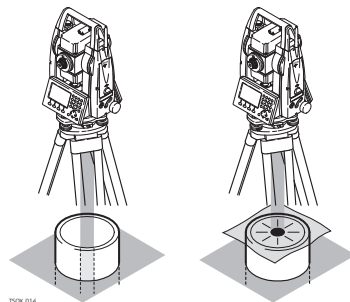

Under some circumstances the laser dot is not visible, for example over pipes. In this case, using a transparent plate enables the laser dot to be seen and then easily aligned to the centre of the pipe.

3.2

Working with the Battery



Charging / first-time use

- The battery must be charged prior to using it for the first time because it is delivered with an energy content as low as possible.
- For new batteries or batteries that have been stored for a long time (> three months), it is effectual to make only one charge/discharge cycle.
- The permissible temperature range for charging is between 0°C to +40°C/+32°F to +104°F. For optimal charging we recommend charging the batteries at a low ambient temperature of +10°C to +20°C/+50°F to +68°F if possible.
- It is normal for the battery to become warm during charging. Using the chargers recommended by Leica Geosystems, it is not possible to charge the battery if the temperature is too high.

Operation / discharging

- The batteries can be operated from -20°C to +50°C/-4°F to +122°F.
- Low operating temperatures reduce the capacity that can be drawn; very high operating temperatures reduce the service life of the battery.
- For Li-Ion batteries, we recommend carrying out a single discharging and charging cycle when the battery capacity indicated on the charger or on a Leica Geosystems product deviates significantly from the actual battery capacity available.

Change the battery step-by-step

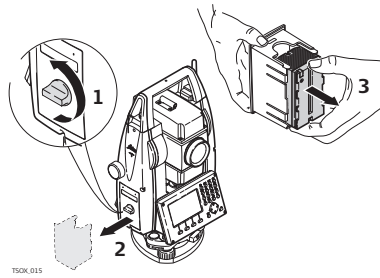

Open the battery compartment (1) and remove the battery holder (2).

Remove the battery from the battery holder (3).

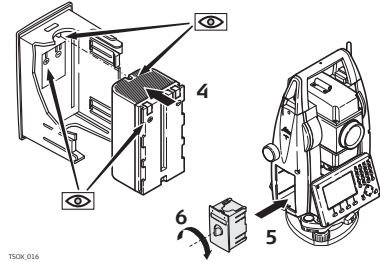

Insert the new battery into the battery holder (4), ensuring that the contacts are facing outward. The battery should click into position.

Insert the battery holder back into the battery compartment (5) and turn the knob to lock the battery holder in place (6).



The polarity of the battery is displayed inside the battery housing.

3.3

Data Storage

Description

An internal memory is included in all instruments. The FlexField plus firmware stores all data in jobs in a database in the internal memory. Data can then be transferred to a computer or other device for post processing via a LEMO cable connected to the serial interface RS232 port.

For instruments fitted with a Communication side cover, data can also be transferred from the internal memory to a computer or other device via:

- a USB memory stick inserted into the USB host port,
- a USB cable connected to the USB device port, or
- via a Bluetooth connection.

Refer to "10 Data Management" for further information on data management and data transfer.





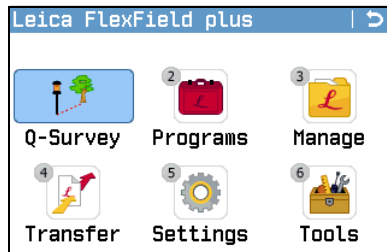

Description

The Main Menu is the starting place for accessing all functionality of the instrument. It is displayed immediately after the **Level & Plummet** screen, after switching on the instrument.



If desired, the instrument can be configured to start in a user-defined place after the Level/Plummet screen, instead of the Main Menu. Refer to "9.2 Startup Sequence".

Main Menu**Description of the Main Menu functions**

Function	Description
 Q-Survey	Quick Survey program to begin measuring immediately. Refer to "3.5 Q-Survey Program".
 Programs	To select and start programs. Refer to "6 Programs".
 Manage	To manage jobs, data, codelists, formats, system memory and USB memory stick files. Refer to "10 Data Management".
 Transfer	To export and import data. Refer to "10.2 Exporting Data".
 Settings	To change EDM configurations, communication parameters and general instrument settings. Refer to "4 Settings".
 Tools	To access instrument-related tools such as check and adjust, personal startup settings, PIN code settings, licence keys, system information and firmware upload. Refer to "9 Tools".

3.5

Q-Survey Program

Description

After switching on and setting up correctly, the instrument is immediately ready for measuring.

Access

Select  **Q-Survey** from the Main Menu.

Q-Survey

Quick Survey		
Polar 1	Polar 2	Coord. Code
PtID	:	1
hr	:	1.500 m
Remark	:	-----
Hz	:	50.0000 g
V	:	66.6667 g
	:	----- m
	:	----- m
Meas		Dist Store ↓

↓ Station

To enter station data and set the station.

↓ Set Hz

To set the orientation to a user defined horizontal direction.

↓ Hz ← / Hz →

To set the horizontal angle reading to the left (anticlockwise) or to the right (clockwise).

↓ Code

To find/enter codes. Refer to "8.1 Coding". Available on page 4/4 or **Code**. Or, on any page, press the FNC/Favourites key and select **Coding**.

3.6

Distance Measurements - Guidelines for Correct Results

Description

An EDM is incorporated into the FlexLine plus instruments. In all versions, the distance can be determined by using a visible red laser beam which emerges coaxially from the telescope objective. There are two EDM modes:

- Prism measurements
- Non-Prism measurements

Non-Prism measurements

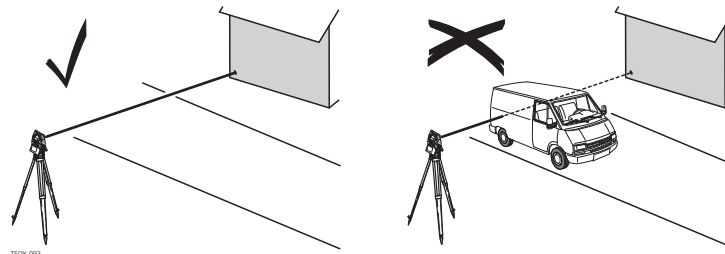

- When a distance measurement is triggered, the EDM measures to the object which is in the beam path at that moment. If a temporary obstruction, for example a passing vehicle, heavy rain, fog or snow is between the instrument and the point to be measured, the EDM may measure to the obstruction.
- Be sure that the laser beam is not reflected by anything close to the line of sight, for example highly reflective objects.
- Avoid interrupting the measuring beam while taking Non-Prism measurements or measurements using reflective foils.
- Do not measure with two instruments to the same target simultaneously.

Prism measurements

- Accurate measurements to prisms should be made in Prism-standard mode.
- Measurements to strongly reflecting targets such as traffic lights in Prism mode without a prism should be avoided. The measured distances may be wrong or inaccurate.
- When a distance measurement is triggered, the EDM measures to the object which is in the beam path at that moment. If for example people, cars, animals, or swaying branches cross the laser beam while a measurement is being taken, a fraction of the laser beam is reflected from these objects and may lead to incorrect distance values.
- Measurements to prisms are only critical if an object crosses the measuring beam at a distance of 0 to 30 m and the distance to be measured is more than 300 m.
- In practice, because the measuring time is very short, the user can always find a way of avoiding unwanted objects from interfering in the beam path.



Due to laser safety regulations and measuring accuracy, using the Long Range Reflectorless EDM is only allowed to prisms that are more than 1000 m (3300 ft) away.

Red laser to prism

- **P-Long (>4.0 km)** mode enables distance measurements of over 4.0 km to standard prisms using the visible red laser beam.

Red laser to reflector tape

- The visible red laser beam can also be used to measure to reflective foils. To guarantee the accuracy the red laser beam must be perpendicular to the reflector tape and it must be well adjusted.
 - Make sure the additive constant belongs to the selected target (reflector).
-



4

Settings



4.1

Work Settings

Access

1. Select  **Settings** from the Main Menu.
2. Select  **Work** from the **Settings** Menu.

Work Settings

Field	Description
Trigger Key1 Trigger Key2	Trigger Key 1 is the top end of the trigger key. Trigger Key 2 is the lower end of the trigger key. Off The trigger key is deactivated. Meas Sets the trigger key with the same function as Meas . Dist Sets the trigger key with the same function as Dist .
USER Key 1 USER Key 2	Configures  or  with a function from the Favourites menu. Refer to "7 Favourites".
Tilt Corr.	Off Tilting compensation deactivated. On 2-axis compensation. Vertical angles refer to the plummet line and the horizontal directions are corrected by the standing axis tilt. For corrections depending on the Hz Corr. setting, refer to the table "Tilt and horizontal corrections".  If the instrument is used on an unstable base, for example a shaking platform or ship, the compensator should be deactivated. This avoids the compensator drifting out of its measuring range and interrupting the measuring process by indicating an error.
Hz Corr.	On Horizontal corrections are activated. For normal operation the horizontal correction should remain active. Each measured horizontal angle will be corrected, depending on the vertical angle. For corrections depending on the Tilt Corr. setting, refer to the table "Tilt and horizontal corrections". Off Horizontal corrections are deactivated.
Face I Def.	Sets the face I in relation to the position of the vertical drive. V-Left Sets face I to be when the vertical drive is on the left of the instrument. V-Right Sets face I to be when the vertical drive is on the right of the instrument.



Tilt and horizontal corrections

Setting		Correction			
Tilt correction	Horizontal correction	Incline longitudinal	Incline transversal	Horizontal collimation	Tilting axis
Off	On	No	No	Yes	Yes
On	On	Yes	Yes	Yes	Yes
Off	Off	No	No	No	No
On	Off	Yes	No	No	No

4.2

Regional Settings

Access



1. Select  **Settings** from the Main Menu.
2. Select  **Regional** from the **Settings** Menu.
3. Press  to scroll through the screens of available settings.

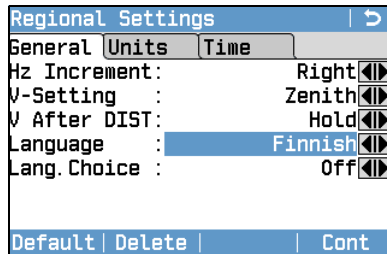

Regional Settings

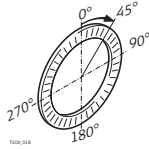
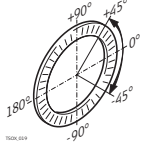
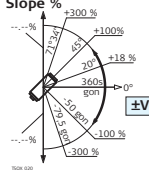

Delete



To delete an inactive language. Available when the language is highlighted.

Field	Description
Hz Increment	<p>Right Set horizontal angle to clockwise direction measurement.</p> <p>Left Set horizontal angle to counter-clockwise direction measurement. Counter-clockwise directions are displayed but are saved as clockwise directions.</p>
V-Setting	<p>Sets the vertical angle.</p> <p>Zenith  Zenith=0°; Horizon=90°.</p> <p>Horizon  Zenith=90°; Horizon=0°. Vertical angles are positive above the horizon and negative below it.</p> <p>Slope [%]  45°=100%; Horizon=0°. Vertical angles are expressed in % with positive above the horizon and negative below it.  The % value increases rapidly. --.-% appears on the display above 300%.</p>

Field	Description
V After DIST	<p>Sets if the vertical angle value recorded is the value that is displayed when Dist or when Store is pressed. The vertical angle field in a measurement screen always shows the running angle, regardless of this setting.</p> <p>Hold The vertical angle value that is recorded is the value that was in the vertical angle field at the time Dist was pressed.</p> <p>Running The vertical angle value that is recorded is the value in the vertical angle field at the time Store is pressed.</p> <p> This setting is not applicable for the program Tie Distance or the favourites Hidden Point and Height Transfer. For these, the vertical angle is always running and the value recorded is the value when Store is pressed.</p>
Language	<p>Sets the chosen language. Several languages can be uploaded onto the instrument. The current loaded language(s) are shown. A selected language can be deleted by pressing Delete. This function is available if more than one language is installed, and the selected language is not the chosen operating language.</p>
Lang.Choice	<p>If multiple languages are loaded, a screen to choose the language can be shown directly after switching on the instrument.</p> <p>On The language screen is shown as the startup screen.</p> <p>Off The language screen is not shown as the startup screen.</p>
Angle Unit	<p>Sets the units shown for all angular fields.</p> <p>° ' " Degree sexagesimal. Possible angle values: 0° to 359°59'59"</p> <p>dec. deg Degree decimal. Possible angle values: 0° to 359.999°</p> <p>gon Gon. Possible angle values: 0 to 399.999 gon</p> <p>mil Mil. Possible angle values: 0 to 6399.99 mil.</p> <p> The setting of the angle units can be changed at any time. The current displayed values are converted according to the selected unit.</p>
Min. Reading	<p>Sets the number of decimal places shown for all angular fields. This is for data display and does not apply to data export or storage.</p> <p>°''' (0° 00' 0.1"/0° 00' 01"/0° 00' 05"/ 0° 00' 10")</p> <p>dec. deg (0.0001 / 0.0005 / 0.001)</p> <p>gon (0.0001 / 0.0005 / 0.001)</p> <p>mil (0.01 / 0.05 / 0.1)</p>
Dist. Unit	<p>Sets the units shown for all distance and coordinate related fields.</p> <p>meter Metres [m].</p> <p>US-ft US feet [ft].</p> <p>INT-ft International feet [fi].</p> <p>ft-in/16 US feet-inch-1/16 inch [ft].</p>

Field	Description
Dist.Decimal	Sets the number of decimal places shown for all distance fields. This is for data display and does not apply to data export or storage. 3 Displays distance with three decimals. 4 Displays distance with four decimals.
Temp. Unit	Sets the units shown for all temperature fields. °C Degree Celsius. °F Degree Fahrenheit.
Press.Unit	Sets the units shown for all pressure fields. hPa Hecto Pascal. mbar Millibar. mmHg Millimeter mercury. inHg Inch mercury.
Grade Unit	Sets how the slope gradient is calculated. h:v Horizontal : Vertical, for example 5 : 1. v:h Vertical : Horizontal, for example 1 : 5. % (v/h x 100), for example 20 %.
Time (24h)	The current time.
Date	Shows an example of the selected date format.
Format	dd.mm.yyyy , How the date is shown in all date-related fields. mm.dd.yyyy or yyyy.mm.dd



Access

1. Select  **Settings** from the Main Menu.
2. Select  **Data** from the **Settings** Menu.
3. Press  to scroll through the screens of available settings.



Data Settings

Field	Description
Double PtID	Sets if multiple points are able to be recorded with the same point ID in the same job. Allowed Allows multiple points with the same point ID. Not Allowed Does not allow multiple points with the same point ID.
Sort Type	Time Lists are sorted by time of entry. PtID Lists are sorted by Point IDs.
Sort Order	Descending Lists are ordered in descending order of sort type. Ascending Lists are ordered in ascending order of sort type.
Code Record	Sets if the codeblock is saved before or after the measurement. Refer to "8 Coding".
Code	Sets if the code will be used for one, or many, measurements. Reset after Rec The set code is cleared from the measurement screen after Meas or Store is selected. Permanent The set code remains in the measurement screen until manually deleted.
Data Output	Sets the location for data storage. Internal Memory All data is recorded in the internal memory. Interface Data is recorded via the serial interface, the USB device port or Bluetooth, depending on the port selected in the Interface Settings screen. This Data Output setting is only required if an external storage device is connected and measurements are started at the instrument with Dist/Store or Meas. This setting is not required if the instrument is totally controlled by a datalogger.
GSI-Format	Sets the GSI output format. GSI 8 81..00+12345678 GSI 16 81..00+1234567890123456
GSI-Mask	Sets the GSI output mask. Mask 1 PtID, Hz, V, SD, ppm+mm, hr, hi. Mask 2 PtID, Hz, V, SD, E, N, H, hr. Mask 3 StationID, E, N, H, hi (Station). StationID, Ori, E, N, H, hi (Station Result). PtID, E, N, H (Control). PtID, Hz, V (Set Azimuth). PtID, Hz, V, SD, ppm+mm, hr, E, N, H (Measurement).

Access

1. Select  **Settings** from the Main Menu.
2. Select  **Screen...** from the **Settings** Menu.
3. Press  to scroll through the screens of available settings.

Screen & Audio Settings

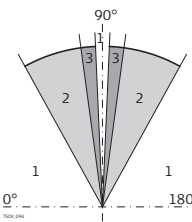

Field	Description	
Display Ill.	Off to 100%	Sets the display illumination in 20% steps.
Keyb. Ill.	Available for Color&Touch display only.	
	On	The keyboard illumination is activated.
	Off	The keyboard illumination is deactivated.
Reticle Ill.	Off to 100%	Sets the reticle illumination in 10% steps.
Touch Screen	Available for Color&Touch display only.	
	On	The touch screen is activated.
	Off	The touch screen is deactivated.
		Press Calib. to calibrate the touch screen. Follow the instructions on the screen
Displ.Heater	Available for Black&White display only.	
	On	The display heater is activated.
	Off	The display heater is deactivated.
		The display heater is automatically activated when the display illumination is on and the instrument temperature is $\leq 5^{\circ}\text{C}$.
Contrast	0% to 100%	Available for Black&White display only. Sets the display contrast in 10% steps.
Auto-Off	Enable	The instrument switches off after 20 minutes without any activity, for example no key pressed or vertical and horizontal angle deviation is $\leq \pm 3^{\circ}$.
	Disable	Automatic switch-off is deactivated.
		Battery discharges quicker.
Screensaver	after 1 min, after 2 min, after 5 min, after 10 min	The screensaver is activated and starts after the selected time.
	Off	The screensaver is deactivated.
Beep	The beep is an acoustic signal after each key stroke.	
	Normal	Normal volume.
	Loud	Increased volume.
	Off	Beep is deactivated.

Field	Description	
Sector Beep	On	<p>Sector beep sounds at right angles (0°, 90°, 180°, 270° or 0, 100, 200, 300 gon).</p>  <p>1) No beep. 2) Fast beep; from 95.0 to 99.5 gon and 105.0 to 100.5 gon. 3) Permanent beep; from 99.5 to 99.995 gon and from 100.5 to 100.005 gon.</p>
	Off	Sector Beep is deactivated.
Stakeout Beep	On	The instrument beeps when the distance from the current position to the point to be staked is ≤ 0.5 m. The closer the prism is to the point to be staked the faster the beeps will be.
	Off	Beep is deactivated.

Description

The settings on this screen define the active EDM, Electronic Distance Measurement. Different settings for measurements are available with Non-Prism (NP) and Prism (P) EDM modes.

Access

1. Select  **Settings** from the Main Menu.
2. Select  **EDM** from the **Settings** Menu.

EDM Settings

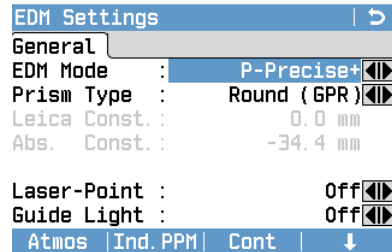

Atmos

To enter atmospheric data ppm.

Ind.PPM

To enter an individual ppm value.

↓ Scale



To enter projection scale details.



↓ Signal

To view EDM Signal reflection value.

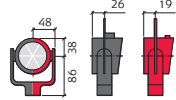
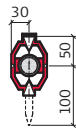
↓ Freq.

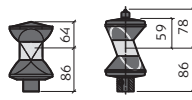
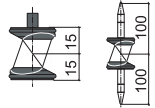
To view the EDM frequency.

Field	Description
EDM Mode	<p>P-Precise+ Fine measuring mode for highest precision measurements with prisms (1.5 mm + 2 ppm).</p> <p>P-Precise & Fast Quick measuring mode with prisms, with higher measuring speed and high accuracy (2 mm + 2 ppm).</p> <p>P-Tracking For continuous distance measurements with prisms (3 mm + 2 ppm).</p> <p>Tape For distance measurements using Retro reflective targets (5 mm + 2 ppm).</p> <p>P-Long (>4.0 km) For long range distance measurements with prisms (5 mm + 2 ppm).</p> <p>NP-Precise For distance measurements without prisms (2 mm + 2 ppm; >500 m: 4 mm + 2 ppm).</p> <p>NP-Tracking For continuous distance measurements without prisms (5 mm + 3 ppm).</p>
Prism Type	<p>Round (GPR)  Standard prism GPR121/GPR111 Leica Const.: 0.0 mm</p> <p>Mini (GMP)  GMP111 Leica Const.: +17.5 mm</p> <p>Mini0 (GMP111-0)  GMP111-0 Leica Const.: 0.0 mm</p> <p>Jp Mini (SMP222) Miniprism Leica Const.: +34.4 mm</p> <p>360° (GRZ4)  GRZ4/GRZ122 Leica Const.: +23.1 mm</p> <p>360°Mini (GRZ101)  GRZ101 Leica Const.: +30.0 mm</p>

Field	Description
	<p>Tape (GZM)  Leica Const.: +34.4 mm</p> <p>360° (MPR122)  MPR122 Leica Const.: +28.1 mm</p> <p>None Without prism Leica Const.: +34.4 mm</p> <p>User 1 / User 2 For any prism modes, the user can define two of their own prisms. Constants can be entered in mm in either Leica Const. or Abs. Const.. For example: User prism constant = -30.0 mm Leica Const. = +4.4 mm (34.4 + -30 = 4.4) Abs. Const. = -30.0 mm</p>
Leica Const.	<p>This field displays the Leica prism constant for the selected Prism Type. Where Prism Type is User 1 or User 2 this field becomes editable to set a user defined constant. Input can only be made in mm. Limit value: -999.9 mm to +999.9 mm.</p>
Abs. Const.	<p>This field displays the absolute prism constant for the selected Prism Type. Where Prism Type is User 1 or User 2 this field becomes editable to set a user defined constant. Input can only be made in mm. Limit value: -999.9 mm to +999.9 mm.</p>
Laser-Point	<p>Off Visible laser beam is deactivated.</p> <p>On Visible laser beam for visualising the target point is activated.</p>
Guide Light	<p>Off Guide Light is deactivated.</p> <p>On Guide Light is activated. The person at the prism can be guided by the flashing lights directly to the line of sight. The light points are visible up to a distance of 150 meters. This is useful when staking out points. Working range: 5 m to 150 m (15 ft to 500 ft). Positioning accuracy: 5 cm at 100 m (1.97" at 330 ft).</p> <p>a) Flashing red diode b) Flashing yellow diode</p>

EDM Settings - Enter Atmospheric Data

This screen enables the entry of atmospheric parameters. Distance measurement is influenced directly by the atmospheric conditions of the air in which the measurements are taken. In order to take these influences into consideration distance measurements are corrected using atmospheric correction parameters.

The refraction correction is taken into account in the calculation of the height differences and the horizontal distance. Refer to "14.7 Scale Correction" for the application of the values entered in this screen.

 When **PPM=0** is selected, the Leica standard atmosphere of 1013.25 mbar, 12°C, and 60% relative humidity is applied.

EDM Settings - Enter Projection Scale

This screen enables entry of the scale of projection. Coordinates are corrected with the PPM parameter. Refer to "14.7 Scale Correction" for the application of the values entered on this screen.

EDM Settings - Enter Individual PPM

This screen enables the entry of individual scaling factors. Coordinates and distance measurements are corrected with the PPM parameter. Refer to "14.7 Scale Correction" for the application of the values entered on this screen.

EDM Settings - EDM Signal Reflection

This screen tests the EDM signal strength (reflection strength) in steps of 1%. Enables optimal aiming at distant, barely visible, targets. A percentage bar and a beeping sound, indicate the reflection strength. The faster the beep the stronger the reflection.

ppm handling**General handling**

Handling of	Geom.ppm	Atmos. ppm	Indiv. ppm
Slope distance	Not applied	Applied	Applied
Horizontal distance	Not applied	Applied	Applied
Coordinates	Applied	Applied	Applied

Exceptions

- Program Stakeout
Geometric reduction values are applied to calculate and display the horizontal distance difference so that the position of points to be staked is found correctly.
- LandXML Data
To import and use the measurements into LGO, the distances recorded in LandXML differ from the distances on the instrument.

Handling of	Geom. ppm	Atmos. ppm	Indiv. ppm	ppm tag
Slope distance	Not applied	Applied	Not applied	Available
Horizontal distance	Applied	Applied	Applied	Unavailable
Coordinates	Applied	Applied	Applied	Unavailable



4.6

Interface Settings

Description

For data transfer the communication parameters of the instrument must be set.

Access

1. Select  **Settings** from the Main Menu.
2. Select  **Interface** from the **Settings** Menu.

Interface Settings

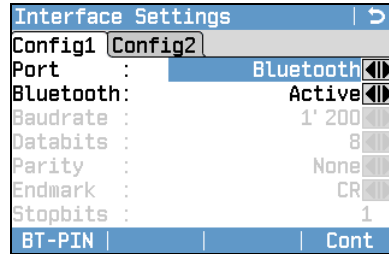

BT-PIN

To set a PIN code for the Bluetooth connection.



This softkey is only available for instruments with a Communication side cover. The default Bluetooth PIN is '0000'.

Default

To reset the fields to the default Leica standard settings. Available for **RS232**.

Field	Description
Port :	Instrument port. If a Communication side cover is fitted the options are selectable. If there is no Communication side cover the value is set to RS232 and is uneditable. RS232 Communication is via the serial interface. USB Communication is via the USB host port. Bluetooth Communication is via Bluetooth. Automatically Communication is set to auto detect.
Bluetooth:	Active Bluetooth sensor is activated. Inactive Bluetooth sensor is deactivated.

The following fields are active only when **Port : RS232** is set.

Field	Description
Baud rate:	Speed of data transfer from receiver to device in bits per second. 1'200, 2'400, 4'800, 9'600, 14'400, 19'200, 38'400, 57'600, 115'200, Topcon, Sokkia
Data bits:	Number of bits in a block of digital data. 7 Data transfer is realised with 7 databits. 8 Data transfer is realised with 8 databits.
Parity :	Even Even parity. Available if data bit is set to 7. Odd Odd parity. Available if data bit is set to 7. None No parity. Available if data bit is set to 8.
Endmark :	CR/LF The terminator is a carriage return followed by a line feed. CR The terminator is a carriage return.
Stop bits: 1	Number of bits at the end of a block of digital data.
Acknowledge:	On Acknowledgement expected from other device after data transfer received. An error message will display if no acknowledgement is returned. Off No acknowledgement expected after data transfer.

Leica standard settings

When **Default** is selected the communication parameters are reset to the default Leica standard settings:

- 115200 Baud, 8 Databit, No Parity, CR/LF Endmark, 1 Stopbit.
-

Interface plug connections

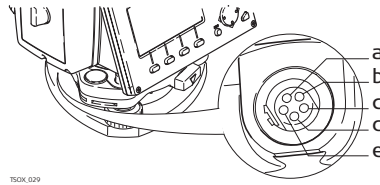

- a) External battery
 - b) Not connected / inactive
 - c) GND
 - d) Data reception (TH_RXD)
 - e) Data transfer (TH_TXD)
-

5

Programs - Getting Started

5.1

Overview

Description

Programs are predefined programs, that cover a wide spectrum of surveying duties and facilitate daily work in the field. The following programs are available, although program packages for each FlexLine plus instrument may vary from that stated below:



Program	TS06 plus	TS09 plus
Station Setup	✓	✓
Survey	✓	✓
Stakeout	✓	✓
Reference Line	✓	✓
Reference Arc	✓	✓
Reference Plane	✓	✓
Tie Distance	✓	✓
COGO	✓	✓
Area & DTM Volume	✓	✓
Remote Height	✓	✓
Road 2D	✓	✓
Road 3D	Optional	✓
Traverse	Optional	✓



Only softkeys unique to the programs are explained in the program chapters. Refer to "2.4 Softkeys" for descriptions of the common softkeys.

5.2 Starting a Program

Access

1. Select  **Programs** from the Main Menu.
2. Press  to move through the screens of available programs.
3. Press the number of the program (for Black&White display) or tab on an icon (for Color&Touch display) to select the specified program in the **Programs** Menu.

Pre-settings screens

Pre-settings for Survey is shown as an example. Any additional settings for particular programs are explained within the chapters for those programs.

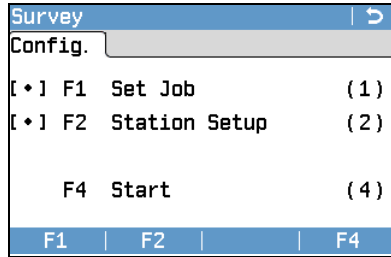

[•] = Setting has been made.
[] = Setting has not been made.

F1-F4
To select menu item.

Field	Description
F1 Set Job	To define the job where data will be saved. Refer to "5.3 Setting the Job".
F2 Station Setup	To determine the station coordinates and station orientation. Refer to "5.4 Station Setup".
F4 Start	Starts the selected program.

5.3 Setting the Job

Description

All data is saved in Jobs, like file directories. Jobs contain measurement data of different types, for example measurements, codes, fixed points, or stations. Jobs are individually manageable and can be exported, edited or deleted separately.

Access

Select **F1 Set Job** in **Config.** screen.

Select Job

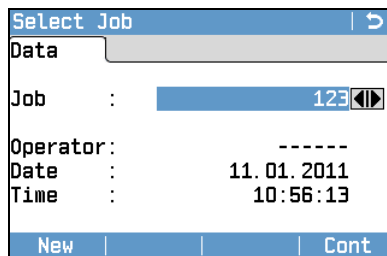

New
To create a new job.

Field	Description
Job	Name of an existing job to be used.
Operator	Name of operator, if entered.
Date	Date the selected job was created.
Time	Time the selected job was created.

Next step

- Either, press **Cont** to continue with the selected job.
- Or, press **New** to open the **Enter Job Data** screen and create a new job.

Recorded data

Once a job is set up, all subsequent recorded data will be stored in this job.
 If no job was defined and a program was started, or if in **Q-Survey** and a measurement was recorded, then the system automatically creates a new job and names it "Default".

Next step

Press **Cont** to confirm the job and return to the **Config.** screen.

5.4**Station Setup****Description**

All measurements and coordinate computations are referenced to the set station coordinates and orientation.

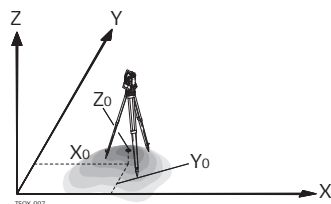
Station coordinate calculation

Directions

X Easting

Y Northing

Z Height

Station coordinates

X0 Easting coordinate of station

Y0 Northing coordinate of station

Z0 Height of station

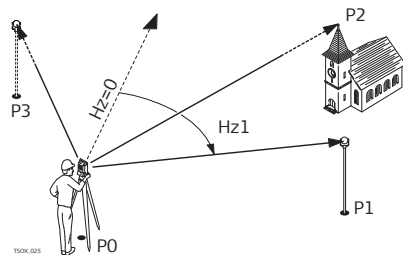
Station orientation calculation

P0 Instrument station

Known coordinates

P1 Target point

P2 Target point

P3 Target point

Calculations

Hz1 Station orientation

Access

Select **F2 Station Setup** in **Config.** screen.

Next step

The Station Setup program begins. Refer to "6.2 Station Setup" for information on the Station Setup process.



If no station was set and a program was started, then the last station is set as the current station and the current horizontal direction is set as the orientation.

6



Programs

6.1

Common Fields

Description of fields

The following table describes common fields that are found within the firmware programs. These fields are described here once and not repeated in the program chapters unless the field has a specific meaning within that program.

Field	Description
PtID, Point, Point 1	Point ID of the point.
hr	Height of the reflector.
Remark / Code	Remark or Code name depending on the coding method. Three coding methods are available: <ul style="list-style-type: none"> • Remark coding: This text is stored with the corresponding measurement. The code is not related to a codelist, it is just a simple remark. A codelist on the instrument is not necessary. • Expanded coding with codelist: Press ↓ Code. The code that was entered is searched for within the code list and it is possible to see, change and/or add attributes to the code. If a code is selected the field name will change to Code. To toggle through the codelist, change to page 4/4 for Black&White displays or to page Code for Color&Touch displays. • Quick coding: Press ↓ Q-Code and enter the shortcut to the code. The code is selected and the measurement starts. The field name will change to Code.
Hz	Horizontal direction to the point.
V	Vertical angle to the point.
	Horizontal distance to the point.
	Slope distance to the point.
	Height to the point.
East	Easting coordinate of the point.
North	Northing coordinate of the point.
Height	Height coordinate of the point.

6.2

Station Setup

6.2.1

Starting Station Setup

Description

Station Setup is a program used when setting up a station, to determine the station coordinates and station orientation. A maximum number of 10 known points can be used to determine the position and orientation.

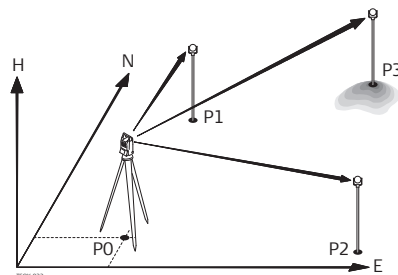

- P0 Instrument station
- P1 Known point
- P2 Known point
- P3 Known point



Setup methods

The following setup methods are available:

Setup method	Description
Orientation with Angle	The station is known. Aim at a target to set the orientation.
Orientation with Coordinates	The station and target coordinates are known. Aim at a target to set the orientation.
Height Transfer	The station is known, a new station height must be computed. Measure to one or more known targets to compute new height for the station.
Resection	The station is unknown. Measure to two or more target points to compute station coordinates and orientation. Scale setting is configurable.
Helmert Resection	<p>The station is unknown. Measure to two or more target points to compute station coordinates and orientation. The measured angles and distances are adjusted, based on coordinates of a local and global system.</p> <p>A 2D Helmert transformation is used, with four (shift x, shift y, rotation and scale) or three (shift x, shift y, rotation) parameters, depending on the scale setting in the configuration. Points can be defined as 1D, 2D or 3D.</p>
Local Resection	<p>The station is unknown. Measure distances to two points:</p> <ul style="list-style-type: none">• To the origin ($E = 0, N = 0, H = 0$) of the coordinate system• To a point the North or East direction of the coordinate system <p>Scale and standard deviation are not calculated.</p>

Each setup method requires different input data and a different number of target points.

Access

1. Select  **Programs** from the Main Menu.
2. Select  **Station Setup** from the **Programs** Menu.
3. Select a job. Refer to "5.3 Setting the Job".
4. Select **F2 Settings**:
 - Set the standard deviation limits for the position, height, Hz orientation, and the Face I-II difference. For **Local Resection**, define the positive North or positive East axis. For **Resection Helmert**, set the distance weighting that is used in the calculation of the station height in the **Resection**. Set **Calc.new Scale: Yes** to calculate the scale for the setup methods **Resection** and **Resection Helmert**. The scale can then be set at the end of the **Resection** calculation. Measured distances are always reduced with the scale set on the instrument. To get a correct result from the scale calculation in **Resection**, the **Scale PPM** in the **EDM Settings** screen must be set to 0.
 - Press **Cont** to save the limits and return to the **Stn.Setup** screen.
5. Select **F4 Start** to begin the program.

Enter Station Data

Enter Station Data

Data

Method : Ori. with Coord.

Station: Default

hi : 1.400 m

Find | List | ENH

1. Select the desired setup method.
 2. Enter the station number or press **Find** or **List** to select an existing point. If the entered station number can not be found in the current job, then the **Point Search** screen appears. Select a different job to search or press **ENH** to enter the coordinates manually. **ENH** is only available for the methods Ori. with Angle, Ori. with Coord. and H-Trans.
 3. For all methods except Ori. with Angle and Local Resection, press **Cont** to continue to the **Enter Target Point** screen.
For the Ori. with Angle method, **Cont** continues to the **Manual Angle Setting** screen. Refer to "6.2.2 Measuring the target points", "Sight target point".
For the Local Resection method, **Cont** continues to the **Meas. Pt1: Origin (0/0/0)** screen. The first point measured is the origin of the coordinate system. The second point measured is, depending on the setting, either the North or East direction of the coordinate system.
 4. **Enter Target Point:** Enter the PtID of the target. Press **Cont** to search for the point in the current job. Select the desired point or enter new coordinates and continue to the **Sight target point!** screen. Refer to "6.2.2 Measuring the target points", "Sight target point".
-

Manual Angle Setting Available for **Method: Ori. with Angle** only.
Enter the PtID and height of the target. Measure the Hz angle and repeat the measurement in the other face by pressing **↓ Face**. Press **Set** to set the new orientation. The station setup is complete.

Sight target point The remaining screens are available for all methods except Ori. with Angle and Local Resection.

In the **Sight target point!** screen:

2 / I: Indicates that the second point was measured in face I.

2 / I II: Indicates that the second point was measured in faces I and II.

Sight the target point and select **Meas**, or **Dist** and **Store** to measure to the target point.

Station Setup Result

Setup Result	
Select	
Accur. Posit.	0.011 m
Accur. Height	0.052 m <input checked="" type="checkbox"/>
Accur. Hz	0.0208 g <input checked="" type="checkbox"/>
F1	Measure more points
F2	Measure in other face
F3	Access Tolerances
F4	Compute
F1	F2
F3	F4

F1 Measure more points

To return to the **Enter Target Point** screen to measure more points.

F2 Measure in other face

To measure the same target point in another face.

F3 Access Tolerances

To change the accuracy limit values.

F4 Compute

To calculate and display the station coordinates.

Description of symbols

Field	Description
✓	Standard deviation/value within the defined limit
x	Standard deviation/value exceeds the defined limit
---	No value calculated

Description of fields

Field	Description
Accur. Posit.	If the standard deviation for position in East and North is calculated, a checkbox is displayed. The checkbox is checked if the calculated position is within the standard deviation limits or crossed if it is not.
Accur. Height	If the standard deviation for Height is calculated, a checkbox is displayed. The checkbox is checked if the calculated Height is within the standard deviation limits or crossed if it is not.
Accur. Hz	If the standard deviation for the Hz Orientation angle is calculated, a checkbox is displayed. The checkbox is checked if the calculated Hz Orientation is within the standard deviation limits or crossed if it is not.

Computation procedure

The computation of the station position is done via the **Method** selected in **Enter Station Data**.

If more than the minimum required measurements are performed, the procedure uses a least squares adjustment to determine the 3D position and averages orientation and height measurements.

- The original averaged face I and face II measurements are used for the computation process.
- All measurements are treated with the same accuracy, whether these are measured in single or dual face.
- Easting and Northing are determined by the least squares method, which includes standard deviation and improvements for horizontal direction and horizontal distances.
- The final height (**H**) is computed from averaged height differences based on the original measurements. For the methods **Ori. with Coord.** and **H-Trans** the height can be selected from old, average and new.
- The horizontal direction is computed with the original averaged face I and face II measurements and the final computed plan position.

Access

Press **F4 Compute** in the **Station Setup Result** screen.

Station Setup Result

This screen displays calculated station coordinates. The final computed results depend on the **Method** selected in **Enter Station Data**. Standard deviations and residuals for accuracy assessments are provided.

Setup Result 1/2		➔
Result1	Result2	
Station:		222
hi :	1.400	m
East :	0.000	m
North :	0.000	m
Height :	0.000	m <input checked="" type="checkbox"/>
Hz :	200.0240	g <input checked="" type="checkbox"/>
Δ  :	-----	m
Add Pt Resid. Std. Dev Set		

Add Pt

To return to the **Enter Target Point** screen to enter the next point.

Resid.

To display residuals and to define the use of points as 1D, 2D or 3D. Refer to "Target Residuals".

Std.Dev

To display the standard deviation of the station coordinates and orientation.

Set

To set the station coordinates and/or orientation.



If the instrument height was set to 0.000 in the setup screen, then the station height refers to the height of the tilting axis.

Description of fields

Field	Description
Station	Current station ID.
hi	Current instrument height.
East	Calculated Easting coordinate of the station.
North	Calculated Northing coordinate of the station.
Height	Calculated Height coordinate of the station.
Hz	Current Hz angle with the new orientation.
Δ 	Available for Method: H-Trans or Ori. with Coord. with only 1 target point. Difference between the calculated and measured horizontal distance from the station to the design target.

Field	Description
Scale	Available for Method: Resection and Method: Res.Helm.. The calculated scale, if available.
Apply Scale	Yes or No . Select Yes to use the calculated scale as the system PPM scale. This overwrites any PPM scale previously set in the EDM Settings screens. Select No to keep the existing PPM value in the system and not apply the calculated scale.

Target Residuals

The **Target Residuals** screen displays the computed residuals for the horizontal and vertical distances and the horizontal direction. Residual = Calculated value - Measured value.

Use indicates if and how a target point is used in the station calculation. Choices are **3D**, **2D**, **1D** and **Off**.

Description of fields

Field	Description
3D	Easting, Northing and Height coordinates are used for the calculation.
2D	Easting and Northing coordinates are used for the calculation.
1D	Only the height of the point is used for the calculation.
Off	The point is not used for the calculation.

Messages

The following are important messages or warnings that may appear.

Messages	Description
Selected point has invalid data! Check data and try again!	This message occurs if the selected target point has no Easting or Northing coordinate.
Max. 10 points supported!	10 points have already been measured and another point is selected. The system supports a maximum of 10 points.
No position computed due to bad data!	The measurements may not allow final station coordinates (Eastings, Northings) to be computed.
No height computed due to bad data!	Either the target height is invalid or insufficient measurements are available to compute a final station height.
Face I/II mismatch!	This error occurs if a point was measured in one face and the measurement in the other face differs by more than the specified accuracy limit for the horizontal or vertical angle.
No data measured! Measure point again!	There is insufficient data measured to be able to compute a position or height. Either there are not enough points used or no distance measured.

Next step

Press **Set** to set the station coordinates and/or orientation and return to the **Programs** Menu.



- If a target point is measured several times in the same face, only the last valid measurement is used for computation.
- For **Method: Resection**:
 - The prism used for face I and face II measurements must be the same.
 - If different codes for face I and II are used, then the code of face I is used. If only face II is measured with a code, then the code of face II is assigned to the point.

- XML output does not allow a change of the ppm value during **Stn.Setup** measurements.
- If the scale is calculated, then the standard deviation of the position with two targets is 0.0000. With flexible scale, the resection is fitted perfectly into the geometry without redundancy. Therefore the standard deviation is 0.000.



6.3

Surveying

Description

Survey is a program used for the measurement of an unlimited number of points. It is comparable to **Q-Survey** from the Main Menu, but includes pre-settings for the job, station and orientation prior to beginning a survey.

Access

1. Select  **Programs** from the Main Menu.
2. Select  **Survey** from the **Programs** Menu.
3. Complete program pre-settings. Refer to "5 Programs - Getting Started".

Survey

Survey		Coord.	Code
Polar 1	Polar 2		
PtID	:		447
hr	:	1.500 m	
Remark	:		552
Hz	:	200.0360 g	
V	:	111.0000 g	
	:	9.851 m	
	:	10.000 m	
Meas		Dist	Store
			↓

↓ Q-Code

To activate quick coding. Refer to "8.2 Quick Coding".

↓ IndivPt

To switch between individual and current point numbers.

↓ Manage

To view measurement data.

Description

Stakeout is a program used to place marks in the field at predetermined points. These predetermined points are the points to be staked. The points to be staked may already exist in a job on the instrument, or be manually entered. The program can continuously display differences, between current position and desired stake out position.

Stakeout modes

Points can be staked using different modes: Polar mode, Orthogonal to station mode and Cartesian mode.

Polar Stakeout mode

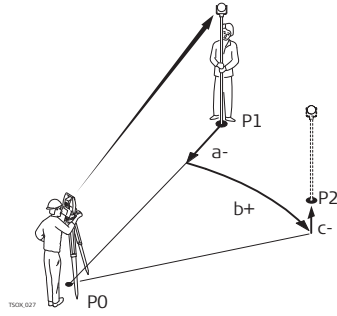

- P0 Instrument station
- P1 Current position
- P2 Point to be staked
- a- Δ : Difference in horizontal distance
- b+ Δ Hz: Difference in direction
- c+ Δ : Difference in height

Orthogonal to Station Stakeout mode

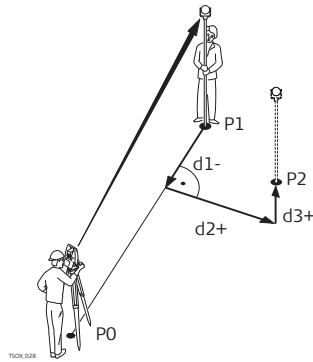

- P0 Instrument station
- P1 Current position
- P2 Point to be staked
- d1- Δ Length: Difference in longitudinal distance
- d2+ Δ Trav.: Difference in perpendicular distance
- d3+ Δ Height: Difference in height

Cartesian Stakeout mode

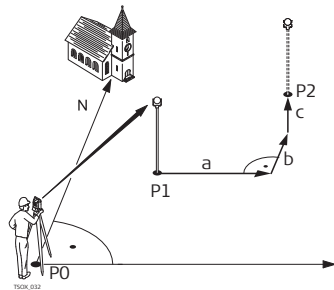



- P0 Instrument station
- P1 Current position
- P2 Point to be staked
- a Δ East: Difference in Easting coordinate
- b Δ North: Difference in Northing coordinate
- c Δ Height: Difference in height

Access

1. Select **Programs** from the Main Menu.
2. Select **Stakeout** from the **Programs** Menu.
3. Complete program pre-settings. Refer to "5 Programs - Getting Started".

Stakeout Settings

Field	Description
Pre-/Suffix	 Only used for the Stakeout program.
	Prefix Adds the character entered for Identifier in front of the original point number of the point to be staked.
	Suffix Adds the character entered for Identifier at the end of the original point number of the point to be staked.
	Off The staked point is stored with the same point number as the point to be staked.
Identifier	 Only used for the Stakeout program. The identifier can be up to four characters and is added at the start, or end, of a point number of a point to be staked.
Stakeout Beep	On The instrument beeps when the distance from the current position to the point to be staked is ≤ 0.5 m. The closer the prism is to the point to be staked the faster the beeps will be.
	Off Beep is deactivated.

Stakeout

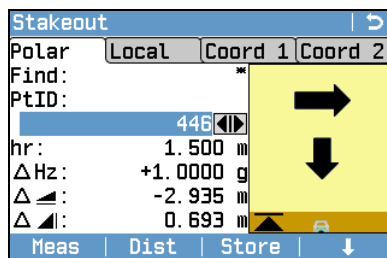

↓ B&Dist

To enter the direction and horizontal distance to a stake out point.

↓ Manual

To manually enter coordinates of a point.

↓ Survey

To switch to the Survey program. Press ESC to return to the **Stakeout** screen..

 Refer to "2.7 Graphic Symbols" for a description of the graphic elements.

Field	Description
Find	Value for Point ID search. After entry, the firmware searches for matching points, and displays these in PtID : If a matching point doesn't exist the pointsearch screen opens.
Pt Type/ID:	Displays the type of point selected. <ul style="list-style-type: none"> • Fixpt., or • Meas.
ΔHz	Angle offset: Positive if stake out point is to the right of the measured point.
Δ_h	Horizontal offset: Positive if stake out point is further away than the measured point.
Δ_l	Height offset: Positive if stake out point is higher than the measured point.
ΔL	Longitudinal offset: Positive if stake out point is further away than the measured point.
ΔT	Perpendicular offset: Positive if stake out point is to the right of the measured point.
ΔH	Height offset: Positive if stake out point is higher than the measured point.
ΔE	Easting offset: Positive if stake out point is to the right of the measured point.
ΔN	Northing offset: Positive if stake out point is further away than the measured point

6.5

Reference Line

6.5.1



Overview

Description

Reference Line is a program that facilitates the easy stake out or checking of lines, for example, for buildings, sections of road, or simple excavations. It allows the user to define a reference line and then complete the following tasks with respect to that line:

- Line & offset
- Stake out points
- Grid stake out
- Line segmentation stake out

Access

1. Select  **Programs** from the Main Menu.
2. Select  **Ref.Line** from the **Programs** Menu.
3. Complete program pre-settings. Refer to "5 Programs - Getting Started".

Next step

Define the base line for the reference line.

6.5.2

Defining the Base Line

Description

A reference line can be defined by referencing a known base line. The reference line can be offset either longitudinally, in parallel or vertically to the base line, or be rotated around the first base point as required. Furthermore the reference height can be selected as the first point, second point or interpolated along the reference line.

Define the base line

The base line is fixed by two base points. All points can be either measured, manually entered, or selected from the memory.

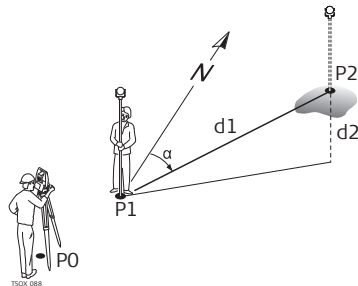

Base line

P0 Instrument station

P1 Start point

P2 End point

d1 Known distance

d2 Difference in height

α Azimuth

Define the base line by measuring or selecting the start and end points of the line.

Next step

After defining the base line the **Reference Line - Info** screen will appear for defining the reference line.

Description

The base line can be offset from, either longitudinally, in parallel or vertically, or be rotated around the first base point. This new line created from the offsets is called the reference line. All measured data refers to the reference line.

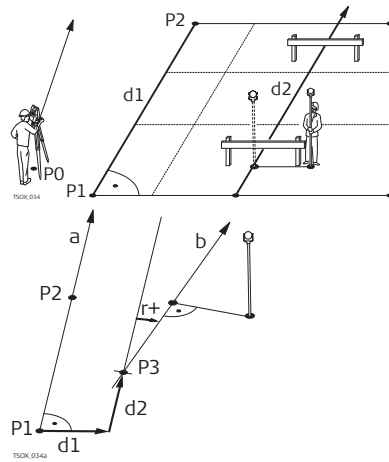

- P0 Instrument station
- P1 Start point
- P2 End point
- d1 Base line
- d2 Reference line
- P1 Base point
- P2 Base point
- a Base line
- d1 Parallel offset
- d2 Longitudinal offset
- P3 Reference point
- r+ Rotation parameter
- b Reference line

Access

After completing the measurements required for defining the base line, the **Reference Line - Info** screen will appear.

Reference Line - Info

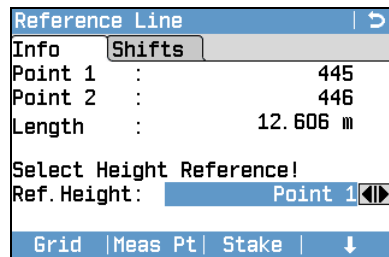

Grid

To stake out a grid relative to the reference line.

Meas Pt

To measure Line & Offset.

Stake

To stake out points orthogonal to the reference line.

↓ NewBL

To define a new base line.

↓ Shift=0

To reset all offset values to 0.

↓ Segment

To subdivide a reference line into a definable number of segments and stake out the new points on the reference line.

Field	Description
Length	Length of the base line.
Ref. Height	Point 1 Height differences are computed relative to the height of the first reference point.
	Point 2 Height differences are computed relative to the height of the second reference point.
	Interpolated Height differences are computed along the reference line.
	No Height Height differences are not computed or shown.
Offset	Parallel offset of the reference line relative to the base line (P1-P2). Available on page 2/2 for Black&White display or on page Shifts for Color&Touch display. Positive values are to the right of the base line.

Field	Description
Line	Longitudinal offset of the start point, reference point (P3), of the reference line in the direction of base point 2. Available on page 2/2 for Black&White display or on page Shifts for Color&Touch display. Positive values are towards base point 2.
Height	Height offset of the reference line to the selected reference height. Available on page 2/2 for Black&White display or on page Shifts for Color&Touch display. Positive values are higher than the selected reference height.
Rotate	Rotation of the reference line clockwise around the reference point (P3). Available on page 2/2 for Black&White display or on page Shifts for Color&Touch display.

Next step

Select a softkey option, **Meas Pt**, **Stake**, **Grid** or **↓ Segment**, to proceed to a subprogram.

6.5.4

Measure Line & Offset

Description

The Measure Line & Offset subprogram calculates from measurements or coordinates, longitudinal offsets, parallel offsets and height differences of the target point relative to the reference line.



- P0 Instrument station
- P1 Start point
- P2 End point
- P3 Measured point
- P4 Reference point
- d1 Δ Offset
- d2 Δ Line

Example of height difference relative to first reference point

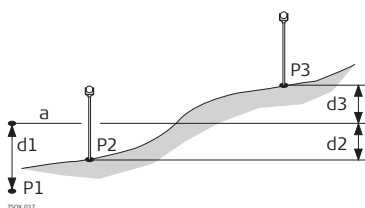

- P1 Start point
- P2 Target point
- P3 Target point
- a Reference height
- d1 Height difference between start point and the reference height
- d2 Height difference between P2 and the reference height
- d3 Height difference between P3 and the reference height

Access

Press **Meas** in the **Reference Line - Info** screen.

Measure line & offset

Field	Description
ΔL	Calculated distance longitudinal to the reference line.
ΔO	Calculated distance perpendicular from the reference line.
ΔH	Calculated height difference relative to the defined reference height.

Next step

- Either, press **Meas** to measure and record.
- Or, press **↓ Back** to return to the **Reference Line - Info** screen.

Description

The stakeout subprogram calculates the difference between a measured point and the calculated point. The orthogonal (ΔL , ΔO , ΔH) and polar (ΔHz , $\Delta \sphericalangle$, $\Delta \sphericalangle$) differences are displayed.

Example orthogonal stakeout

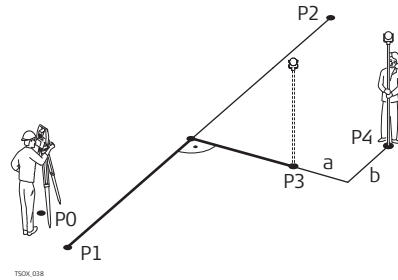

- P0 Instrument station
- P1 Start point
- P2 End point
- P3 Stake out point
- P4 Measured point
- a Δ Parallel offset
- b Δ Longitudinal offset

Access

Press **Stake** from the **Reference Line - Info** screen.

Orthogonal stakeout

Enter the stake out elements for the target points to be staked out relative to the reference line.

Field	Description
Line	Longitudinal offset: Positive if stake out point is further away from the reference line.
Offs	Perpendicular offset: Positive if stake out point is to the right of the reference line.
Height	Height offset: Positive if stake out point is higher than the reference line.

Next step

Press **Cont** to proceed to measurement mode.

Reference Line - Stakeout

The signs for the distance and angle differences are correction values (required minus actual). The arrows indicate the direction to move to get to the stake out point.

To allow a better visibility, for example if the line is very long and the target close to the line, the scale for x and y can be different in the graphic. If the instrument is far off the line, the instrument in the graphic is placed in the corner and marked red/grey.

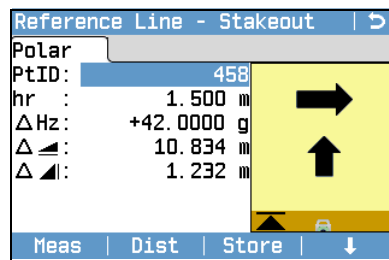

Next Pt

To add the next point to be staked out.

Field	Description
ΔHz	Horizontal direction from the measured point to the stake out point. Positive if the telescope must be turned clockwise to the stake out point.
$\Delta \sphericalangle$	Horizontal distance from the measured point to the stake out point. Positive if the stake out point is further away than the measured point.
$\Delta \sphericalangle$	Height difference from the measured point to the stake out point. Positive if the stake out point is higher than the measured point.

Next step

- Either, press **Meas** to measure and record.
- Or, press **↓ Back** to return to the **Reference Line - Info** screen.

Description

The Grid subprogram calculates and displays the stake out elements for the points on the grid, orthogonal (ΔL , ΔO , ΔH) and polar (ΔHz , $\Delta \angle$, $\Delta \angle$). The grid is defined without boundaries. It can be extended over the first and second base points of the reference line.

Example Grid Stakeout

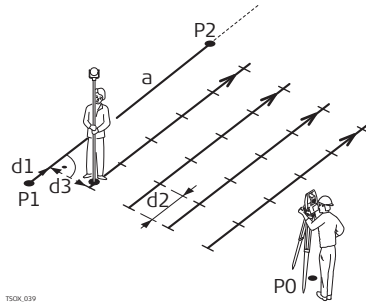

- a Reference line
- P0 Instrument station
- P1 Start point
- P2 End point
- d1 Start distance
- d2 Increment
- d3 Line offset

Access

Press **Grid** from the **Reference Line - Info** screen.

Grid definition

Enter the chainage and the increment of grid points in length and cross direction of the reference line.

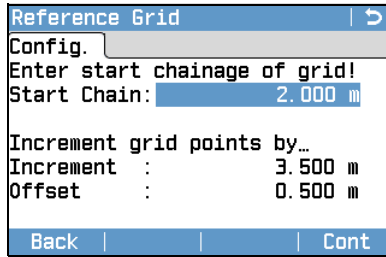

Field	Description
Start Chain	Distance from the reference line start point to the beginning grid start point.
Increment	Length of incrementation.
Offset	Offset distance from the reference line.

Next step

Press **Cont** to proceed to the **Reference Grid - Stakeout** screen.

Reference Grid - Stakeout

The signs for the distance and angle differences are correction values (required minus actual). The arrows indicate the direction to move to get to the stake out point.

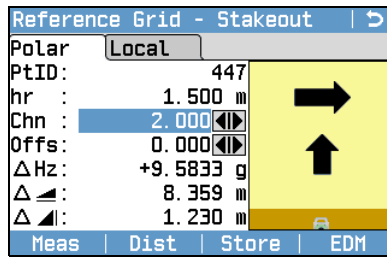

Field	Description
Chn	The chainage of the grid stakeout point.
Offs	Offset increment values. The stake out point is to the right of the reference line.
ΔHz	Horizontal direction from the measured point to stake out point. Positive if the telescope must be turned clockwise to the stake out point.
Δ (horizontal distance)	Horizontal distance from the measured point to stake out point. Positive if the stake out point is further away than the measured point.
Δ (height difference)	Height difference from the measured point to the stake out point. Positive if the stake out point is higher than the measured point.
Line	Grid increment values. The stake out point is in the direction from the first to the second reference point.
ΔL	Longitudinal distance from the measured point to the stake out point. Positive if stake out point is further away than the measured point.
ΔO	Perpendicular distance from the measured point to the stake out point. Positive if stake out point is to the right of the measured point.

Next step

- Either, press **Meas** to measure and record.
- Or, press ESC to return to the **Enter start chainage of grid!** screen and from there, press **Back** to return to the **Reference Line - Info** screen.

Description

The line segmentation subprogram calculates and displays the stake out elements for the points along the line, orthogonal (ΔL , ΔO , ΔH) and polar (ΔHz , $\Delta \angle$, $\Delta \angle$). Line Segmentation is limited to the reference line, between the defined start and end points of the line.

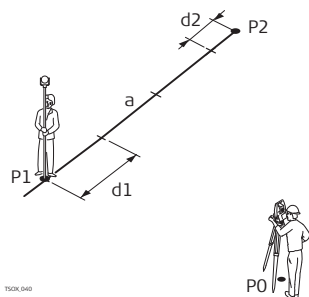
Example Line Segmentation Stakeout

- P0 Instrument station
- P1 First reference point
- P2 Second reference point
- a Reference line
- d1 Segment length
- d2 Misclosure

Access

Press **↓ Segment** from the **Reference Line - Info** screen.

Segment Definition

Enter either the number of segments, or the length of segments and define how the remaining line length is treated. This misclosure can be placed at the start, at the end, at the start and the end or distributed evenly along the line.

Line Segment	
Config.	>
Define Line Segment	
Line Length :	12.606 m
Segment Length:	3.500 m
Segment No. :	4
Misclosure :	2.106 m
Distrib. :	None
Back	Cont

Field	Description
Line Length	Calculated length of the defined reference line.
Segment Length	Length of each segment. Updated automatically if the number of segments is entered.
Segment No.	Number of segments. Updated automatically if the segment length is entered.
Misclosure	Any remaining line length after segment length has been entered.
Distrib.	Method of misclosure distribution. <ul style="list-style-type: none"> None All of the misclosure will be placed after the last segment. At start All of the misclosure will be placed before the first segment. Equal The misclosure will be equally distributed between all segments. StartEnd The misclosure is equally distributed at the start and at the end of the segment line.

Next step

Press **Cont** to proceed to the **Line Segment - Stakeout** screen.

Line Segment - Stakeout

The signs for the distance and angle differences are correction values (required minus actual). The arrows indicate the direction to move to get to the stake out point.

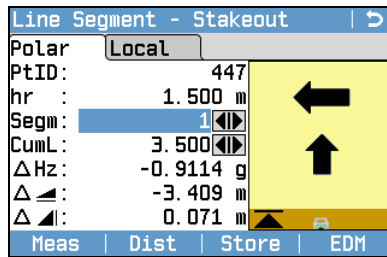

Field	Description
Segm	Segment number. Includes the misclosure segment, if applicable.
CumL	Cumulation of the segment lengths. Changes with the current number of segments. Includes the misclosure segment length if applicable.
ΔHz	Horizontal direction from the measured point to the stake out point. Positive if the telescope must be turned clockwise to the stake out point.
Δ	Horizontal distance from the measured point to the stake out point. Positive if the stake out point is further away than the measured point.
Δ	Height difference from the measured point to the stake out point. Positive if the stake out point is higher than the measured point.
ΔL	Longitudinal distance from the measured point to the stake out point. Positive if stake out point is further away than the measured point.
ΔL	Perpendicular distance from the measured point to the stake out point. Positive if stake out point is to the right of the measured point.

Messages

The following are important messages or warnings that may appear.

Messages	Description
Baseline too short!	Base line is shorter than 1 cm. Choose base points such that the horizontal separation of both points is at least 1 cm.
Coordinates invalid!	No coordinates or invalid coordinates for a point. Ensure that points used have at least Easting and Northing coordinates.
Recording to inter- face!	Data Output is set to Interface in the Data Settings Menu. To be able to successfully start reference line, Data Output must be set to Internal Memory .

Next step

- Either, press **Meas** to measure and record.
- Or, press ESC to return to the **Define Line Segment** screen and from there, press **Back** to return to the **Reference Line** screen.
- Or, continue selecting ESC to exit the program.

6.6

Reference Arc

6.6.1



Overview

Description

The Reference Arc program allows the user to define a reference arc and then complete the following tasks with respect to the arc:

- Line & offset
- Stakeout (Point, Arc, Chord, Angle)

Access

1. Select  **Programs** from the Main Menu.
2. Select  **Ref.Arc** from the **Programs** Menu.
3. Complete program pre-settings. Refer to "5 Programs - Getting Started".

Next step

Define the reference arc.

6.6.2

Defining the Reference Arc

Description

The reference arc can be defined by;

- a center point and start point,
- a start point, end point, and radius, or
- by three points.

All points can be either measured, manually entered, or selected from the memory.

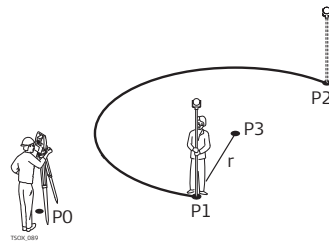

Reference arc

P0 Instrument station

P1 Start point

P2 End point

P3 Center point

r Radius of arc



All arcs are defined in a clockwise direction and all calculations are made in two dimensions.

Access

Select  **Ref.Arc** and then the method to define the arc by:

- **F1 Centre,Start Point**
- **F2 Start & End Pt,Radius**
- **F3 3 Points**

Reference Arc - Measure to start point

Field	Description
Start Pt	Point ID of the start point.
Centre Pt	Point ID of the center point.
Mid Pt	Point ID of the mid point.
End Pt	Point ID of the end point.
Radius	Radius of the arc.

Next step

After defining the reference arc the **Reference Arc - Info** screen will appear.

Reference Arc - Info

Reference Arc	
Info	
Start Pt :	444
Mid Pt :	-----
End Pt :	446
Center Pt :	-----
Radius :	8.089 m
Arc Length 1:	21.922 m
Arc Length 2:	28.902 m
New Arc	Cont

In certain cases, there are two mathematical solutions, as shown in the screenshot. In the subprograms Measure and Stakeout, the appropriate solution can be selected.

Next step

Select **Cont** and then **Meas Pt** or **Stake** to proceed to a subprogram.

6.6.3

Measure Line & Offset

Description

The Measure Line & Offset subprogram calculates from measurements or coordinates, longitudinal and orthogonal offsets and height differences of the target point relative to the reference arc.

Example reference arc - measure line & offset

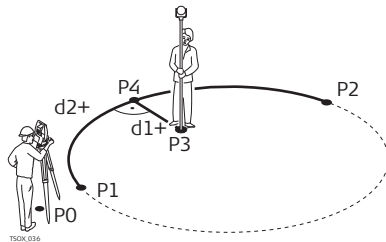

- P0 Instrument station
- P1 Start point
- P2 End point
- P3 Measured point
- P4 Reference point
- d1+ Δ Offset
- d2+ Δ Line

Access

Press **Meas** from the **Reference Arc - Info** screen.

Measure Line & Offset

Field	Description
ΔL	Calculated distance longitudinal to the reference arc.
ΔO	Calculated distance perpendicular from the reference arc.
ΔH	Calculated height difference relative to the start point of reference arc.

Next step

- Either, press **Meas** to measure and record.
- Or, press **Back** to return to the **Reference Arc - Info** screen.

Description

The Stakeout subapplication calculates the difference between a measured point and the calculated point. The Reference Arc program supports four ways to stake out:

- Stake out point
- Stake out chord
- Stake out arc
- Stake out angle

Stake out point

To stake out a point by entering a line and an offset value.

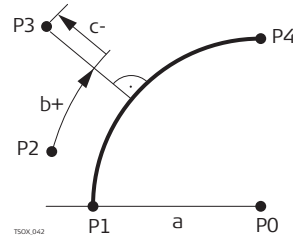

- P0 Center point of arc
- P1 Start point of arc
- P2 Measured point
- P3 Stake out point
- P4 End point of arc
- a Radius of arc
- b+ Line offset
- c- Perpendicular offset

Stake out arc

To stake out a series of equidistant points along the arc.

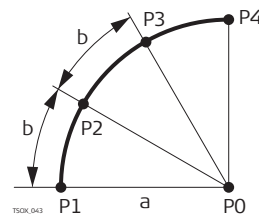

- P0 Center point of arc
- P1 Start point of arc
- P2 Stake out point
- P3 Stake out point
- P4 End point of arc
- a Radius of arc
- b Arc length

Stake out chord

To stake out a series of equidistant chords along the arc.

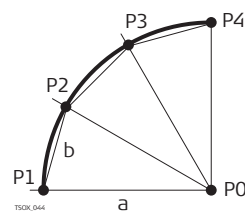

- P0 Center point of arc
- P1 Start point of arc
- P2 Stake out point
- P3 Stake out point
- P4 End point of arc
- a Radius of arc
- b Chord length

Stake out angle

To stake out a series of points along the arc defined by the angle segments from the center point of the arc.

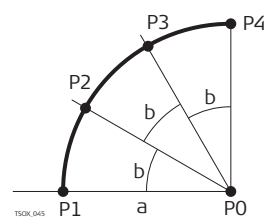

- P0 Center point of arc
- P1 Start point of arc
- P2 Stake out point
- P3 Stake out point
- P4 End point of arc
- a Radius of arc
- b Angle

Access

- 1) Press **Stake** from the **Reference Arc - Info** screen.
- 2) Select one of the four methods of stake out available.

Stake out point, arc, chord or angle

Enter the stake out values. Press **CentreP** to stake the arc centre point.

Field	Description
Line	For stake out arc, chord and angle: Longitudinal offset from the reference arc. This is calculated by the arc length, chord length or angle and the selected misclosure distribution. For stake out point: Longitudinal offset from the reference arc.
Offset	Perpendicular offset from the reference arc.
Distrib.	For stakeout arc: Method of misclosure distribution. If the entered arc length is not an integer of the whole arc, there will be a misclosure. None All of the misclosure will be added to the last arc-section. Equal The misclosure will be equally distributed between all sections. Start Arc All of the misclosure will be added to the first arc-section. Start & End The misclosure will be added half to the first arc-section and half to the last arc-section.
Arc Length	For stakeout arc: The length of the arc-segment to stake out.
Chord Length	For stakeout chord: The length of the chord to stake out.
Angle	For stake out angle: The angle around the center point of the arc, of the points to be staked out.

Next step

Press **Cont** to proceed to measurement mode.



Reference Arc - Stakeout

The signs for the distance and angle differences are correction values (required minus actual). The arrows indicate the direction to move to get to the stake out point.

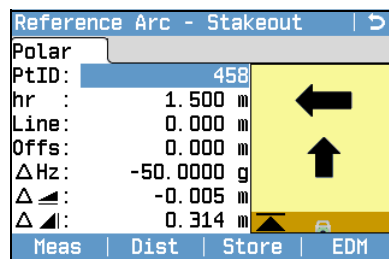
 To allow a better visibility, for example if the arc is very long and the target close to the line, the scale for x and y can be different in the graphic. If the instrument is far off the arc, the instrument in the graphic is placed in the corner and marked red/grey.



To define the next point to be staked out, type in a point ID, the reflector height, the distance along the arc and an offset.

Field	Description
ΔHz	Horizontal direction from the measured point to the stake out point. Positive if the telescope must be turned clockwise to the stake out point.
Δ 	Horizontal distance from the measured point to the stake out point. Positive if the stake out point is further away than the measured point.
Δ 	Height difference from the measured point to the stake out point. Positive if the stake out point is higher than the measured point.

Next step

- Either, press **↓ Meas** to measure and record.
- Or, press **↓ Back** to return to the **Reference Arc - Info** screen.
- Or, continue selecting **ESC** to exit the program.

Description

Reference Plane is a program used to measure points relative to a reference plane. It can be used for the following tasks:

- Measuring a point to calculate and store the perpendicular offset to the plane.
- Calculating the perpendicular distance from the intersection point to the local X- and Z-axis. The intersection point is the footprint point of the perpendicular vector from the measured point through the defined plane.
- Viewing, storing and staking out the coordinates of the intersection point.

A reference plane is created by measuring three points on a plane. These three points define a local coordinate system:

- The first point is the origin of a local coordinate system.
- The second point defines the direction of the local Z-axis.
- The third point defines the plane.

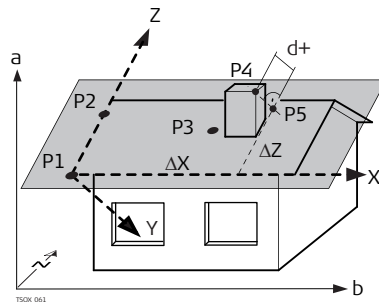

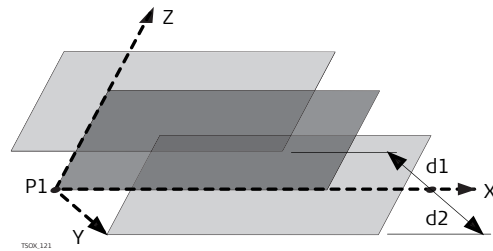

- X X-axis of local coordinate system.
- Y Y-axis of local coordinate system.
- Z Z-axis of local coordinate system.
- P1 First point, origin of local coordinate system.
- P2 Second point
- P3 Third point
- P4 Measured point. This point is probably not located on the plane.
- P5 Intersection point of the perpendicular vector from P4 to the defined plane. This point is definitely located on the defined plane.
- d+ Perpendicular distance from P4 to the plane.
- ΔX Perpendicular distance from P5 to the local Z-axis.
- ΔZ Perpendicular distance from P5 to the local X-axis.

The perpendicular distance to the plane can be positive or negative.



- P1 Origin of plane
- X X-axis of plane
- Y Y-axis of plane
- Z Z-axis of plane
- d1 Positive offset
- d2 Negative offset

Access

1. Select  **Programs** from the Main Menu.
2. Select  **Ref.Plane** from the **Programs** Menu.
3. Complete program pre-settings. Refer to "5 Programs - Getting Started".

Measure plane and target points

1. Once the plane has been defined by three points, the **Measure target point!** screen appears.
2. Measure and record the target point. The results are displayed in the **Reference Plane Result** screen.

Reference Plane Result

Reference Plane Result	
Result	
Int. PtID:	441
Offset:	4.779 m
ΔX :	-13.979 m
ΔZ :	28.748 m
East :	34.832 m
North :	9.664 m
Height:	21.441 m
NewTgt Stake NewPlan Quit	

NewTgt

To record and save the intersection point and to proceed to measure a new target point.

Stake

To display stake out values and a graphic for the intersection point. Refer to "2.7 Graphic Symbols" for an explanation of the graphic symbols.

NewPlan

To define a new reference plane.

Field	Description
Int.PtID	Point ID of the intersection point, the perpendicular projection of the target point on the plane.
Offset	Calculated perpendicular distance between target point and plane (intersection point).
ΔX	Perpendicular distance from the intersection point to the local Z-axis.
ΔZ	Perpendicular distance from the intersection point to the local X-axis.
East	Easting coordinate of the intersection point.
North	Northing coordinate of the intersection point.
Height	Height of the intersection point.

6.8

Tie Distance

Description

Tie Distance is a program used to compute slope distance, horizontal distance, height difference and azimuth of two target points which are either measured, selected from the memory, or entered using the keypad.

Tie distance methods

The user can choose between two different methods:

- **F1 Polygonal:** P1-P2, P2-P3, P3-P4.
- **F2 Radial:** P1-P2, P1-P3, P1-P4.

Polygonal method

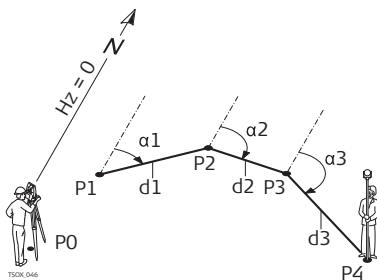

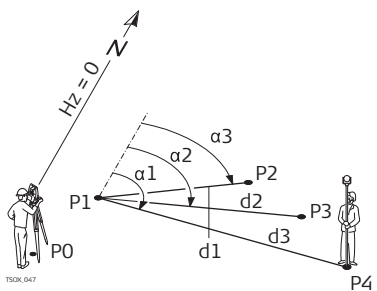

- P0 Instrument station
- P1-P4 Target points
- d1 Distance from P1-P2
- d2 Distance from P2-P3
- d3 Distance from P3-P4
- α_1 Azimuth from P1-P2
- α_2 Azimuth from P2-P3
- α_3 Azimuth from P3-P4

Radial method



- P0 Instrument station
- P1-P4 Target points
- d1 Distance from P1-P2
- d2 Distance from P1-P3
- d3 Distance from P1-P4
- α_1 Azimuth from P1-P4
- α_2 Azimuth from P1-P3
- α_3 Azimuth from P1-P2

Access

1. Select  **Programs** from the Main Menu.
2. Select  **Tie Dist.** from the **Programs** Menu.
3. Complete program pre-settings. Refer to "5 Programs - Getting Started".
4. Select **F1 Polygonal** or **F2 Radial**.

Tie distance measurements

After completing the measurements required, the **Tie Distance Result** screen will appear.

Tie Distance Result - Polygonal method

Tie Distance Result		>
Result		
Point 1:		444
Point 2:		446
Bearing:		300.0000 g
Grade :	1.000:	0.000 h:v
Δ ↘ :		15.803 m
Δ ↙ :		15.803 m
Δ ↕ :		0.000 m
NewPt 1 NewPt 2		Radial

NewPt 1

To calculate an additional line. The program starts again at point 1.

NewPt 2

To set point 2 as the starting point of a new line. A new point 2 must be measured.

Radial

To switch to radial method.

Field	Description
Bearing	Azimuth between point 1 and point 2.
Grade	Grade between point 1 and point 2.
Δ ↘	Slope distance between point 1 and point 2.
Δ ↙	Horizontal distance between point 1 and point 2.
Δ ↕	Height difference between point 1 and point 2.

Next step

Press ESC to exit the program.

Description

Area & DTM Volume is a program used to compute online areas to a maximum of 50 points connected by straights. The target points have to be measured, selected from memory, or entered via the keypad in a clockwise direction. The calculated area is projected onto the horizontal plane (2D) or projected onto the sloped reference plane defined by three points (3D). Furthermore a volume can be computed by automatically creating a digital terrain model (DTM).

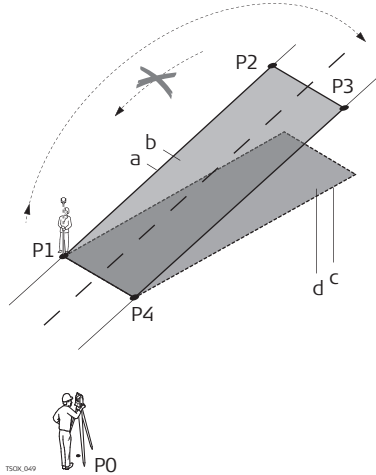

- P0 Instrument station
- P1 Target point which defines the sloped reference plane
- P2 Target point which defines the sloped reference plane
- P3 Target point which defines the sloped reference plane
- P4 Target point
- a Perimeter (3D), polygonal length from the start point to the current measured point of the area (3D)
- b Area (3D), projected onto the sloped reference plane
- c Perimeter (2D), polygonal length from the start point to the current measured point of the area (2D)
- d Area (2D), projected onto the horizontal plane

Access

1. Select **Programs** from the Main Menu.
2. Select **Area&Vol.** from the **Programs** Menu.
3. Complete program pre-settings. Refer to "5 Programs - Getting Started".

Area & DTM Volume

The graphic always shows the area projected onto the reference plane. The points used for defining the reference plane are indicated by:

- ◦ for measured points.
- ▲ for manually entered points.
- □ for points defining the reference plane.

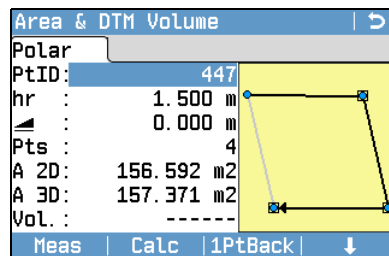

Calc

To display and record additional results (perimeter, volume).

1PtBack

To undo measurement or selection of the previous point.

↓ Volume

To measure or select points on the breakline. These points are then used to calculate a volume.

↓ Def. 3D

To manually define the sloped reference plane by selecting or measuring three points.



The breakline points must be located within the boundary of the defined area.

Area calculation

The 2D and 3D areas are calculated automatically and displayed once three points have been measured or selected. The 3D area is calculated automatically based on the following;

- The system will use the three points which cover the largest area.
- If there are two or more equal largest areas, the system will use the area with the shortest perimeter.
- If the largest areas have equal perimeters, the system will use the area with the last measured point.

A reference plane for the 3D area calculation can be manually defined by selecting **Def. 3D**.

Graphical representation

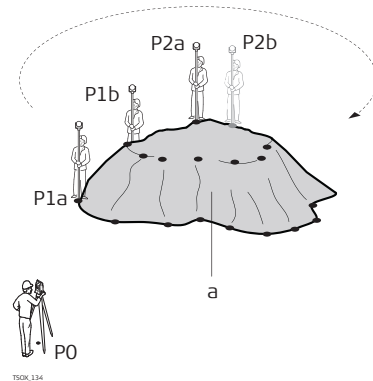

- P0 Instrument station
- P1a.. Boundary point
- P2a.. Breakline point
- a Volume as calculated by the triangulated irregular network (TIN)

Next step

Press **Calc** to calculate area and volume and proceed to the **2D-Area & DTM-Volume Result / 3D-Area & DTM-Volume Result** screens.

2D-Area & DTM-Volume Result

2D-Area & DTM-Volume Result			Calculate Volume & Weight		
2D	3D	Volume	2D	3D	Volume
Pts :		8	DTM-Grd. Area :		157.710 m ²
Area :	0.016 ha		BreakLn Area :		39.308 m ²
Area :	156.592 m ²		DTM-Volume I :		52.245 m ³
Per. :	50.695 m		Swell Factor :		1.200
DTM-V :	52.245 m ³		DTM-Volume II :		62.694 m ³
			Weight Factor :		1.250 t/m ³
			Weight :		78.368 t

Field	Description
Area (2D)	Area calculated by projection onto a horizontal plane.
Area (3D)	Area calculated by projection onto an automatically or manually defined reference plane.
DTM-Grd.Area	Area defined by ground points, calculated by triangulated irregular network (TIN).
BreakLn Area	Area defined by breakline points, calculated by TIN.
DTM-Volume I	Volume as calculated by TIN.
Swell Factor	Factor that gives the relationship between the volume of a material as found in nature, to the volume of the same material after excavation. Refer to the table "Swell Factor" for more information on swell factors.
DTM-Volume II	Volume of the material after excavation from its original location. DTM-Volume II = DTM-Volume I x Swell Factor.
Weight Factor	Weight in tons per m ³ of material. Editable field.
Weight	Total weight of material after being excavated. Weight = DTM-Volume II x Weight Factor.

Swell Factor

According to DIN18300, the following soil classes have the given swell factors.

Soil class	Description	Swell Factor
1	Topsoil containing unorganic material, as well as humus or organic animals.	1.10 - 1.37
2	Fluent soil types of fluid to semi-fluid consistency.	n/a
3	Easily degradable soil types. Cohesionless to hardly cohesive sands.	1.06 - 1.32
4	Moderately degradable soil types. Mixture of sand, silt and clay.	1.05 - 1.45
5	Hard to degrade soil types. Same soil types as classes 3 and 4, but with a greater ratio of stones bigger than 63mm and between 0.01 m ³ to 0.1 m ³ in volume.	1.19 - 1.59
6	Rock types that have an inner mineral cohesiveness, however are fragmented, slaty, soft or weathered.	1.25 - 1.75
7	Hard to degrade rock types with a strong inner mineral cohesiveness and minimal fragmenting or weathering.	1.30 - 2.00

Swell factor examples: The values given are approximate only. Values may be different depending on various soil factors.

Soil type	Swell factor	Weight per cubic metre
Silt	1.15 - 1.25	2.1 t
Sand	1.20 - 1.40	1.5 - 1.8 t
Clay	1.20 - 1.50	2.1 t
Topsoil, humus	1.25	1.5 - 1.7 t
Sandstone	1.35 - 1.60	2.6 t
Granite	1.35 - 1.60	2.8 t

Next step

- Press **NewArea** to define a new area.
- Press **New BL** to define a new breakline area and calculate a new volume.
- Press **@BLPt** to add a new point to the existing breakline area and calculate a new volume.
- Or, press **Quit** to exit the program.

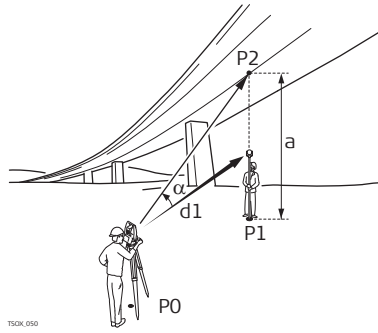

Description

Remote Height is a program used to compute points directly above the base prism without a prism at the target point.



- P0 Instrument station
- P1 Base point
- P2 Remote point
- d1 Slope distance
- a Height difference from P1 to P2
- α Vertical angle between base point and remote point

Access

1. Select  **Programs** from the Main Menu.
2. Select  **Remote Ht** from the **Programs** Menu.
3. Complete program pre-settings. Refer to "5 Programs - Getting Started".

Remote height measurement

Measure to the base point or press **hr=?** to determine an unknown target height.

Next step

After measuring, the **Aim at remote point!** screen appears.

Remote Height - Result - Aim at remote point!

Aim the instrument at the inaccessible remote point.

Field	Description
Δ 	Height difference between the base point and the remote point.
Height	Height of the remote point.
East	Calculated Easting coordinate for the remote point.
North	Calculated Northing coordinate for the remote point.
ΔEast	Calculated difference in Easting coordinate between the base point and the remote point.
ΔNorth	Calculated difference in Northing coordinate between the base point and the remote point.
ΔHeight	Calculated difference in Height between the base point and the remote point.

Next step

- Either, press **Cont** to save the measurement and record the calculated coordinates of the remote point.
- Or, press **Base** to enter and measure a new base point.
- Or, press ESC to exit the program.

6.11
6.11.1



COGO
Starting COGO

Description

COGO is a program used to perform coordinate geometry calculations such as, coordinates of points, bearings between points and distances between points. The COGO calculation methods are:

- Inverse and Traverse
- Intersections
- Offset
- Extension

Access

1. Select  **Programs** from the Main Menu.
2. Select  **COGO** from the **Programs** Menu.
3. Complete program pre-settings. Refer to "5 Programs - Getting Started".
4. Select a COGO subprogram from the **COGO** Main Menu.

Graphics

In the Results screen, press **Stake** to access the Stakeout graphic. Or, in the Results screen, change to the second page for a simple graphic. Refer to "2.7 Graphic Symbols" for a description of the graphic symbols.

6.11.2

Inverse and Traverse

Access

Select **Inverse** or **Traverse** from the **COGO** Main Menu.

Inverse

Use the **Inverse** subprogram to calculate the distance, direction, height difference and grade between two known points.

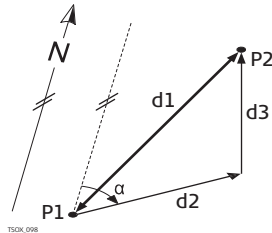

- Known
P1 First known point
P2 Second known point
Unknown
 α Direction from P1 to P2
d1 Slope distance between P1 and P2
d2 Horizontal distance between P1 and P2
d3 Height difference between P1 and P2

Traverse

Use the **Traverse** subprogram to calculate the position of a new point using the bearing and the distance from a known point. Offset optional.

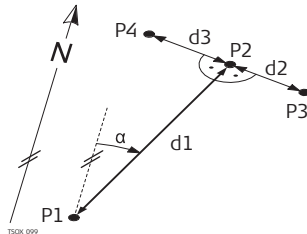

- Known
P1 Known point
 α Direction from P1 to P2
d1 Distance between P1 and P2
d2 Positive offset to the right
d3 Negative offset to the left
Unknown
P2 COGO point without offset
P3 COGO point with positive offset
P4 COGO point with negative offset

Access

Select the desired COGO subapplication from the **COGO** Main Menu:

- **Brg-Brg**
- **Brg-Dst**
- **Dst-Dst**
- **4 Point**

Bearing - Bearing

Use the **Bearing - Bearing** subprogram to calculate the intersection point of two lines. A line is defined by a point and a direction.

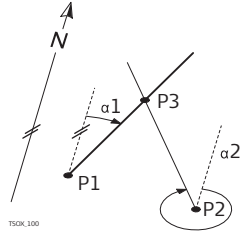

- Known
- P1 First known point
 - P2 Second known point
 - $\alpha 1$ Direction from P1 to P3
 - $\alpha 2$ Direction from P2 to P3
- Unknown
- P3 COGO point

Bearing - Bearing

Use the **Bearing - Bearing** subprogram to calculate the intersection point of a line and a circle. The line is defined by a point and a direction. The circle is defined by the center point and the radius.

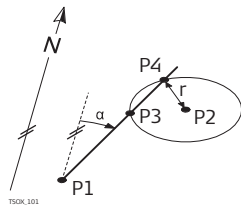

- Known
- P1 First known point
 - P2 Second known point
 - α Direction from P1 to P3 and P4
 - r Radius, as the distance from P2 to P4 or P3
- Unknown
- P3 First COGO point
 - P4 Second COGO point

Distance - Distance

Use the **Distance - Distance** subprogram to calculate the intersection point of two circles. The circles are defined by the known point as the center point and the distance from the known point to the COGO point as the radius.

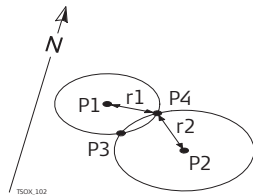

- Known
- P1 First known point
 - P2 Second known point
 - r1 Radius, as the distance from P1 to P3 or P4
 - r2 Radius, as the distance from P2 to P3 or P4
- Unknown
- P3 First COGO point
 - P4 Second COGO point

4 Point

Use the **4 Point** subprogram to calculate the intersection point of two lines. A line is defined by two points.

To add a shift for the lines, change to page 2/2 for Black&White display or page **Shifts** for Color&Touch display. + indicates a shift to the right. - indicates a shift to the left.

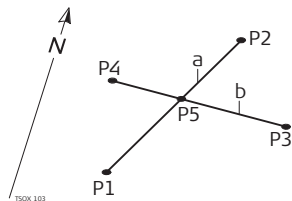

- Known
- P1 First known point
 - P2 Second known point
 - P3 Third known point
 - P4 Fourth known point
 - a Line from P1 to P2
 - b Line from P3 to P4
- Unknown
- P5 COGO point

6.11.4

Offsets

Access

Select the desired COGO subapplication from the **COGO** Main Menu:

- **DistOff**
- **Set Pt**
- **Plane**

Distance Offset

Use the **Distance Offset** subprogram to calculate the distance and offset of a known point, with the basepoint in relation to a line.

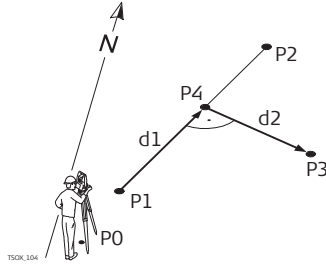

- Known
 P0 Instrument station
 P1 Start point
 P2 End point
 P3 Offset point
 Unknown
 d1 Δ Line
 d2 Δ Offset
 P4 COGO (base) point

Set Point by Distance Offset

Use the **Set Point by Distance Offset** subprogram to calculate the coordinates of a new point in relation to a line from known longitudinal and offset distances.

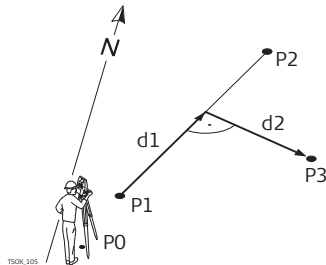

- Known
 P0 Instrument station
 P1 Start point
 P2 End point
 d1 Δ Line
 d2 Δ Offset
 Unknown
 P3 COGO point

Plane Offset

Use the **Plane Offset** subprogram to calculate the coordinates of a new point and its height and offset, in relation to a known plane and offset point.

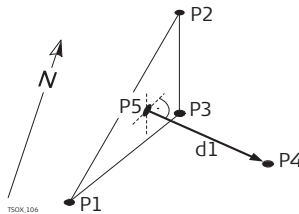

- Known
 P1 Point 1 which defines plane
 P2 Point 2 which defines plane
 P3 Point 3 which defines plane
 P4 Offset point
 Unknown
 P5 COGO (intersection) point
 d1 Offset

6.11.5

Line - Extension

Access

Select **Line - Extension** from the **COGO** Main Menu.

Line - Extension

Use the **Line - Extension** subprogram to calculate the extended point from a known base line.

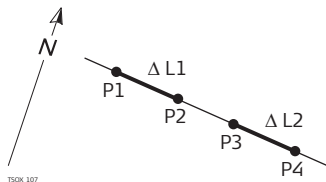

- Known
 P1 Baseline start point
 P3 Baseline end point
 $\Delta L1, \Delta L2$ Distance
 Unknown
 P2, P4 Extended COGO points

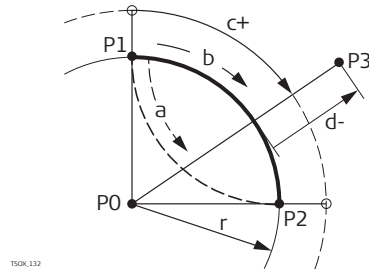

Description

Road 2D is a program used to measure or stake out points relative to a defined element. The element can be a line, curve or spiral. Chainage, incremental stake outs and offsets (left and right) are supported.



- P0 Center point
- P1 Start point of arc
- P2 End point of arc
- P3 Point to stake
- a Anti-clockwise
- b Clockwise
- c+ Distance from start of arc, following curve
- d- Perpendicular offset from arc
- r Radius of arc

Access

1. Select  **Programs** from the Main Menu.
2. Select  **Road 2D** from the **Programs** Menu.
3. Complete program pre-settings. Refer to "5 Programs - Getting Started".
4. Select the element type:
 - Straight
 - Curve
 - Spiral

Elements

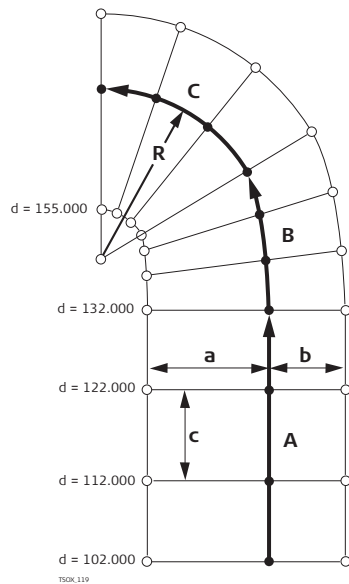

- A Straight
- B Spiral
- C Curve
- R Radius
- a Perpendicular offset left
- b Perpendicular offset right
- c Increment
- d Chainage

Define the element step-by-step

1. Enter, measure or select from memory the start and end points.
2. For curve and spiral elements the **Road 2D** screen for defining the element appears.

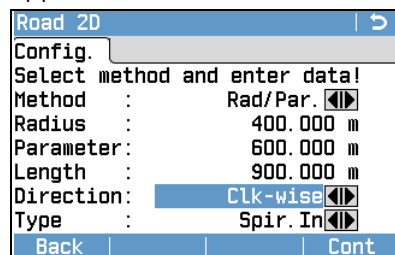

3. For a curve element:
 - Enter the radius and curve direction.
 - Press **Cont.**
- For a spiral element:
 - Select the method to be used, **Rad/Par.** or **Rad/Len.**

- Enter the radius and parameter, or radius and length, depending on the method chosen.
- Select the type and direction of the spiral.
- Press **Cont.**

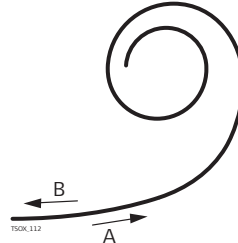

Spiral type
 A Spiral in
 B Spiral out

4. When the element has been defined the **Road 2D - Config.** appears.

Chainage and method

Enter the chainage values and press:

- **Stake:** to select the point and offset (center, left or right), to stake out and start the measurement. The correction from actual point to stake out point is shown on the display.
- **Check:** to measure, or select points from memory, to calculate the chainage, line and offset from the defined element.

Enter stakeout values

Road 2D	
Config.	➔
Enter chainage of Start Point!	
Chainage:	0.000 m
Start Pt:	402
End Pt :	403
Length :	608.835 m
New Stake Check	

Next step

- If in stakeout mode, press **Cont** to begin staking out.
- Or, if in measurement mode, press **Meas** to measure and record.

6.13
6.13.1

Road 3D
Starting Road 3D

Description

Road 3D is a program used to stake out points or for as-built checks relative to a road alignment, including slopes. It supports the following features:

- Horizontal alignments with the elements straight, curve, and spiral (entry and exit as well as partial).
- Vertical alignments with the elements straight, curve and quadratic parabola.
- Upload of horizontal and vertical alignments which are in gsi data format of FlexOffice Road Line Editor.
- Creation, view and deletion of alignments onboard.
- Use of design height of vertical alignments or manually entered heights.
- Log file via Format manager of FlexOffice.

Road 3D methods

Road 3D has the following subprograms:

- Subprogram Check
- Subprogram Stake
- Subprogram Check Slope
- Subprogram Stake Slope



The program can be trialled 15 times. After 15 trials, it is necessary to enter the licence code.

Road 3D step-by-step

1. Create or upload road alignments.
2. Select horizontal and/or vertical alignment files.
3. Define stake/check/slope parameter.
4. Select one of the Road 3D subprograms.



- The alignment file data has to be in the same data structure as FlexOffice Road Line Editor. These gsi files have unique identifiers for each element which are used by the program.
- The alignments must be continuous because geometrical gaps and chainage equations are not supported.
- The file name for the horizontal alignment file must have the prefix ALN, for example, ALN_HZ_Axis_01.gsi. The file name for the vertical alignment files must have the prefix PRF, for example PRF_VT_Axis_01.gsi. File names can be 16 characters long.
- The uploaded or created road alignments are permanent and stored even if the program is closed.
- Road alignments can be deleted onboard or via FlexOffice Data Exchange Manager.
- Road alignments cannot be edited onboard. This needs to be done via FlexOffice Road Line Editor.

Elements of a road project

Road projects consist, in general, of a horizontal and a vertical alignment.

Any project point P1 has E, N and H coordinates in a determined coordinate system and has three positions.

- P1' Position on natural surface
- P1'' Position on vertical alignment
- P1''' Position on horizontal alignment

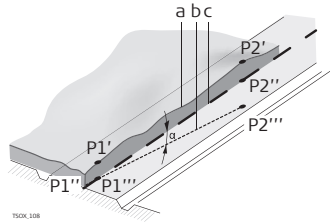

With a second point P2 the alignment is defined.

- P1' P2' Projection of the alignment onto the natural surface.
- P1'' P2'' Vertical alignment
- P1''' P2''' Horizontal alignment
- α Grade angle between the vertical and horizontal alignment.
- a Natural surface
- b Horizontal alignment
- c Vertical alignment

Horizontal geometry elements

For onboard input Road 3D supports the following elements for horizontal alignments.

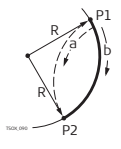
Element	Description
Straight	<p>A straight has to be defined by:</p> <ul style="list-style-type: none"> • Start point (P1) and end point (P2) with known Easting and Northing coordinates.  <ul style="list-style-type: none"> P1 Start point P2 End point
Curve	<p>A circular curve has to be defined by:</p> <ul style="list-style-type: none"> • Start point (P1) and end point (P2) with known Easting and Northing coordinates. • Radius (R). • Direction: Clockwise (b) or Anticlockwise (a).  <ul style="list-style-type: none"> P1 Start point P2 End point R Radius a Anticlockwise direction b Clockwise direction
Spiral / Clothoid	<p>A spiral is a transition curve whose radius changes along its length. A spiral has to be defined by:</p> <ul style="list-style-type: none"> • Start point (P1) and end point (P2) with known Easting and Northing coordinates. • Radius at the start of the spiral (R). • Spiral parameter ($A = \sqrt{L \cdot R}$) or length (L) of the spiral. • Direction: Clockwise or Anticlockwise. • Spiral type: Spiral in or Spiral out.

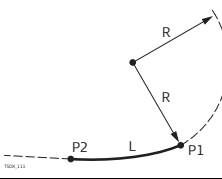
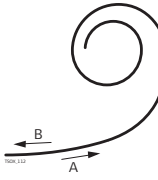
Element	Description
	 <p>P1 Start point P2 End point R Radius L Length</p>
Spiral types	<ul style="list-style-type: none"> • Entry spiral (Spiral in = A): Spiral with a radius of infinity at the start and a given radius at the end. • Exit spiral (Spiral out = B): Spiral with a given radius at the start and radius of infinity at the end. • Partial/Ovoid spiral: A spiral with a given radius at the start and another given radius at the end.  <p>A Entry spiral B Exit spiral</p>

Vertical geometry elements

For onboard input Road 3D supports the following elements for vertical alignments.

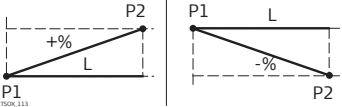
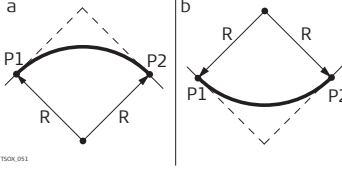
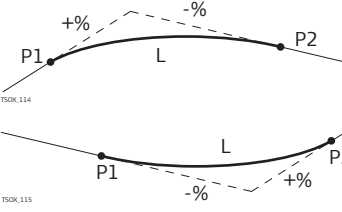
Element	Description
Straight	<p>A straight has to be defined by:</p> <ul style="list-style-type: none"> Start chainage and start height of P1. End chainage and end height of P2, or length (L) and slope (%).  <p>P1 Start point P2 End point L Length % Slope</p>
Transition curve	<p>A circular curve has to be defined by:</p> <ul style="list-style-type: none"> Start chainage and start height of P1. End chainage and end height of P2. Radius (R). Type: Convex (crest) or Concave (sag).  <p>a Convex b Concave P1 Start point P2 End point R Radius</p>
Quadratic parabola	<p>A quadratic parabola has the advantage that the rate of change of grade is constant, resulting in a "smoother" curve. A quadratic parabola has to be defined by:</p> <ul style="list-style-type: none"> Start chainage and start height of P1. End chainage and end height of P2. Parameter, or Length (L), grade of entry straight (Grade In) and grade of exit straight (Grade Out).  <p>P1 Start point P2 End point L Length % Slope</p>

Horizontal and vertical geometry elements combined

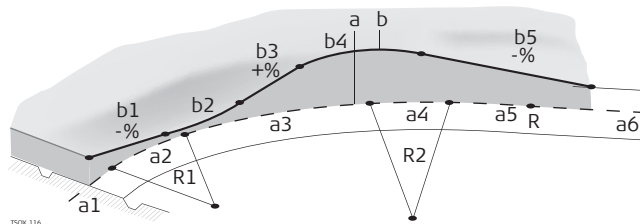

a = Horizontal alignment (top view)

R1 Radius 1

R2 Radius 2

a1 Straight

a2 Curve with R1

a3 Partial spiral with R1 and R2

a4 Curve with R2

a5 Spiral out with R2 and $R = \infty$

a6 Straight

b = Vertical alignment (front view)

b1 Straight

b2 Curve

b3 Straight

b4 Parabola

b5 Straight

- Tangent point



Start and end chainage and tangent points can be different for the horizontal and vertical alignments.

Slope elements

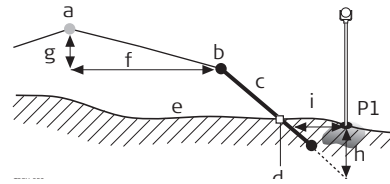

P1 Measured point

a Horizontal alignment

b Hinge point

c Slope

d Catch point

e Natural surface

f Defined offset

g Defined height difference

h Cut situation for defined slope

i Δ Offset to catch point

Explanation of the slope elements:

a) Horizontal alignment at a defined chainage.

b) Hinge point, is defined by entered offset left/right and height difference.

c) Slope = ratio.

d) Catch point, or daylight point, indicates the point of intersection between the slope and the natural surface. Both the hinge point and the catch point lie on the slope.

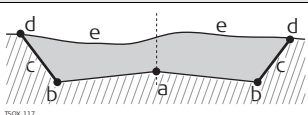
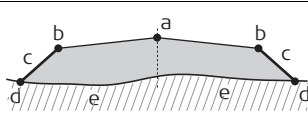

e) Natural surface, is the undisturbed surface before project construction.

Cut / Fill	Description
Cut situation	 <p>a) Horizontal alignment b) Hinge point c) Slope d) Catch point e) Natural surface</p>
Fill situation	 <p>a) Horizontal alignment b) Hinge point c) Slope d) Catch point e) Natural surface</p>



Description

Create horizontal and vertical road alignment files with FlexOffice Road Line Editor and upload them onto the instrument using the Data Exchange Manager. Alternatively, horizontal and vertical road alignments can be created onboard the instrument.

Access

1. Select  **Programs** from the Main Menu.
2. Select  **Road 3D** from the **Programs** Menu.
3. Complete program pre-settings. Refer to "5 Programs - Getting Started".

Select Alignment File:

Field	Description
Horiz. Aln.	List of available horizontal alignment files.  Using a horizontal alignment file is mandatory.
Verti. Aln.	List of available vertical alignment files.  Using a vertical alignment file is not mandatory. A height can be defined manually instead.

Next step

- Either, press **New** to name and define a new alignment file.
- Or, press **Cont** to select an existing alignment file and proceed to the **Define Stake/Check/Slope** values screen.

Define Stake/Check/Slope

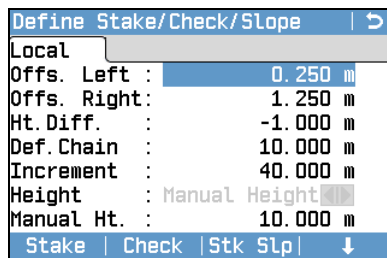

Define Stake/Check/Slope	
Local	
Offs. Left :	0.250 m
Offs. Right :	1.250 m
Ht. Diff. :	-1.000 m
Def. Chain :	10.000 m
Increment :	40.000 m
Height :	Manual Height
Manual Ht. :	10.000 m
Stake Check Stk Slp	↓

Stake

To start the subprogram Stake.

Check

To start the subprogram Check.

Stk Slp

To start the subprogram Stake Slope.

↓ Ch Slp

To start the subprogram Check Slope.

Field	Description
Offs. Left	Horizontal offset to the left of the horizontal alignment.
Offs. Right	Horizontal offset to the right of the horizontal alignment.
Ht.Diff.	Vertical offset, either up or down, from the horizontal alignment.
Def.Chain	Defined chainage for stake out.
Increment	Value by which the defined chainage can be incremented or decremented in subprograms Stake and Stake Slope.
Height	<p>Manual Height Height reference for height calculations. If enabled this height is used for all subprograms.</p> <p>Use Design Hgt. The height reference for height calculations is the selected vertical alignment file.</p>
Manual Ht.	Height to be used for Manual Height .

Next step

Select a softkey option, **Stake**, **Check**, **Stk Slp** or **↓ Ch Slp**, to proceed to a subprogram.

Description

The subprogram Stake is used to stake out points relative to an existing alignment. The height difference is relative to a vertical alignment or manually entered height.

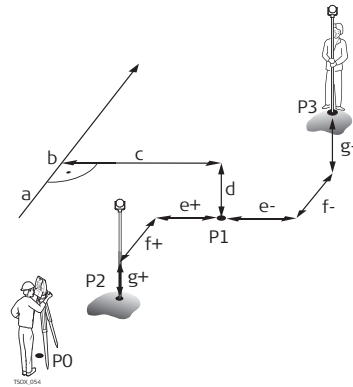

- P0 Instrument station
- P1 Target point
- P2 Measured point
- P3 Measured point
- a Horizontal alignment
- b Defined chainage
- c Offset
- d Height difference
- e+ Δ Offset, positive
- e- Δ Offset, negative
- f+ Δ Chainage, positive
- f- Δ Chainage, negative
- g+ Δ Height, positive
- g- Δ Height, negative

Access

Press **Stake** from the **Define Stake/Check/Slope** values screen.

Stakeout

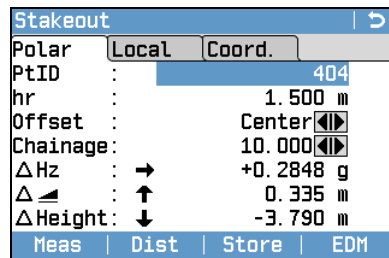

To find/enter codes, press the FNC/Favourites key and select **Coding**.

Field	Description
Chainage	Selected chainage to stake out.
ΔHz	Angle offset: Positive if the stake out point is to the right of the measured point.
Δ	Horizontal offset: Positive if the stake out point is further away than the measured point.
ΔHeight	Height offset: Positive if the stake out point is higher than the measured point.
ΔChain	Longitudinal offset: Positive if the stake out point is further away than the measured point.
ΔOffset	Perpendicular offset: Positive if the stake out point is to the right of the measured point.
Def.East	Calculated East coordinate of the stake out point.
Def.North	Calculated North coordinate of the stake out point.
Def.Hght	Calculated Height of the stake out point.

Next step

- Either, press **Meas** to measure and record.
- Or, press ESC to return to the **Define Stake/Check/Slope** values screen.

Description

The subprogram Check is used for as-built checks. The points can be measured or selected from the memory. The chainage and offset values are relative to an existing horizontal alignment, and the height difference is relative to a vertical alignment or manually entered height.

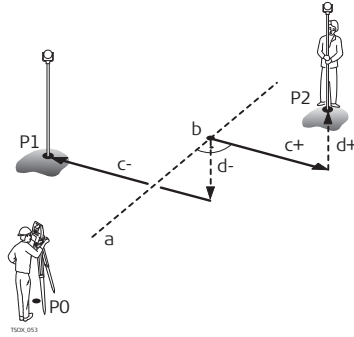

- P0 Instrument station
- P1 Target point
- P2 Target point
- a Horizontal alignment
- b Chainage
- c+ Offset, positive
- c- Offset, negative
- d+ Height difference, positive
- d- Height difference, negative



Defined chainage and increment values will not be considered in the subprogram Check.

Access

Press **Check** from the **Define Stake/Check/Slope** values screen.

3D-Road Check

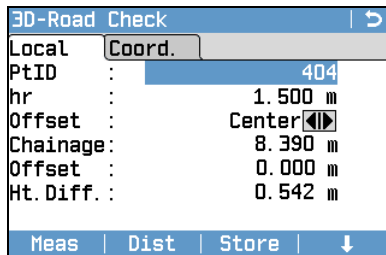

Field	Description
Offset	Defined horizontal offset. Left, Right or Centre .
Chainage	Current chainage from measured point.
Offset	Perpendicular offset to alignment.
Ht.Diff.	Height difference between the measured point and the defined height.
ΔEast	Calculated difference in Easting coordinate between the measured point and the alignment element.
ΔNorth	Calculated difference in Northing coordinate between the measured point and the alignment element.

Next step

- Either, press **Meas** to measure and record.
- Or, press ESC to return to the **Define Stake/Check/Slope** values screen.

Description

The subprogram Stake Slope is used to stake out the catch point, which is the intersection point of a defined slope with the natural surface. The slope is always defined as starting from a hinge point. If the parameter offset right/left and height difference are not entered, the point at the defined chainage on the horizontal alignment is the hinge point.

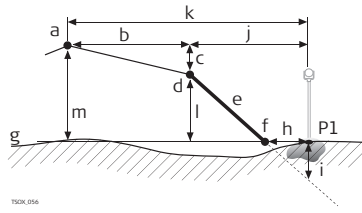

- P1 Measured point
- a Horizontal alignment
- b Defined offset
- c Defined height difference
- d Hinge point
- e Defined slope
- f Catch point
- g Natural surface
- h Δ Offset to catch point
- i Cut/fill to catch point
- j Offset to hinge point
- k Offset to alignment
- l Height difference to hinge point
- m Height difference to alignment

Access

Press **Stk Slp** from the **Define Stake/Check/Slope** values screen.

Define Slope Stakeout

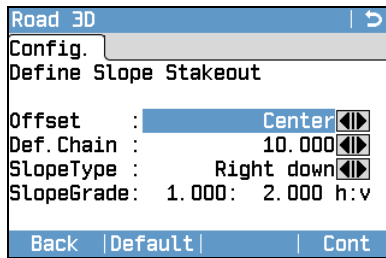

Field	Description
Offset	Horizontal offset from the horizontal alignment to define the hinge point.
Def.Chain	Defined chainage for stakeout.
SlopeType	Type of slope. Refer to "Slope Type".
SlopeGrade	Slope ratio. Refer to " Slope Grade".

Slope Type

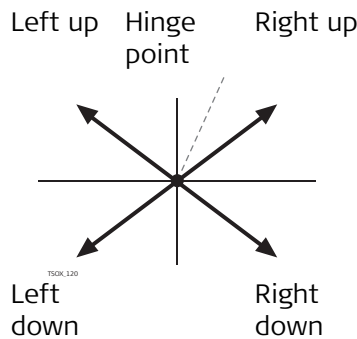

- Left up
Creates an upward plane extending to the left of the defined hinge point.
- Right up
Creates an upward plane extending to the right of the defined hinge point.
- Left down
Creates a downward plane extending to the left of the defined hinge point.
- Right down
Creates a downward plane extending to the right of the defined hinge point.

Slope Grade

Ratio of the slope. The unit for slope grade is defined in the **Regional Settings** screen. Refer to "4.2 Regional Settings".

Next step

Press **Slope Stakeout** to proceed to the **Slope Stakeout** screen.

Slope Stakeout

Slope Stakeout	
Local	Hinge Alignmt
PtID	: 404
hr	: 1.500 m
Def. Chain	: 10.000
ΔChain	: -0.052 m
ΔOffset	: 0.088 m
Cut	: 0.044 m
Act. Slp	: 1: 2.047 h:v
Meas Dist Store ↓	

Field	Description
DefChain	Defined chainage for stake out.
ΔChain	Difference between the defined chainage and the measured chainage.
ΔOffset	Horizontal offset between the catch point of defined slope and the measured position.
Cut/Fill	Vertical offset between the catch point of the defined slope and the measured position. A cut is above the slope, a fill is below the slope.
Act.Slope	Measured slope of the reflector position to the hinge point.
Offs.Hng	Measured offset to the horizontal alignment including offset right and offset left.
ΔH Hinge	Height difference to the hinge point. The vertical offset between the defined height at the current chainage, and the measured position, including the defined height difference.
↙ Hinge	Slope distance from the measured point to the hinge point.
Height	Height value of the measured point.
Act. Ch.	The measured chainage.
Offs.Aln	Measured offset to the horizontal alignment excluding offset right and offset left.
ΔH Aln	Height difference to the alignment. The vertical offset between defined height at the current chainage, and the measured position, excluding the defined height difference.
↙ Aln	Slope distance from the measured point to the alignment.

Sign convention

Cut situation

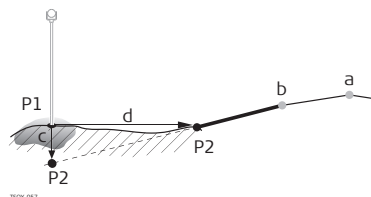

- P1 Measured point
- P2 Catch point
- a Horizontal alignment
- b Hinge point
- c Cut
- d Δ Offset to catch point

Fill situation

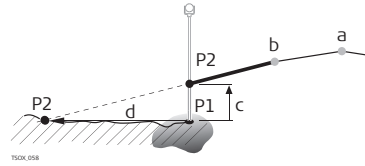

- P1 Measured point
- P2 Catch point
- a Horizontal alignment
- b Hinge point
- c Fill
- d Δ Offset to catch point

Next step

- Either, press **Meas** to measure and record.
- Or, press ESC to return to the **Define Stake/Check/Slope** values screen.

Description

The subprogram Check Slope is used for as-built checks and to get information about slopes, for example on a natural surface. If the parameter offset left/right and height difference are not entered, the point on the horizontal alignment is the hinge point.

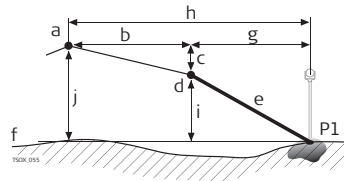

- P1 Measured point
- a Horizontal alignment
- b Defined offset
- c Defined height difference
- d Hinge point
- e Actual slope
- f Natural surface
- g Offset to hinge point
- h Offset to alignment
- i Height difference to hinge point
- j Height difference to alignment



Defined chainage and increment values will not be considered in the subprogram Check.

Access

Press **↓ Ch Slp** from the **Define Stake/Check/Slope** values screen.

Slope Check Hinge Val.

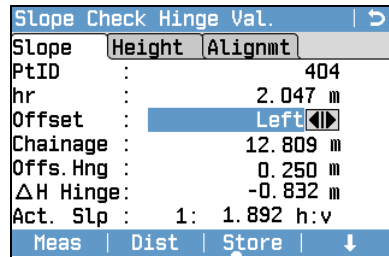

Field	Description
Offset	Defined horizontal offset. Left, Right or Center.
Chainage	Current chainage from measured point.
Offs.Hng	Offset to hinge. Measured offset to the horizontal alignment including offset right and offset left.
ΔH Hinge	Height difference to the hinge point. The vertical offset between the defined height at the current chainage, and the measured position including defined height difference.
Act. Slp	The measured slope ratio of the measured point to the hinge point.
↙ Hinge	Slope distance from the measured point to the hinge point.
Height	Height value of the measured point.
Offs.Aln	Measured offset to the horizontal alignment excluding offset right and offset left.
ΔH Aln	Height difference to the alignment. The vertical offset between defined height at the current chainage, and the measured position, excluding the defined height difference.
↙ Aln	Slope distance from the measured point to the alignment.

Next step

- Either, press **Meas** to measure and record.
- Or, press ESC to return to the **Define Stake/Check/Slope** values screen.
- Or, continue selecting ESC to exit the application.

6.14

6.14.1

Traverse

Overview



The program Traverse can be trialled 15 times. After 15 trials, it is necessary to enter a licence code.

Description

Traverse is a program used to establish control networks whereby other survey operations such as topographic surveys or point stake outs can be completed. The Traverse methods include 2D Helmert transformation, compass rule and transit rule.

2D Helmert transformation

A Helmert transformation is calculated based on two control points. These must be the start point and the end, or closing, station. Shift, rotation and scale factor will be computed and applied to the traverse. Starting a traverse without an initial backsight measurement will automatically result in a Helmert transformation.

Compass rule

The coordinate misclosure will be distributed with respect to the length of the traverse legs. The compass rule assumes that the biggest error comes from the longest traverse observations. This method is suitable when the precision of the angles and distances are approximately equal.

Transit rule

The coordinate misclosure will be distributed with respect to the coordinate changes in Easting and Northing. Use this method if the angles were measured with a higher precision than the distances.



Traverse step-by-step

1. Start and configure Traverse.
2. Enter station data.
3. Select starting method.
4. Measure a backsight point or go directly to step 5..
5. Measure a foresight point.
6. Repeat for the number of sets.
7. Move to the next station.

Traverse options

- It is also possible to observe sideshots and check points during the traverse, however, check points are not included in the traverse adjustment.
- At the end of the traverse, results are displayed and an adjustment may be calculated if desired.

Access

1. Select  **Programs** from the Main Menu.
2. Select  **Traverse** from the **Programs** Menu.
3. Complete program pre-settings.
 - **F1 Set Job:**
Only one traverse per job is allowed. If an adjusted or finished traverse is already part of the selected job, then select another job. Refer to "5 Programs - Getting Started".
 - **F2 Set Tolerances:**
Use Tolerances: Yes to activate the use of tolerances. Enter limits for horizontal direction (the difference between measured and calculated azimuth to the closing point), distance (the distance between known and measured closing point), and for differences in Easting, Northing and Height. If the adjustment results, or the deviation for a check point, exceed these limits a warning message appears. Press **Cont** to save the limits and return to the Pre-settings screen.
4. Select **F4 Start** to begin the program.



It is not recommended to start a traverse if the memory is almost full. Doing so, may mean the traverse measurements and results cannot be saved. Accordingly, a message is displayed if less than 10% of the memory is free.

Traverse configuration

Field	Description
Traverse ID	Name of the new traverse.
Desc.	Description, if desired.
Operator	Name of the user who will be using the new traverse, if desired.
Method	<p>B'F'F'B" All points are measured in face I, then all points are measured in face II in reverse sequential order.</p> <p>B'B"FF'F' The backsight point is measured in face I immediately followed by face II. Other points are measured in alternating face order.</p> <p>B'F' All points are measured in face I only.</p>
No. of Sets	Number of sets. Limited to 10.
Use Face-Tol.	Important when measuring with face I and II. This checks if both measurements are within a defined limit. If the limit is exceeded, a warning message is displayed.
Face-Tol.	The limit that will be used for checking the face tolerance.

Next step

Press **Cont** to confirm the traverse configuration and proceed to the **Enter Station Data** screen.

Measure Traverse - Enter Station Data

Field	Description
Stat.ID	Name of the station.
hi	Height of the instrument.
Desc.	Description of the station, if desired.



Every Traverse must start on a known point.

Next step

Press **Cont** to confirm station data and proceed to the **Traverse - Select** screen.

Access

From the **Traverse - Select** screen select one of the following:

- **F1 ...w/o known Backsight:** Starts the traverse without a known backsight. The measurements begin to a foresight point.
- **F2 ...with known Backsight:** Starts the traverse with a known backsight.
- **F3 ...with known Azimuth:** Starts the traverse with a user-defined azimuth.

Without known backsight

Start a traverse without a known backsight

- Start on a known point without an initial measurement to a known backsight.
- Stop on a known point, or make a final foresight measurement to a known closing point.

If the coordinates of the start station are unknown, the **Station Setup** program can be run before the traverse. A Helmert transformation will be performed at the end of the traverse.

If the traverse is left open, then the calculations are based on the system azimuth.

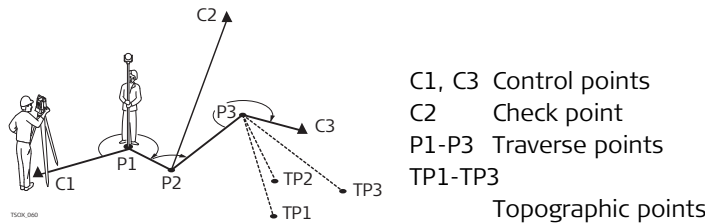

With known back-sight

Start a traverse with a known backsight

- Start on a known point with an initial measurement to a known backsight.
- Stop on a known point and optionally measure to a known closing point.

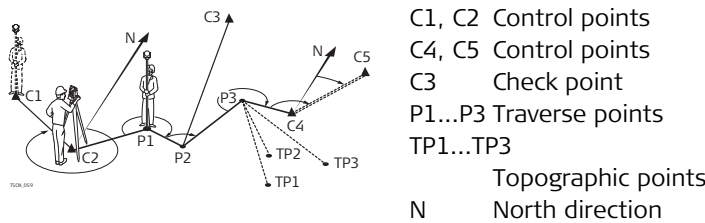

With known azimuth

Start a traverse with a known azimuth

- Start on a known point, aim to any direction (e.g. a tower) and define this direction as the reference. This method is often used to define a 0-direction.
- Stop/end the traverse either on a known point or a traverse point and then measure to a known closing point, or leave the traverse open. Refer to "6.14.5 Closing a Traverse".

If using the current system azimuth, for example from the **Stn.Setup** program, then simply confirm the suggested Hz-value in the **Set Horizontal Angle** screen.

Measure traverse - Sight Backsight!

Field	Description
BS ID	Point ID of the backsight point.
Remark	Description of the backsight point.
Stat.ID	Name of the station.

Next step

Depending on the traverse method configured, after the measurement either the **Sight Backsight!** screen stays active for measuring the backsight point in a second face, or the **Sight Foresight!** screen appears for measuring the foresight point.

**Measure traverse -
Sight Foresight!**

Next step

Depending on the traverse method configured, after the measurement either the **Sight Foresight!** screen stays active for measuring the foresight point in a second face, or the **Sight Backsight!** screen appears for measuring the backsight point.

Interrupt a set

To interrupt a set, press ESC to exit the backsight or foresight screen. The **Continue with...** screen will appear.

Continue with...

Field	Description
F1 Redo last measurement	Returns to last measured point, can be either a backsight or a foresight point. The last measurement is not stored.
F2 Redo whole station	Returns to first sight point screen. The data from the last station is not stored.
F3 Exit Traverse	Returns to the Programs Menu. The traverse stays active and can be continued later. The data from the last station is lost.
F4 Back	Returns to the previous screen where ESC was pressed.

**Repetitive loop for
the number of sets**

Alternating between screens for the backsight and foresight measurements continues according to the configured number of sets.

The number of sets and the face are indicated in the top right corner of the screen. For example 1/I means set 1 in face I.

Number of defined sets is achieved

When the number of defined sets is achieved, the **Traverse - Select** screen is displayed automatically. The accuracy of the set measurements is checked. The set can be accepted or redone.

Moving ahead with the traverse

From the **Traverse - Select** screen, select an option to move ahead with the traverse, or press ESC to redo the last station.

Field	Description
F1 Survey Side-shot	<p>Enables the measurement of standard survey and topographic points. Measured points are stored with a Traverse flag. If the traverse is finally adjusted, these points will be updated.</p> <p>Close To exit the Measure Sideshot! screen and returns to the Traverse - Select screen.</p>
F2 Move to next Station	<p>Move to the next station. The instrument can either be left on or turned off. If the instrument is turned off and then turned on again later, the message Last traverse not yet finished or processed! Do you really want to start a new traverse ? All existing data will be overwritten! will display. Selecting Yes will re-open the Traverse to continue at the new station.</p> <p>The start screen for the next station is similar to the Enter Station Data screen. The point ID of the foresight point of the last station is suggested as station ID automatically.</p> <p>Run through the loop of backsight and foresight measurements until the number of sets is reached.</p>
F3 Measure Checkpoint	<p>By measuring a check point it is possible to check whether the Traverse is still within certain deviations. A check point is excluded from the traverse calculation and adjustment, however, all measurement data and results observed from a check point are stored.</p> <ol style="list-style-type: none"> 1) Enter the name of the check point and the height of the reflector. 2) Press Cont to go to the next screen. 3) Measure the check point. The differences in Easting, Northing and Height are displayed. <p>A message will appear if the tolerances defined in the Traverse configuration are exceeded.</p>

Next step

Close the traverse by selecting **Close** in the **Sight Foresight!** screen after a backsight point measurement, but before the foresight point measurement.

Access

Close the traverse by selecting **Close** in the **Sight Foresight!** screen after a backsight point measurement, but before the foresight point measurement.

Close Traverse...

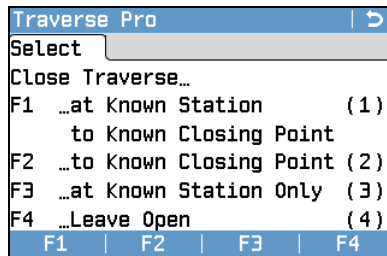

F1 - F4

To select menu item.

Field	Description
F1 ...at Known Station to Known Closing Point	To close a traverse at a known station to a known closing point. Use when setup on the closing station, and the coordinates for the station and the closing point are known.  If this method is chosen a distance measurement is mandatory. 1) Input the data for both points. 2) Measure to the closing point. 3) The results are displayed.
F2 ...to Known Closing Point	To close a traverse to a known closing point. Use when setup on an unknown station and only the coordinates of the closing point are known. 1) Input the data for the point. 2) Measure to the closing point. 3) The results are displayed.
F3 ...at Known Station Only	To close a traverse at a known station only. Use when setup on the closing station and the coordinates for it are known. 1) Input the data for the closing station. 2) The results are displayed.
F4 ...Leave Open	To leave the traverse open. There is no last traverse station. 1) The results are displayed.

Next step

Select an option, from the **Close Traverse...** menu to proceed to the **Traverse Results** screen.

Traverse Results

Traverse Results	
Result1	Result2
Traverse ID:	TRAV_
Start Stn. :	1
End Stn. :	1
No. of Stn. :	3
Total Dist. :	23.920 m
1D Accuracy:	1/2.5902
2D Accuracy:	1/9.9819
Adjust	ViewTol
S-Shot	EndTrav

Adjust

To calculate an adjustment. Unavailable when the traverse is left open.

ViewTol

To view the tolerances for the traverse.

S-Shot

To measure a sideshot.

EndTrav

To record the results and end the traverse.

Field	Description
Traverse ID	Name of the traverse.
Start Stn.	Point ID of the start station.
End Stn.	Point ID of the end station.
No. of Stn.	Number of stations in the traverse.
Total Dist.	Total distance of the traverse.
1D Accuracy	Accuracy in 1D $1/\left(\frac{\text{Length of Traverse}}{\text{Height Misclosure}}\right)$
2D Accuracy	Accuracy in 2D $1/\left(\frac{\text{Length of Traverse}}{\text{Linear Misclosure}}\right)$
L of Error	Length/distance error.
Azimuth Err.	Azimuth closure error.
ΔEast, ΔNorth, ΔHeight	Calculated coordinates.

Next step

Press **Adjust** from the **Traverse Results** screen to calculate the adjustments.

Set Adjustment Parameter

Set Adjustment Parameter	
Adjust	
No. of Stn. :	3
Azimuth Err. :	---- g
Misc.-Distr. :	Compass
Height-Distr. :	Equal
Note:	Angles adjusted equally!
Scale :	-----
Use Scale :	No
	Cont

Field	Description
No. of Stn.	Number of stations in the traverse.
Azimuth Err.	Azimuth closure error.
Misc.-Distr.	For misclosure distribution.  Angle misclosures are distributed equally. Compass For surveys where angles and distances were measured with equal precision. Transit For surveys where angles were measured with a higher precision than the distances.
Height-Distr	The height error can be distributed equally, by distance or not at all.
Scale	PPM value defined by the calculated distance between start and end point divided by the distance measured.
Use Scale	Whether to use the calculated ppm.



- Depending on the number of measured points the calculation may take some time. A message is displayed during the processing.
- Adjusted points are stored as fixpoints with an additional prefix, for example point BS-154.B is stored as CBS-154.B.
- After the adjustment the Traverse program is exited and the system returns to the Main Menu.

Messages

The following are important messages or warnings that may appear.

Messages	Description
Memory is nearly full! Do you want to continue ?	This message occurs if less than 10% of the memory is free. It is not recommended to start a traverse if the memory is almost full. Doing so, may mean that the traverse measurements and the results cannot be saved.
Current job contains an adjusted Traverse. Select a different job!	Only one traverse per job is allowed. Another job must be selected.
Last traverse not yet finished or processed! Do you want to continue ?	The Traverse program was quit without closing a traverse. The traverse can be continued on a new station, left unfinished, or a new traverse started and the old traverse data overwritten.
Do you really want to start a new traverse ? All existing data will be overwritten!	Confirmation of this message will start a new traverse and the old traverse data will be overwritten.
Redo last station ? Measurements of this station will be overwritten!	Confirming returns to the first sight point screen for the previous station measurements. The data from the last station is not stored.
Exit Traverse application ? Current station data will be lost!!!	Quitting the program returns to the Main Menu. The traverse can be continued later, but the current station data will be lost.
Out of Tolerance!	The tolerance limits have been exceeded. If not accepted, the calculations can be redone.
Traverse points are re- calculated and newly stored...	An information message displayed while the adjustment is calculated.



7



Favourites

7.1

Overview





Description

Favourites can be accessed by pressing the FNC/Favourites key,  or  from any measurement screen.

- The FNC/Favourites key opens the **Favourites** Menu and a function can be selected and activated.
-  or , activates the specific function assigned to the key. Any function from the **Favourites** Menu can be assigned to these keys. Refer to "4.1 Work Settings".

Favourites

 The symbol of an unavailable favourite is crossed out.

Favourite	Description
 Home	Returns to the Main Menu.
 Level	Activates the laser plummet and electronic level. Refer to "Level up with the electronic level step-by-step".
 Offset	Refer to "7.2 Target Offset".
 Del.Rec	Deletes the last recorded data block. This can be either a measurement block or a code block.  Deleting the last record is not reversible! Only records recorded in Survey and Quick Survey can be deleted.
 Coding	Starts Coding to select a code from a codelist or enter a new code. Same functionality as the softkey Code .
 PIN-lock	Refer to "9.5 Instrument Protection with PIN".
 NP\leftrightarrowP	Changes between the two EDM modes. Refer to "4.5 EDM Settings". Available for instrument with non-prism mode.
 Laserpt.	Activates/deactivates the visible laser beam for illuminating the target point. Available for instrument with non-prism mode.
 EDM Track	Refer to "7.5 EDM Tracking".
 Sig.Refl.	To view EDM Signal reflection value.
 H-Trans	Height Transfer. Refer to "6.2 Station Setup".
 Hidden Pt	Refer to "7.3 Hidden Point".
 CheckTie	Refer to "7.4 Check Tie".
 BS-Check	Refer to "7.6 Backsight Check".
 Illumin.	To turn the keyboard illumination on/off. Available for Color&Touch display.
 Touch	To deactivate/activate the touch screen. Available for Color&Touch display.
Distance Unit	Sets the distance measurement unit. Available for the user keys.
Angular Unit	Sets the angle measurement unit. Available for the user keys.

7.2

7.2.1

Target Offset

Overview

Description

This favourite calculates the target point coordinates if it is not possible to set up the reflector, or to aim at the target point directly. The offset values (length, trav. and/or height offset) can be entered. The values for the angles and distances are calculated to determine the target point.

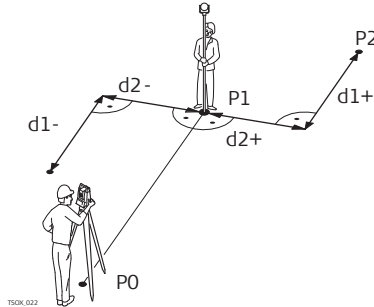

- P0 Instrument station
- P1 Measured point
- P2 Calculated offset point
- d1+ Length offset, positive
- d1- Length offset, negative
- d2+ Trav. offset, positive
- d2- Trav. offset, negative

Access

1. Press the FNC/Favourites key when within any program.
2. Select  **Offset** from the **Favourites** Menu.

Enter offset values

Offset	
Values	
Enter offset values!	
Trav. Off. :	0.000 m
Length Off. :	0.000 m
Height Off. :	0.000 m
Mode :	Reset after REC
Default Cylindr Cont	

Default

To reset offset values to 0.

Cylindr

To enter cylindrical offsets.

Field	Description
Trav. Off.	Perpendicular offset. Positive if the offset point is to the right of the measured point.
Length Off.	Longitudinal offset. Positive if the offset point is further away than the measured point.
Height Off.	Height offset. Positive if the offset point is higher than the measured point.
Mode	Period for which the offset is to apply. <ul style="list-style-type: none"> Reset after REC The offset values are reset to 0 after the point is saved. Permanent The offset values are applied to all further measurements.
	The offset values are always reset to 0 when the program is quit.

- Either, press **Cont** to calculate the corrected values and return to the program from which the offset favourite was started. The corrected angle and distances are displayed as soon as a valid distance measurement has been triggered or exists.
- Or, press **Cylindr** to enter cylindrical offsets. Refer to "7.2.2 Cylindrical Offset Subprogram".

Description

Determines the coordinates of the centre point of cylindrical objects and their radius. The horizontal angle to points on both the left and right sides of the object are measured, and the distance to the object as well.

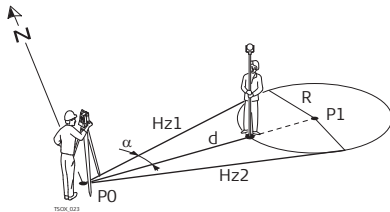

- P0 Instrument station
- P1 Centre point of cylindrical object
- Hz1 Horizontal angle to a point on the left side of the object
- Hz2 Horizontal angle to a point on the right side of the object
- d Distance to the object in the middle between Hz1 and Hz2
- R Radius of cylinder
- α Azimuth from Hz1 to Hz2

Access

Press **Cylindr** from the **Offset** screen.

Cylindrical Offset

Cylindrical Offset	
Polar	
Hz Left :	52.0000 g
Hz Right :	95.0000 g
Δ Hz :	← -21.5000 g
PrismOffset:	0.000 m
HzLeft HzRight Meas ↓	

HzLeft

To trigger measurement for the left side of the object.

HzRight

To trigger measurement for the right side of the object.

Field	Description
Hz Left	Measured horizontal direction to the left side of the object. Using the verticalhair, aim at the left side of the object, then press HzLeft .
Hz Right	Measured horizontal direction to the right side of the object. Using the verticalhair, aim at the right side of the object, then press HzRight .
ΔHz	Deviation angle. Rotate the instrument to aim in the direction of the centre point of the cylindrical object, such that Δ Hz is zero.
PrismOffset	Prism offset distance between the centre of the prism and the surface of the object to be measured. If the EDM mode is Non-Prism, the value is set to zero automatically.

Next step

Once **Δ Hz** is zero, press **Meas** to complete the measurement and display the results.

**Cylindrical Offset
Result**

Cylindrical Offset Result	
Result	
PtID :	1
Desc. :	-----
East :	74.218 m
North :	67.533 m
Height:	17.043 m
Radius:	1.576 m
Finish	New

Finish

To record results and return to the main **Offset** screen.

New

To measure a new cylindrical object.

Field	Description
PtID	Defined point ID of the center point.
East	Easting coordinate of the centre point.
North	Northing coordinate of the centre point.
Height	Height of the point measured with the reflector.  This is not the calculated height of the centre point.
Radius	Radius of the cylinder.

Description

This favourite is used for measurements to a point that is not directly visible, using a special hidden point rod.

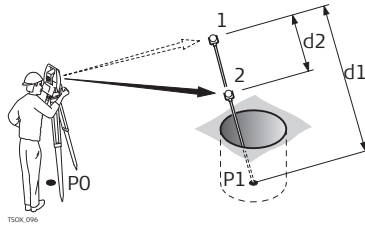

- P0 Instrument station
- P1 Hidden point
- 1-2 Prisms 1 and 2
- d1 Distance between prism 1 and the hidden point
- d2 Distance between prism 1 and 2

Access

1. Press the FNC/Favourites key when within any program.
2. Select  **Hidden Pt** from the **Favourites** Menu.
3. If necessary, press **Rod/EDM** to define the rod or EDM settings.

Hidden Point - Rod Settings

Field	Description
EDM Mode	Changes the EDM Mode.
Prism Type	Changes the prism type.
PrismConst.	Displays the prism constant.
Rod Length	Total length of hidden point rod.
Dist. R1-R2	Spacing between the centres of the prisms R1 and R2.
Meas. Tol.	Limit for the difference between the given and measured spacing of the prisms. If the tolerance value is exceeded, a warning is issued.

Next step

In the **Hidden Point** screen, measure to the first and second prisms using **Meas** and the **Hidden Point Result** screen is displayed.

Hidden Point Result

Displays Easting, Northing and Height coordinates of the hidden point.

Hidden Point Result	
Result	
PtID :	408
Desc. :	-----
East :	22.741 m
North :	11.493 m
Height:	27.886 m
Finish	New

Finish

To record results and return to program where the FNC/Favourites key was selected.

New

To return to the **Hidden Point** screen.



7.4

Check Tie

Description

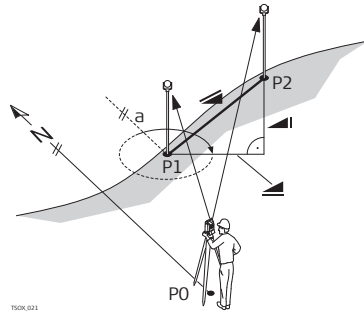
This favourite calculates and displays the slope and horizontal distance, height difference, azimuth, grade, and coordinate differences between the last two measured points. Valid distance measurements are required for the calculation.





- a Azimuth
-  Slope distance
-  Height distance
-  Horizontal distance
- P0 Instrument station
- P1 First point
- P2 Second point

Access

1. Press the FNC/Favourites key when within any program.
2. Select  **CheckTie** from the **Favourites** Menu.

Check Tie

Field	Description
Bearing	Difference in bearing between the two points.
Grade	Difference in gradient between the two points.
	Difference in horizontal distance between the two points.
	Difference in slope distance between the two points.
	Difference in height between the two points.

Messages

The following are important messages or warnings that may appear.

Messages	Description
Two measurements required!	The values cannot be calculated as there are less than two valid measurements.

7.5

EDM Tracking

Access

1. Press the FNC/Favourites key when within any program.
2. Select  **EDM** from the **Favourites** Menu.

Description

This favourite activates or deactivates the tracking measurement mode. The new setting is displayed for about one second and then set. This favourite can only be activated from within the same EDM mode and prism type. The following options are available.

EDM Mode	Tracking mode OFF! <=> Tracking mode ON!
Prism	P-Precise+ <=> P-Tracking / P-Precise & Fast <=> P-Tracking
Non-Prism	NP-Precise <=> NP-Tracking



The last active measurement mode remains set when the instrument is switched off.

Description

This favourite enables the user to remeasure to the point(s) used for Station Setup. This is useful to check if the station position is still correct after measuring some points.

Access

1. Press the FNC/Favourites key when within any program.
 2. Select  **BS-Check** from the **Favourites** Menu.
-

Baksight Check

This screen is exactly the same as the Stakeout screen, except that the available PtIDs are restricted to the points used for the last orientation. Refer to "6.4 Stakeout" for information about the screen.





When setting up a station by local resection, check the coordinate system of the points used from the list.

8 Coding

8.1 Coding

Description Codes contain information about recorded points. With the help of coding, points can be assigned to a particular group simplifying later processing. Codes are stored in codelists, with each codelist supporting a maximum of 200 codes.





Creating a codelist A codelist can be created:

- on the instrument: Select  **Manage** from the Main Menu. Select  from the **Manage** Menu.
- in FlexOffice.

Codelists can be imported and exported via USB memory stick and via FlexOffice. Refer to "10.3 Importing Data" and "10.2 Exporting Data".

GSI coding Codes are always stored as free codes (WI41-49), that means that codes are not directly linked to a point. They are stored before or after the measurement depending on the setting made. A code is always recorded for each measurement as long as the code is displayed in the Code: field. For a code not to be recorded, the Code: field must be cleared. This can be set to occur automatically. Refer to "4.3 Data Settings".

Access

- Either, select  **Q-Survey** from the Main Menu and press **↓ Code** or change to page 4/4 for Black&White display and to page **Code** for Color&Touch display.
- Or, select  **Programs** from the Main Menu, select  **Survey** and press **↓ Code** or change to page 4/4 for Black&White display and to page **Code** for Color&Touch display.
- Or, press the FNC/Favourites key when within any program and select  **Coding**.

Coding

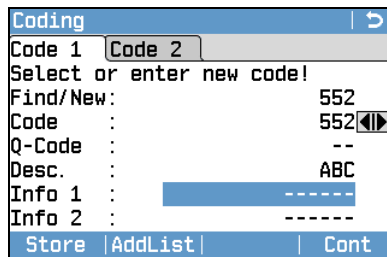

Store

To record the code immediately without measurement.

AddList

To add the entered code to the codelist.

Cont



To record the code with the next measurement.

Field	Description
Find/New	Code name. After entry, the firmware searches for a matching code name, and displays these in the code field. If a matching code name does not exist this value becomes the new code name. It can be added by pressing AddList .
Code	List of existing code names.
Q-Code	Two digit quick code assigned to the code. Refer to "8.2 Quick Coding".
Desc.	Additional remarks.
Info 1 to Info 8	More information lines, freely editable. Used to describe attributes of the code.

- Extend / edit codes** To each code a description and a maximum of 8 attributes with up to 16 characters each can be assigned. Existing code attributes, displayed in fields **Info 1** to **Info 8**, can be overwritten freely with the following exceptions:
The codelist editor of FlexOffice can assign a status to the attributes.
- Attributes with status "fixed" are write-protected. They cannot be overwritten or edited.
 - For attributes with status "Mandatory" an input or a confirmation is required.
 - Attributes with status "Normal" can be edited freely.

8.2 Quick Coding

Description Using quick coding, a predefined code can be called directly via the keypad on the instrument. The code is selected by entering a two-digit number, the measurement is then triggered and the measured data and code saved.
A total of 99 quick codes can be assigned.
The quick code number can be assigned when the code is created in the **Coding** screen, in the Codelist Manager in FlexOffice, or it is assigned in accordance with the order in which the codes were entered, for example, 01 -> first code in the code list ... 10 -> tenth code in the code list.

- Access**
1. Select  **Programs** from the Main Menu.
 2. Select  **Survey** from the **Programs** Menu.
 3. Press **↓ Q-Code**.

- Quick coding step-by-step**
1. Press **↓ Q-Code**.
 2. Enter a two-digit number on the keypad.
 A two-digit code must always be entered on the keypad even if only a one-digit code was assigned.
For example: 4 -> enter 04.
 3. The code is selected, the measurement triggered and the measured data and code saved. The name of the selected code is displayed after the measurement.
 4. Press **↓ Q-Code** again to end quick coding.

Messages The following are important messages or warnings that may appear.



Messages	Description
Cannot edit attribute!	Attribute with fixed status cannot be changed.
No codelist available !	No codelist in memory. Manual input for code and attributes are called automatically.
Code not found!	No code is assigned to the entered number.

FlexOffice Codelists can be easily created and uploaded to the instrument using the supplied FlexOffice software.

9 Tools

9.1 Adjust

Description The **Adjustments** Menu contains tools to be used for the electronic adjustment of the instrument and for setting adjustment reminders. Using these tools helps to maintain the measuring accuracy of the instrument.

- Access**
1. Select  **Tools** from the Main Menu.
 2. Select  **Adjust** from the **Tools** Menu.
 3. Select an Adjustment option from the **Adjustments** screen.

Adjustment options In the **Adjustments** screen, there are several adjustment options.

Menu selection	Description
Hz-Collimation	Refer to "11.3 Adjusting Line-of-Sight and Vertical Index Error".
Vertical Index	Refer to "11.3 Adjusting Line-of-Sight and Vertical Index Error".
Compensator Index	Refer to "11.4 Adjusting the Compensator".
Tilting Axis	Refer to "11.5 Adjusting the Tilting Axis Error".
View Current Adj. Data	Displays the current adjustment values that have been set for Hz-Collimation, V-index and Tilt Axis.
Set Adjustment Reminder	Defines the time period from the last adjustment to when a reminder message should display to do another adjustment. Options are: Never, 2 weeks, 1 month, 3 months, 6 months, 12months. The message will display the next time the instrument is switched on after the time period has been reached.

9.2 Startup Sequence

Description Through the Startup tool, it is possible to record a user-defined sequence of key presses so that, after switching on the instrument, a particular screen can be displayed after the **Level & Plummet** screen instead of the Main Menu. For example, the general **Settings** screen for configuring the instrument settings.

- Access**
1. Select  **Tools** from the Main Menu.
 2. Select  **Startup** from the **Tools** Menu.

- Auto start step-by-step**
1. Press **Record** in the **Startup** screen.
 2. Press **Cont** to confirm the information message and begin the recording process.
 3. The next key presses are stored, up to a maximum of 64. To end the recording press ESC.
 4. If the auto start **Status** is set to **Active**, the stored key presses will be executed automatically after switching on the instrument.





The automatic start sequence has the same effect as pressing the keys manually. Certain instrument settings cannot be made in this way. Relative entries such as automatically setting **EDM Mode: P-Precise & Fast** upon switching on the instrument, are not possible.

Description

The **Info** screen displays instrument, system and firmware information, as well as settings for the date and time.

-  Please provide the instrument-related information, such as instrument type, serial number and equipment number, as well as the firmware version and build number when contacting support.

Access

1. Select  **Tools** from the Main Menu.
2. Select  **Info** from the **Tools** Menu.

Info

Page 1/4 or System

This screen displays information about the instrument and operating system.

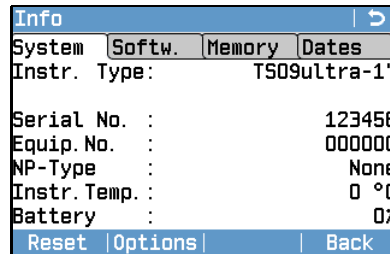

Reset

To reset all settings to the system default.

Options

To display hardware related options.

Page 2/4 or Softw.

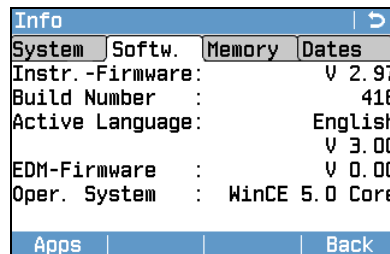



Apps

To display a list of the programs available on the instrument. A check mark is displayed in the check box beside each program that is licenced.

Field	Description
Instr.-Firmware	Displays the firmware version number installed on the instrument.
Build Number	Displays the build number of the firmware.
Active Language	Displays the current language and version number selected for the instrument.
EDM-Firmware	Displays the version number of the EDM firmware.
Oper. System	Display the operating system of the instrument.

Page 3/4 or Memory

Displays job-specific memory information such as the number of stored stations and fixpoints within a job, the number of recorded data blocks, for example measured points, or codes within a job, and the memory space occupied.

-  Before pressing **Format**, to format the internal memory, ensure that all important data is first transferred to a computer. Jobs, formats, codelists, configuration files, uploaded languages and firmware are deleted by formatting.
-  Despite an automatic defragmentation, the memory gets fragmented after a while. Please format the internal memory periodically to maintain the instrument performance.



Page 4/4 or Dates

Field	Description
Maint.-End Date	Displays the end date of the maintenance agreement for the instrument firmware.
Next Service Date	Displays the date of the next service check required. The field can be invisible if turned off by the service reminder.

Description

To fully activate hardware functionality, firmware applications and firmware contracts, licence keys may be required on the instrument. For all instruments, licence keys can be manually entered or uploaded via FlexOffice. For instruments fitted with a Communication side cover licence keys can also be uploaded via a USB memory stick.

Access

1. Select  **Tools** from the Main Menu.
2. Select  **Licence** from the **Tools** Menu.

Enter Licence Key

Field	Description
Method	Method of licence key entry. Either Manual Entry or Upload Key File .
Key	Licence key. Available when Method: Manual Entry .





- Selecting **Delete** from this screen will delete all firmware licence keys on the instrument and the firmware maintenance licence.
When uploading firmware from a USB memory stick, the license key file must be stored in the System folder on the USB memory stick.

Description

The instrument can be protected by a Personal Identification Number. If PIN protection is activated, the instrument will always prompt for a PIN code entry before starting up. If a wrong PIN has been entered five times, a Personal UnblockKey (PUK) code is required. This can be found on the instrument delivery papers.

Activate PIN code step-by-step

1. Select  **Tools** from the Main Menu.
2. Select  **PIN** from the **Tools** Menu.
3. Activate PIN protection by setting **Use PIN-Code: On**.
4. Enter a personal PIN Code (max. 6 numerics) in the **New PIN-Code** field.
5. Accept with **Cont**.



Now the instrument is protected against unauthorised use. After switching on the instrument PIN code entry is necessary.

Lock instrument step-by-step



If PIN protection is activated, it is possible to lock the instrument from within any program without switching off the instrument.

1. Press the FNC/Favourites key when within any program.
2. Select  **PIN-lock** from the **Favourites** Menu.

Entering the PUK code

If a wrong PIN has been entered five times, the system will prompt for a Personal UnblockKey code. The PUK code can be found on the instrument delivery papers. If the PUK code entered is correct then the instrument will start up and reset the PIN code to default value 0 and **Use PIN-Code: Off**.

Deactivate PIN code step-by-step

1. Select  **Tools** from the Main Menu.
2. Select  **PIN-lock** from the **Tools** Menu.
3. Enter the current PIN in **PIN-Code:**.
4. Press **Cont**.
5. Deactivate PIN protection by setting **Use PIN-Code: Off**.
6. Accept with **Cont**.





The instrument is now no longer protected against unauthorised use.

Description

To load program software or an additional language, connect the instrument to FlexOffice via the serial interface and load using "FlexOffice - Software Upload". Refer to the FlexOffice online help for further information.

For instruments fitted with a Communication side cover, the software can be loaded via a USB memory stick. This process is described below.

Access

1. Select  **Tools** from the Main Menu.
2. Select  **Load FW** from the **Tools** Menu.



- Never disconnect the power supply during the system upload process. The battery must be at least 75% capacity before commencing the upload.

Loading firmware and languages step-by-step

-  All firmware and language files must be stored in the system folder to be transferred to the instrument.
1. To load firmware and languages: Select **F1 Firmware,EDM-FW,Logo**. The **Select File!** screen will appear.
To load only languages: Select **F2 Language(s) only** and skip to step 4..
 2. Select the firmware file from the system folder of the USB memory stick.
 3. Press **Cont.**
 4. The **Upload Languages!** screen will appear displaying all language files in the system folder of the USB memory stick. Select **Yes** or **No** for a language file to be uploaded. At least one language must be set to **Yes**.
 5. Press **Cont.**
 6. Once successfully loaded, the system will shut down and restart again automatically.



Access

Select  **Manage** from the Main Menu.

Manage

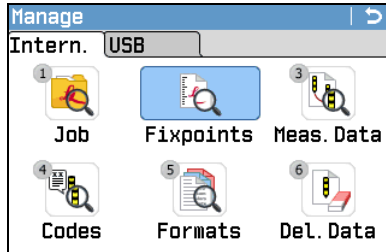
The **Manage** Menu contains all functions for entering, editing, checking and deleting data in the field.



Menu item	Description
Job	To view, create and delete jobs. Jobs are a summary of data of different types, for example, fixed points, measurements or codes. The job definition consists of the job name and user. The system generates time and date at the time of creation.
Fixpoints	To view, create, edit and delete fixpoints. Valid fixed points contain at least the point ID and the coordinates E, N or H.
Meas.Data	To view, edit and delete measurement data. Measurement data available in the internal memory can be searched for via a specific point search, or by viewing all points within a job. The PtID, hr, code and code details can be edited.  If the details of a point have been edited, any new calculations will use the new point details. However, any previously stored calculation results based on the original coordinates of the point will not be updated.
Codes	To view, create, edit and delete codes. To each code a description and a maximum of 8 attributes with up to 16 characters each can be assigned.
Formats	To view and delete data format files.
Del.Data	To delete individual jobs, fixpoints and measurements of a specific job or all jobs in the memory.  Deleting the memory cannot be undone. After confirming the message all data is permanently deleted.
USB-Stick	To view, delete, rename and create folders and files stored on the USB memory stick. Only available if the instrument is fitted with a Communication side cover and a USB memory stick is inserted. Refer to "10.4 Working with a USB Memory Stick" and "Appendix B Directory Structure".

Description

Job data, format files, configuration sets and codelists can be exported from the internal memory of the instrument. Data can be exported via:

The RS232 serial interface

A receiver, such as a laptop, is connected to the RS232 port. The receiver requires FlexOffice or another third-party software.



If the receiver is too slow in processing data the data could be lost. With this type of data transfer the instrument is not informed about the performance of the receiver (no protocol). Therefore the success of this type of transfer is not checked.

The USB device port

For instruments fitted with a Communication side cover.

The USB device can be connected to the USB device port housed in the Communication side cover. The USB device requires FlexOffice or another third-party software.

A USB memory stick



For instruments fitted with a Communication side cover. A USB memory stick can be inserted and removed from the USB host port housed in the Communication side cover. No additional software is required for the transfer.

XML Export

The exporting of XML data has some special requirements.

- XML standards do not allow a mix of imperial and metric measurement systems. When exporting XML data, all measurements will be converted to the same measurement system as set for the distance unit. For example, if the distance unit is set to a metric unit (metre), the pressure and temperature units will be converted to metric units as well, even if they are set to imperial units on the instrument.
- The angle unit MIL is not supported by XML. When exporting XML data, measurements using this unit are converted to dec.deg.
- The distance unit ft-in/16 is not supported by XML. When exporting XML data, measurements using this unit are converted to feet.
- Points with Height coordinates only, are not supported by XML. These points are given the E and N values of 0.

Access

- 1) Select  **Transfer** from the Main Menu.
- 2) Select  **Export**.

Export

Search

To search for jobs or formats within the internal memory.

List

To list all jobs or formats within the internal memory.

Field	Description
To	USB memory stick or RS232 serial interface.
Data Type	Data type to be transferred. To USB memory stick or RS232 serial interface: Measurements, Fixpoints, Meas.& Fixpoints Only to USB memory stick: Road Data, Code, Format, Configuration, Backup
Job	Select whether to export all job-related data or a single job data file.
Select Job	Displays the selected job or road alignment file.
Format	If Data Type: Format . Select whether to export all formats or a single format.
Format Name	If Format: Single Format . Name of the format to be transferred.

Export data step-by-step

1. Press **Cont** in the **Export** screen after selecting the export details.
2. If export is to a USB memory stick, select the desired file location and press **Cont**
 Data type: Default folder on USB memory stick
 Job data: Jobs
 Format files: Formats
 Codes: Codes
3. Select the data format, enter the file name and press **Cont** or **Send**.
 If the data format is ASCII, the **Define ASCII Export** screen appears. Continue with step 4.. For all other data format types, a message will display confirming the successful export of data.

Define the delimiter value, the units and the data fields of the file and press **Cont**. A message will display confirming the successful export of data.



Measurement data are stored in chronological order – line by line - on the instrument. The XML data format and other format files do not output data chronologically but sort the data in separate blocks. During the data export in XML data format or other format files, the instrument has to search the whole memory until the required data is found. Therefore, the data transfer time varies between formats. The GSI data format has the best transfer speed-performance.



A '+', '-', '.' or alphanumeric characters should not be used as delimiter values in ASCII files. These characters can also be part of the point ID or coordinate values and if so, will generate errors where they occur in the ASCII file.



Road Data, Format and **Backup** data types, and the ASCII data format, are only available for data exports to a USB memory stick, not via the RS232 serial interface.



All jobs, formats, codelists and configurations will be stored in the backup folder created on the USB memory stick. The job data will be stored as individual database files for each job, which can then be imported again. Refer to "10.3 Importing Data".

Exportable job data formats

Job data can be exported from a job in dxf, gsi, csv and xml file types, or any other user-defined ASCII format. A format can be defined in FlexOffice Format Manager. Refer to the online help of FlexOffice for information on creating format files.

RS232 example job data output

Within the **Data Type** setting **Measurements**, a data set could be shown as follows:

```

11....+00000D19      21..022+16641826      22..022+09635023
31..00+00006649      58..16+00000344      81..00+00003342
82..00-00005736      83..00+00000091      87..10+00001700
  
```

GSI-IDs			GSI-IDs continued		
11	≐	PtID	41-49	≐	Codes and attributes
21	≐	Horizontal direction	51	≐	ppm [mm]
22	≐	Vertical angle	58	≐	Prism constants
25	≐	Orientation	81-83	≐	(E, N, H) Target point
31	≐	Slope distance	84-86	≐	(E, N, H) Station point
32	≐	Horizontal distance	87	≐	Reflector height
33	≐	Height difference	88	≐	Instrument height

Description



For instruments fitted with a Communication side cover, data can be imported to the internal memory of the instrument via a USB memory stick.

Importable data formats

When importing data, the instrument automatically stores the file in a directory folder based on the file extension. The following data formats can be imported:

Data Type	File extension	Recognised as
GSI	.gsi, .gsi (road)	Fixpoints
DXF	.dxf	Fixpoints
LandXML	.xml	Fixpoints
ASCII	any ASCII file extension e.g. .txt	Fixpoints
Format	.frt	Format file
Codelist	.cls	Codelist file
Configuration	.cfg	Configuration file
Backup	.db	Backup of fixpoints, measurements and configuration

Access

- 1) Select  **Transfer** from the Main Menu.
- 2) Select  **Import**.

Import

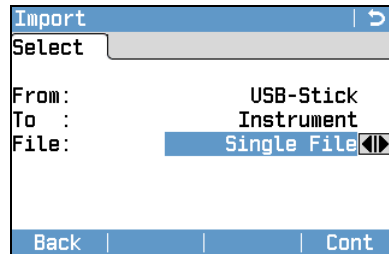

Field	Description
From	USB-Stick
To	Instrument
File	Import a single file or a backup folder.



- Importing a backup folder will overwrite the existing configuration file and code lists on the instrument, and all existing formats and jobs will be deleted.
- A backup can only be imported if the instrument database structure was not changed by a firmware update. If the instrument firmware was updated, it can happen that a backup created before the update cannot be imported. In this case, downgrade the firmware to the previous used version, save the data in the way required and then reload the new firmware.

Import data step-by-step

1. Press **Cont** in the **Import** screen to proceed to the USB memory stick file directory.
2. Select the file or backup folder on the USB memory stick to be imported and press **Cont**.
3. For a file: Define the Job name for the imported file, and, if requested, the file definition and layers, and press **Cont** to import. If a Job with the same name already exists in the internal memory, a message will appear with the options to overwrite the existing job, attach the new points to the current job, or rename the job for the file being imported.

If new points are attached to the current job, and the same point ID already exists, the existing point ID will be renamed with a numerical suffix. For example, PointID23 will be renamed to PointID23_1. The maximum renamed suffix is 10, e.g. PointID23_10.

For a backup folder: Take note of the warning message displayed and press **Cont** to proceed and import the folder.

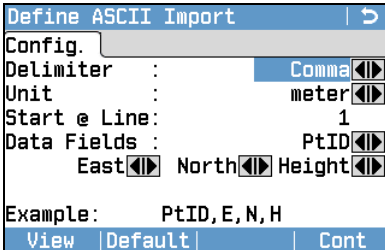
4. 

If the file is an ASCII file, the **Define ASCII Import** screen will appear. Define the delimiter value, the units and the data fields of the file and press **Cont** to continue.

5. A message will display once the file or backup folder has been successfully imported.



A '+', '-', '.' or alphanumeric characters should not be used as delimiter values in ASCII files. These characters can also be part of the point ID or coordinate values and if so, will generate errors where they occur in the ASCII file.

Insert a USB memory stick step-by-step

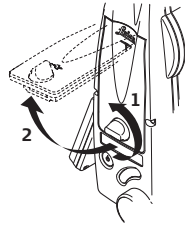

Open the compartment lid on the Communication side cover.

The USB host port is located underneath the top edge of the compartment.

TS06_0174

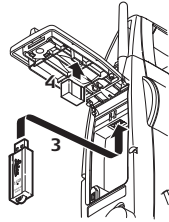

Insert the USB memory stick into the USB host port.

The cap of a Leica industrial grade USB memory stick can be stored on the underside of the compartment lid.

Close the compartment lid and turn the knob to lock the compartment closed.

TS06_0175



Always return to the Main Menu before removing the USB memory stick.



Whilst other USB memory sticks may be used, Leica Geosystems recommends Leica industrial grade USB memory sticks and cannot be held responsible for data loss or any other error that may occur when using a non-Leica USB memory stick.



- Keep the USB memory stick dry.
 - Use it only within the specified temperature range, -40°C to +85°C (-40°F to +185°F).
 - Protect the USB memory stick from direct impacts.
- Failure to follow these instructions could result in data loss and/or permanent damage to the USB memory stick.

Format a USB memory stick step-by-step



Formatting the USB memory stick before starting to store data is required if a completely new USB memory stick is used, or if all existing data needs to be deleted.



The formatting function on the instrument only works for Leica USB memory sticks. All other USB memory sticks should be formatted on a computer.





Despite an automatic defragmentation, the USB memory stick gets fragmented after a while. Please format the USB memory stick periodically to maintain the instrument performance.

1. Select  **Manage** from the Main Menu.
2. Select  **USB-Stick** from the **Manage** Menu.
3. Press **↓ Format** in the **USB-File Manager** screen.
4. A warning message will appear.



By activating the format command all data will be lost. Make sure that all important data on the USB memory stick has been backed up before formatting the USB memory stick.

5. Press **Yes** to format the USB memory stick.
6. A message will display once the formatting of the USB memory stick is completed. Press **Cont** to return to the **USB-File Manager** screen.

Description	Instruments fitted with a Communication side cover can communicate with external devices via a Bluetooth connection. The instrument Bluetooth is a slave only. The Bluetooth of the external device will be the master, and therefore will control the connection and any data transfer.
Establishing a connection step-by-step	<ol style="list-style-type: none"> 1. On the instrument ensure that the communication parameters are set to Bluetooth: and Active. Refer to "4.6 Interface Settings". 2. Activate Bluetooth on the external device. The steps required depend on the Bluetooth driver and other device specific configurations. Refer to the device user manual for information on how to configure and search for a Bluetooth connection. The instrument will appear on the external device as "TS0x_y_zzzzzz", where x = the FlexLine plus series (TS06 plus or TS09 plus), y = the angular accuracy in arc seconds, and z = the serial number of the instrument. For example, TS06_3_1234567. 3. Some devices ask for the identification number of the Bluetooth. The default number for a FlexLine plus Bluetooth is 0000. This can be changed by: <ul style="list-style-type: none"> • Select  Settings from the Main Menu. • Select  Interface from the Settings Menu. • Press BT-PIN from the Interface Settings screen. • Enter a new Bluetooth PIN number in PIN-Code. • Press Cont to confirm the new Bluetooth PIN. 4. When the external Bluetooth device has located the instrument for the first time, a message will display on the instrument stating the name of the external device and requesting confirmation that connection to this device should be allowed. <ul style="list-style-type: none"> • Press Yes to allow, or • Press No to disallow this connection 5. The instrument Bluetooth sends out the instrument name and serial number to the external Bluetooth device. 6. All further steps must be made in accordance to the user manual of the external device.
Transferring data via Bluetooth	<p>Using FlexOffice Data Exchange Manager, data files can be transferred from the instrument to a local folder via the Bluetooth connection. The transfer is made through the serial port configured on the computer as the Bluetooth Serial Port, however, for faster data transfer speeds we recommend using the USB or RS232 connections. For more information about FlexOffice Data Exchange Manager refer to the comprehensive online help.</p> <p>For transferring data using other external devices or software programs, refer to the user manual of the device or software. The FlexLine plus Bluetooth does not establish or manage the data transfer.</p>

Description

The program package FlexOffice is used for the data exchange between the instrument and a computer. It contains several auxiliary programs in order to support the instrument.

Installation on a computer

The installation program can be found on the DVD-ROM supplied. Insert the DVD and follow the on-screen instructions. Please note that FlexOffice can only be installed on computers with MS Windows 2000, XP, Vista and Windows 7 operating systems.



FlexLine plus instruments are supported from FlexOffice v2.2 onwards.



For more information about FlexOffice refer to the comprehensive online help.

11

Check & Adjust

11.1

Overview

Description

Leica Geosystems instruments are manufactured, assembled and adjusted to the best possible quality. Quick temperature changes, shock or stress can cause deviations and decrease the instrument accuracy. It is therefore recommended to check and adjust the instrument from time to time. This check and adjust can be done in the field by running through specific measurement procedures. The procedures are guided and must be followed carefully and precisely as described in the following chapters. Some other instrument errors and mechanical parts can be adjusted mechanically.

Electronic adjustment

The following instrument errors can be checked and adjusted electronically:

- Horizontal collimation error, also called line-of-sight error.
- Vertical index error, and simultaneously the electronic level.
- Compensator longitudinal and transversal index errors
- Tilting axis error.



For determining these errors, it is necessary to measure in both faces, but the procedure can be started in any face.

Mechanical adjustment

The following instrument parts can be adjusted mechanically:

- Circular level on the instrument and tribrach.
- Laser plummet.
- Screws on the tripod.



During the manufacturing process, the instrument errors are carefully determined and set to zero. As mentioned, these errors can change and it is highly recommended to redetermine them in the following situations:

- Before the instrument is used for the first time.
- Before every high precision survey.
- After rough or long periods of transport.
- After long periods of work or storage.
- If the temperature difference between current environment and the temperature at the last calibration is more than 10°C (18°F).

11.2

Preparation



Before determining the instrument errors, level-up the instrument using the electronic level. The **Level & Plummet** is the first screen to appear after turning on the instrument.

The tribrach, the tripod and the ground should be very stable and secure from vibrations or other disturbances.



The instrument should be protected from direct sunlight in order to avoid thermal expansion on one side only.



Before starting to work, the instrument has to become acclimatised to the ambient temperature. Approximately two minutes per °C of temperature difference from storage to working environment, but at least 15 min, should be taken into account.

Line-of-sight error

The line-of-sight error, or horizontal collimation error is the deviation from the perpendicular between the tilting axis and the line of sight. The effect of the line-of-sight error to the horizontal direction increases with the vertical angle.

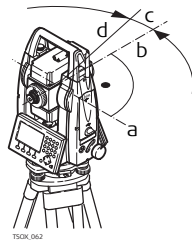

- a) Tilting axis
- b) Line perpendicular to tilting axis
- c) Horizontal collimation, or line-of-sight, error
- d) Line-of-sight

Vertical index error

The vertical circle should read exactly 90° (100 gon) when the line of sight is horizontal. Any deviation from this figure is termed vertical index error. This is a constant error that affects all vertical angle readings.

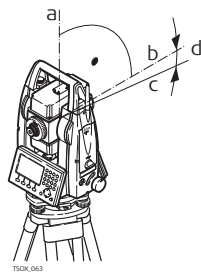



- a) Mechanical vertical axis of the instrument, also called standing axis
- b) Axis perpendicular to the vertical axis. True 90°
- c) Vertical angle is reading 90°
- d) Vertical index error



By determining the vertical index error the electronic level is adjusted automatically

Access

- 1) Select  **Tools** from the Main Menu.
 - 2) Select  **Adjust** from the **Tools** Menu.
- Select:
 - **F1 Hz-Collimation**, or
 - **F2 Vertical Index**.



The procedures and conditions required to correct line-of-sight and vertical index errors are the same, therefore the procedure will only be described once.

Check and adjust step-by-step

1. Level the instrument with the electronic level. Refer to "3 Operation"- "Level up with the electronic level step-by-step".

- 2.

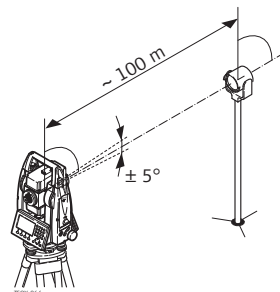

Aim at a point approximately 100 m from the instrument which is within 5° of the horizontal.

3. Press **Store** to measure to the target point.

- 4.

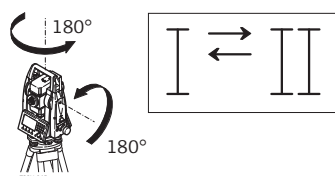

Change face and aim at the target point again

- ☞ For checking the horizontal aim, the difference in Hz and V are displayed.
5. Press **Store** to measure to the target point.
 - ☞ The old and new calculated values are displayed.
 6. Either:
 - Press **More** to measure another set to the same target point. The final adjustment values will be the calculated average from all the measurements.
 - Press **Cont** to save the new adjustment data, or
 - Press ESC to exit without saving the new adjustment data.

Messages

The following are important messages or warnings that may appear.

Messages	Description
V-Angle is not suitable for adjustment or wrong face!	The vertical angle deviates from the required horizontal / line-of-sight, or in face II the vertical angle deviates by more than 5° from the target point. Aim at the target point with an accuracy of min. 5° or, when adjusting the tilt axis, 27° above or beneath the horizontal plane. Confirmation of the message required.
Out of Tolerance! Previous values retained!	Computed values out of tolerance. The previous values are retained and measurements should be repeated. Confirmation of the message required.
Hz-Angle is not suitable for adjustment!	Horizontal angle in face II deviates by more than 5° from the target point. Aim on the target point with an accuracy of min. 5°. Confirmation of the message required.
Timelimit exceeded! Please repeat Adjustment!	Time difference between measurements for results storage exceeds 15 minutes. Repeat the process. Confirmation of the message required.

Compensator index error

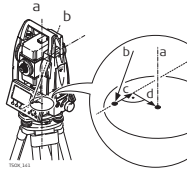

- a) Mechanical vertical axis of the instrument, also called standing axis
- b) Plumb line
- c) Longitudinal component (l) of the compensator index error
- d) Transversal component (t) of the compensator index error



The compensator index errors (l, t) occur, if the vertical axis of the instrument and the plumb line are parallel but the zero points of the compensator and the circular level do not coincide. The calibration procedure electronically adjusts the zero point of the compensator.

A longitudinal component in direction of the telescope and a transversal component perpendicular to the telescope define the plane of the dual axis compensator of the instrument.

The longitudinal compensator index error (l) has a similar effect as the vertical index error and effects all vertical angle readings.

The transversal compensator index error (t) is similar to the tilting axis error. The effect of this error to the horizontal angle readings is 0 at the horizon and increases with steep sightings.

Access

- 1) Select  **Tools** from the Main Menu.
- 2) Select  **Adjust** from the **Tools** Menu.
- 3) Select **F3 Compensator Index**.

Check and adjust step-by-step

Step	Description
1.	Level the instrument with the electronic level. Refer to "3 Operation" - "Level up with the electronic level step-by-step".
2.	Press Store to measure the first face. No target has to be aimed at.
3.	Store to release the measurement in the other face.
	If one or more errors are bigger than the predefined limits, the procedure must be repeated. All measurements of the current run are rejected and are not averaged with the results from previous runs.
4.	Measure the target. The standard deviations of the determined adjustment errors can be calculated from the second run onwards.



Description

The tilting axis error is caused by the deviation between the mechanical tilting axis and the line perpendicular to the vertical axis. This error affects horizontal angles. To determine this error, it is necessary to point to a target located significantly below or above the horizontal plane.



The horizontal collimation error has to be determined before starting this procedure.

Access

- 1) Select  **Tools** from the Main Menu.
- 2) Select  **Adjust** from the **Tools** Menu.
- 3) Select **F4 Tilt Axis**.

Check and adjust step-by-step

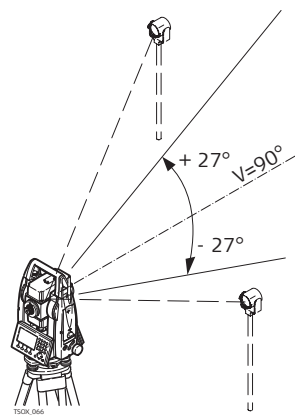

1. Level the instrument with the electronic level. Refer to "3 Operation" - "Level up with the electronic level step-by-step".

2.

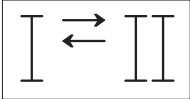

Aim at a point approximately 100 m from the instrument which is at least 27° (30 gon) above or beneath the horizontal plane.

3. Press **Store** to measure to the target point.

4.    Change face and aim at the target point again

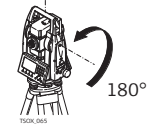

 For checking the horizontal aim, the difference in Hz and V are displayed.

5. Press **Store** to measure to the target point.

 The old and new calculated values are displayed.

6. Either:

- Press **More** to measure another set to the same target point. The final adjustment values will be the calculated average from all the measurements.
- Press **Cont** to save the new adjustment data, or
- Press **ESC** to exit without saving the new adjustment data.

Messages

The same messages or warning as in "11.3 Adjusting Line-of-Sight and Vertical Index Error" may appear.

Adjust the circular level step-by-step

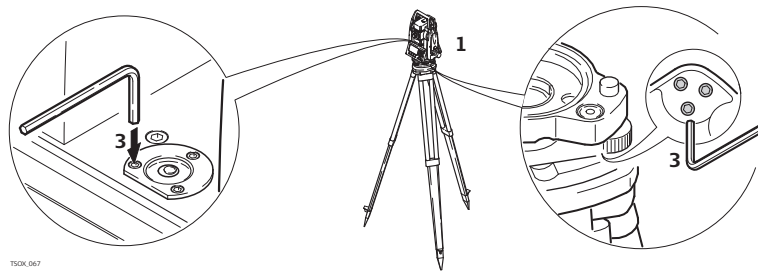

1. Place and secure the tribrach onto the tripod, and then secure the instrument onto the tribrach.
2. Using the tribrach footscrews, level the instrument with the electronic level. To activate the electronic level, turn on the instrument, and, if tilt correction is set to **On**, the **Level & Plummet** screen appears automatically. Alternatively, press the FNC/Favourites key from within any program and select **Level**.
3. The bubbles of the instrument and tribrach levels must be centred. If one or both circular levels are not centred, adjust as follows.
 Instrument: If the bubble extends beyond the circle, use the Allen key supplied to centre it with the adjustment screws.
 Tribrach: If the bubble extends beyond the circle, adjust it using the adjustment pin in conjunction with the adjustment screws. Turn the adjustment screws:
 - To the left: and the bubble approaches the screw.
 - To the right: and the bubble goes away from the screw.
4. Repeat step 3. on the instrument and tribrach until both circular levels are centred and no further adjustments are necessary.



After the adjustment, no adjustment screw should be loose.

11.7

Inspecting the Laser Plummet of the Instrument



The laser plummet is integrated into the vertical axis of the instrument. Under normal conditions of use, the laser plummet does not need adjusting. If an adjustment is necessary due to external influences, the instrument has to be returned to a Leica service department.

Inspect the laser plummet step-by-step

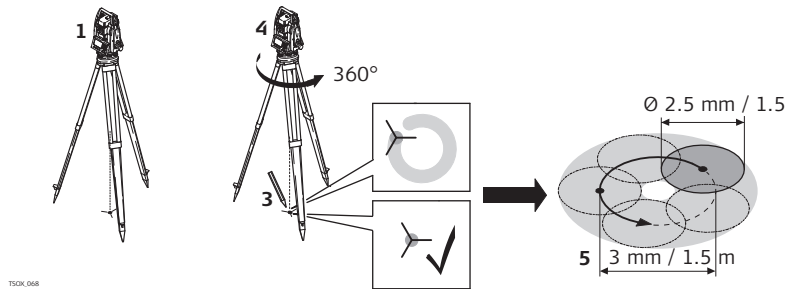

1. Set up the instrument on the tripod approximately 1.5 m above the ground and level up.
2. To activate the laser plummet, turn on the instrument, and, if tilt correction is set to **On**, the laser plummet will be activated automatically, and the **Level & Plummet** screen appears. Otherwise, press the FNC/Favourites key from within any program and select **Level**.
 Inspection of the laser plummet should be carried out on a bright, smooth and horizontal surface, such as a sheet of paper.
3. Mark the centre of the red laser dot on the ground.
4. Turn the instrument slowly through 360°, carefully observing the movement of the red laser dot.
 The maximum diameter of the circular movement described by the centre of the laser dot should not exceed 3 mm at a height of 1.5 m.
5. If the centre of the laser dot makes a clearly circular movement, or moves more than 3 mm away from the point which was first marked, an adjustment may be required. Call your nearest Leica service department.
Depending on brightness and surface type, the size of the laser dot can vary. At a height of 1.5 m an average diameter of 2.5 mm is estimated.

11.8

Servicing the Tripod

Service the tripod step-by-step

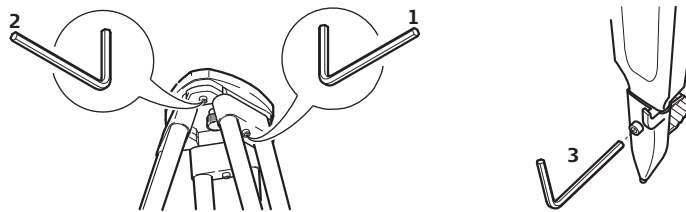

The connections between metal and timber components must always be firm and tight.

- 1) Tighten the leg cap screws moderately with the allen key supplied.
- 2) Tighten the articulated joints on the tripod head just enough to keep the tripod legs open when lifting the tripod off the ground.
- 3) Tighten the screws of the tripod legs.

12

Care and Transport

12.1

Care



Despite an automatic defragmentation, the memory gets fragmented after a while. Please format the internal memory periodically to maintain the instrument performance.

12.2

Transport

Transport in the field

When transporting the equipment in the field, always make sure that you

- either carry the product in its original transport container,
 - or carry the tripod with its legs splayed across your shoulder, keeping the attached product upright.
-

Transport in a road vehicle

Never carry the product loose in a road vehicle, as it can be affected by shock and vibration. Always carry the product in its transport container and secure it.

Shipping

When transporting the product by rail, air or sea, always use the complete original Leica Geosystems packaging, transport container and cardboard box, or its equivalent, to protect against shock and vibration.

Shipping, transport of batteries

When transporting or shipping batteries, the person in charge of the product must ensure that the applicable national and international rules and regulations are observed. Before transportation or shipping, contact your local passenger or freight transport company.

Field adjustment

Periodically carry out test measurements and perform the field adjustments indicated in the User Manual, particularly after the product has been dropped, stored for long periods or transported.

12.3

Storage

Product

Respect the temperature limits when storing the equipment, particularly in summer if the equipment is inside a vehicle. Refer to "14 Technical Data" for information about temperature limits.

Field adjustment

After long periods of storage inspect the field adjustment parameters given in this user manual before using the product.

Li-Ion batteries

- Refer to "14 Technical Data" for information about storage temperature range.
 - Remove batteries from the product and the charger before storing.
 - After storage recharge batteries before using.
 - Protect batteries from damp and wetness. Wet or damp batteries must be dried before storing or use.
 - A storage temperature range of -20°C to +30°C/-4°F to 86°F in a dry environment is recommended to minimise self-discharging of the battery.
 - At the recommended storage temperature range, batteries containing a 50% to 100% charge can be stored for up to one year. After this storage period the batteries must be recharged.
-

Objective, eyepiece and reflectors

- Blow dust off lenses and prisms.
 - Never touch the glass with your fingers.
 - Use only a clean, soft, lint-free cloth for cleaning. If necessary, moisten the cloth with water or pure alcohol. Do not use other liquids; these may attack the polymer components.
-

Fogging of prisms

Prisms that are cooler than the ambient temperature tend to fog. It is not enough simply to wipe them. Keep them for some time inside your jacket or in the vehicle to allow them to adjust to the ambient temperature.

Damp products

Dry the product, the transport container, the foam inserts and the accessories at a temperature not greater than 40°C /104°F and clean them. Remove the battery cover and dry the battery compartment. Do not repack until everything is completely dry. Always close the transport container when using in the field.

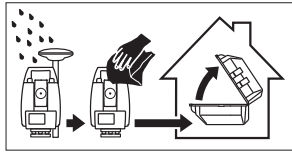
**Cables and plugs**

Keep plugs clean and dry. Blow away any dirt lodged in the plugs of the connecting cables.

13

Safety Directions

13.1

General

Description

The following directions enable the person responsible for the product, and the person who actually uses the equipment, to anticipate and avoid operational hazards.

The person responsible for the product must ensure that all users understand these directions and adhere to them.

13.2

Definition of Use

Intended use

- Measuring horizontal and vertical angles.
 - Measuring distances.
 - Recording measurements.
 - Visualizing the aiming direction and vertical axis.
 - Data communication with external appliances.
 - Computing by means of software.
-

Adverse use

- Use of the product without instruction.
 - Use outside of the intended use and limits.
 - Disabling safety systems.
 - Removal of hazard notices.
 - Opening the product using tools, for example screwdriver, unless this is permitted for certain functions.
 - Modification or conversion of the product.
 - Use after misappropriation.
 - Use of products with recognisable damages or defects.
 - Use with accessories from other manufacturers without the prior explicit approval of Leica Geosystems.
 - Deliberate dazzling of third parties.
 - Controlling of machines, moving objects or similar monitoring application without additional control- and safety installations.
 - Aiming directly into the sun.
 - Inadequate safeguards at the working site.
-

13.3

Limits of Use

Environment

Suitable for use in an atmosphere appropriate for permanent human habitation: not suitable for use in aggressive or explosive environments.



Local safety authorities and safety experts must be contacted before working in hazardous areas, or close to electrical installations or similar situations by the person in charge of the product.

13.4

Responsibilities

Manufacturer of the product

Leica Geosystems AG, CH-9435 Heerbrugg, hereinafter referred to as Leica Geosystems, is responsible for supplying the product, including the user manual and original accessories, in a safe condition.

Person responsible for the product

The person responsible for the product has the following duties:

- To understand the safety instructions on the product and the instructions in the user manual.
- To ensure that it is used in accordance with the instructions.
- To be familiar with local regulations relating to safety and accident prevention.
- To inform Leica Geosystems immediately if the product and the application becomes unsafe.
- To ensure that the national laws, regulations and conditions for the operation of e.g. radio transmitters, lasers are respected.

13.5

Hazards of Use



CAUTION

Watch out for erroneous measurement results if the product has been dropped or has been misused, modified, stored for long periods or transported.

Precautions:

Periodically carry out test measurements and perform the field adjustments indicated in the user manual, particularly after the product has been subjected to abnormal use and before and after important measurements.



DANGER

Because of the risk of electrocution, it is dangerous to use poles and extensions in the vicinity of electrical installations such as power cables or electrical railways.

Precautions:

Keep at a safe distance from electrical installations. If it is essential to work in this environment, first contact the safety authorities responsible for the electrical installations and follow their instructions.



CAUTION

Be careful when pointing the product towards the sun, because the telescope functions as a magnifying glass and can injure your eyes and/or cause damage inside the product.

Precautions:

Do not point the product directly at the sun.



WARNING

During dynamic applications, for example stakeout procedures there is a danger of accidents occurring if the user does not pay attention to the environmental conditions around, for example obstacles, excavations or traffic.

Precautions:

The person responsible for the product must make all users fully aware of the existing dangers.



WARNING

Inadequate securing of the working site can lead to dangerous situations, for example in traffic, on building sites, and at industrial installations.

Precautions:

Always ensure that the working site is adequately secured. Adhere to the regulations governing safety and accident prevention and road traffic.

 CAUTION

If the accessories used with the product are not properly secured and the product is subjected to mechanical shock, for example blows or falling, the product may be damaged or people can sustain injury.

Precautions:

When setting-up the product, make sure that the accessories are correctly adapted, fitted, secured, and locked in position.

Avoid subjecting the product to mechanical stress.

 WARNING

If the product is used with accessories, for example masts, staffs, poles, you may increase the risk of being struck by lightning.

Precautions:

Do not use the product in a thunderstorm.

 CAUTION

During the transport, shipping or disposal of batteries it is possible for inappropriate mechanical influences to constitute a fire hazard.

Precautions:

Before shipping the product or disposing of it, discharge the batteries by running the product until they are flat.

When transporting or shipping batteries, the person in charge of the product must ensure that the applicable national and international rules and regulations are observed. Before transportation or shipping contact your local passenger or freight transport company.

 WARNING

High mechanical stress, high ambient temperatures or immersion into fluids can cause leakage, fire or explosions of the batteries.

Precautions:

Protect the batteries from mechanical influences and high ambient temperatures. Do not drop or immerse batteries into fluids.

 WARNING

If battery terminals are short circuited e.g. by coming in contact with jewellery, keys, metalized paper or other metals, the battery can overheat and cause injury or fire, for example by storing or transporting in pockets.

Precautions:

Make sure that the battery terminals do not come into contact with metallic objects.

 WARNING

If the product is improperly disposed of, the following can happen:

- If polymer parts are burnt, poisonous gases are produced which may impair health.
- If batteries are damaged or are heated strongly, they can explode and cause poisoning, burning, corrosion or environmental contamination.
- By disposing of the product irresponsibly you may enable unauthorised persons to use it in contravention of the regulations, exposing themselves and third parties to the risk of severe injury and rendering the environment liable to contamination.
- Improper disposal of silicone oil may cause environmental contamination.

Precautions:

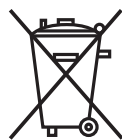

The product must not be disposed with household waste.

Dispose of the product appropriately in accordance with the national regulations in force in your country.

Always prevent access to the product by unauthorised personnel.

Product-specific treatment and waste management information can be downloaded from the Leica Geosystems home page at <http://www.leica-geosystems.com/treatment> or received from your Leica Geosystems dealer.

 WARNING

Only Leica Geosystems authorised service workshops are entitled to repair these products.

13.6
13.6.1

Laser Classification
General

General

The following chapters provide instructions and training information about laser safety according to international standard IEC 60825-1 (2007-03) and technical report IEC TR 60825-14 (2004-02). The information enables the person responsible for the product and the person who actually uses the equipment, to anticipate and avoid operational hazards.

- ☞ According to IEC TR 60825-14 (2004-02), products classified as laser class 1, class 2 and class 3R do not require:
 - laser safety officer involvement,
 - protective clothes and eyewear,
 - special warning signs in the laser working area
 if used and operated as defined in this User Manual due to the low eye hazard level..
- ☞ National laws and local regulations could impose more stringent instructions for the safe use of lasers than IEC 60825-1 (2007-03) and IEC TR 60825-14 (2004-02).

13.6.2

Distancer, Measurements with Reflectors

General

The EDM module built into the product produces a visible laser beam which emerges from the telescope objective.

The laser product described in this section is classified as laser class 1 in accordance with:

- IEC 60825-1 (2007-03): "Safety of laser products"
- EN 60825-1 (2007-10): "Safety of laser products"

These products are safe under reasonably foreseeable conditions of operation and are not harmful to the eyes provided that the products are used and maintained in accordance with this User Manual.

Description	Value
Maximum average radiant power	0.33 mW
Pulse duration	800 ps
Pulse repetition frequency	100 MHz - 150 MHz
Wavelength	650 nm - 690 nm

Labelling

Class 1 Laser Product
according to
IEC 60825-1 (2007 - 03)

..... CE

..... 

.....

Complies with FDA performance standards for laser products except for deviations pursuant to Laser Notice No. 50, dated June 24, 2007.

This device complies with part 15 of the FCC Rules. Operation is subject to the following two conditions:
(1) This device may not cause harmful interference, and
(2) this device must accept any interference received, including interference that may cause undesired operation.

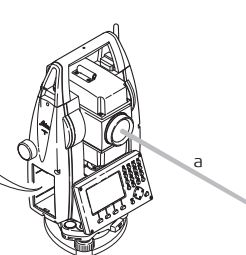

a) Laser beam

General

The EDM module built into the product produces a visible laser beam which emerges from the telescope objective.

The laser product described in this section is classified as laser class 3R in accordance with:

- IEC 60825-1 (2007-03): "Safety of laser products"
- EN 60825-1 (2007-10): "Safety of laser products"

Direct intrabeam viewing may be hazardous (low eye hazard level), in particular for deliberate ocular exposure. The beam may cause dazzle, flash-blindness and after-images, particularly under low ambient light conditions. The risk of injury for laser class 3R products is limited because of:

- a) unintentional exposure would rarely reflect worst case conditions of (e.g.) beam alignment with the pupil, worst case accommodation,
- b) inherent safety margin in the maximum permissible exposure to laser radiation (MPE)
- c) natural aversion behaviour for exposure to bright light for the case of visible radiation.

Description	Value (R500/R1000)
Maximum average radiant power	5.00 mW
Pulse duration	800 ps
Pulse repetition frequency	100 MHz - 150 MHz
Wavelength	650 nm - 690 nm
Beam divergence	0.2 mrad x 0.3 mrad
NOHD (Nominal Ocular Hazard Distance) @ 0.25 s	80 m / 262 ft



From a safety perspective, class 3R laser products should be treated as potentially hazardous.

Precautions:

- 1) Prevent direct eye exposure to the beam.
- 2) Do not direct the beam at other people.



Potential hazards are not only related to direct beams but also to reflected beams aimed at reflecting surfaces such as prisms, windows, mirrors, metallic surfaces, and so on.

Precautions:

- 1) Do not aim at areas that are essentially reflective, such as a mirror, or which could emit unwanted reflections.
- 2) Do not look through or beside the optical sight at prisms or reflecting objects when the laser is switched on, in laser pointer or distance measurement mode. Aiming at prisms is only permitted when looking through the telescope.

Labelling

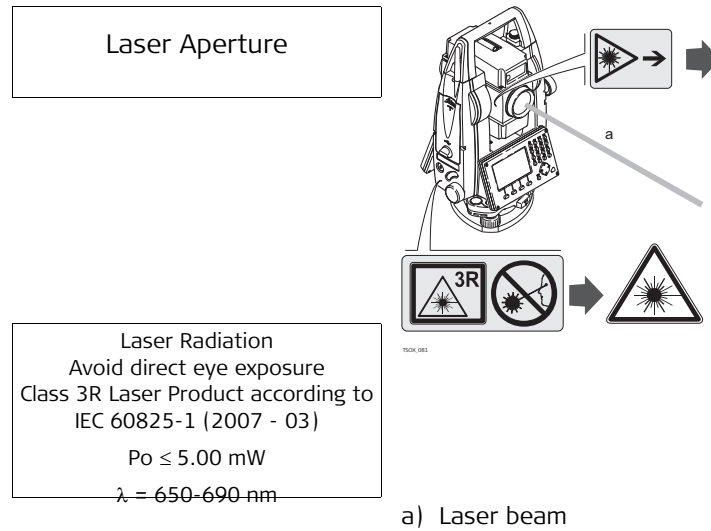

13.6.4

Electronic Guide Light EGL

General

The Electronic Guide Light built into the product produces a visible LED beam which emerges from the front side of the telescope.

☞ The product described in this section, is excluded from the scope of IEC 60825-1 (2007-03): "Safety of laser products".

The product described in this section, is classified as exempt group in accordance with IEC 62471 (2006-07) and does not pose any hazard provided that the product is used and maintained in accordance with this user manual.

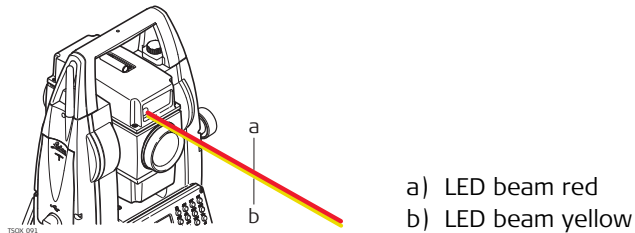

13.6.5

Laser Plummet

General

The laser plummet built into the product produces a visible red laser beam which emerges from the bottom of the product.

The laser product described in this section is classified as laser class 2 in accordance with:

- IEC 60825-1 (2007-03): "Safety of laser products"
- EN 60825-1 (2007-10): "Safety of laser products"

These products are safe for momentary exposures but can be hazardous for deliberate staring into the beam. The beam may cause dazzle, flash-blindness and after-images, particularly under low ambient light conditions.

Description	Value
Maximum average radiant power	0.95 mW
Pulse duration	c.w.
Pulse repetition frequency	c.w.
Wavelength	635 nm

CAUTION

From a safety perspective, class 2 laser products are not inherently safe for the eyes.

Precautions:

- 1) Avoid staring into the beam.
- 2) Avoid pointing the beam at other people.

Labelling

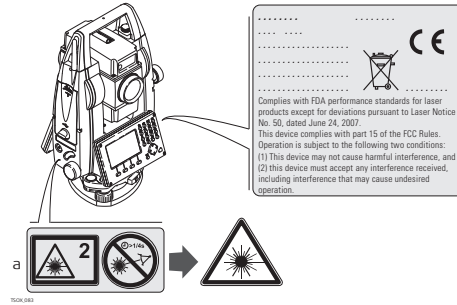

Laser Radiation
Do not stare into the beam
Class 2 Laser Product
according to IEC 60825-1 (2007 - 03)
 $P_o \leq 1.00 \text{ mW}$
 $\lambda = 620 - 690 \text{ nm}$

a) Will be replaced by a class 3R warning label if applicable

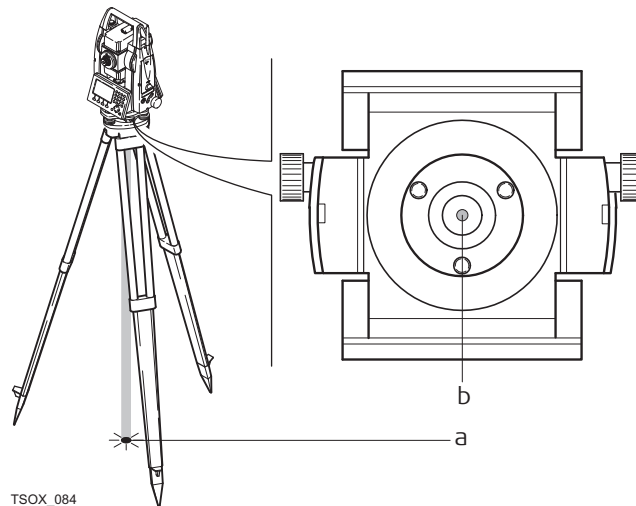

- a) Laser beam
- b) Exit for laser beam

13.7

Electromagnetic Compatibility EMC

Description

The term Electromagnetic Compatibility is taken to mean the capability of the product to function smoothly in an environment where electromagnetic radiation and electrostatic discharges are present, and without causing electromagnetic disturbances to other equipment.

WARNING

Electromagnetic radiation can cause disturbances in other equipment.

Although the product meets the strict regulations and standards which are in force in this respect, Leica Geosystems cannot completely exclude the possibility that other equipment may be disturbed.

 CAUTION

There is a risk that disturbances may be caused in other equipment if the product is used with accessories from other manufacturers, for example field computers, personal computers, two-way radios, non-standard cables or external batteries.

Precautions:

Use only the equipment and accessories recommended by Leica Geosystems. When combined with the product, they meet the strict requirements stipulated by the guidelines and standards. When using computers and two-way radios, pay attention to the information about electromagnetic compatibility provided by the manufacturer.

 CAUTION

Disturbances caused by electromagnetic radiation can result in erroneous measurements.

Although the product meets the strict regulations and standards which are in force in this respect, Leica Geosystems cannot completely exclude the possibility that the product may be disturbed by intense electromagnetic radiation, for example, near radio transmitters, two-way radios or diesel generators.

Precautions:

Check the plausibility of results obtained under these conditions.

 CAUTION

If the product is operated with connecting cables attached at only one of their two ends, for example external supply cables, interface cables, the permitted level of electromagnetic radiation may be exceeded and the correct functioning of other products may be impaired.

Precautions:

While the product is in use, connecting cables, for example product to external battery, product to computer, must be connected at both ends.

Bluetooth

Use of product with Bluetooth:

 WARNING

Electromagnetic radiation can cause disturbances in other equipment, in installations, in medical devices, for example pacemakers or hearing aids and in aircraft. It can also affect humans and animals.

Precautions:

Although the product meets in combination with radio or digital cellular phone devices recommended by Leica Geosystems the strict regulations and standards which are in force in this respect, Leica Geosystems cannot completely exclude the possibility that other equipment may be disturbed or that humans or animals may be affected.

- Do not operate the product with radio or digital cellular phone devices in the vicinity of filling stations or chemical installations, or in other areas where an explosion hazard exists.
 - Do not operate the product with radio or digital cellular phone devices near to medical equipment.
 - Do not operate the product with radio or digital cellular phone devices in aircraft.
-

14

Technical Data

14.1

Angle Measurement

Accuracy

Available angular accuracies	Standard deviation Hz, V, ISO 17123-3	Display resolution			
		["]	[°]	[mgon]	[mil]
1	0.3	0.1	0.0001	0.1	0.01
2	0.6	0.1	0.0001	0.1	0.01
3	1.0	0.1	0.0001	0.1	0.01
5	1.5	0.1	0.0001	0.1	0.01
7	2	0.1	0.0001	0.1	0.01

Characteristics

Absolute, continuous, diametric. Updates each 0.1 to 0.3 s.

14.2

Distance Measurement with Reflectors

Range

Reflector	Range A		Range B		Range C	
	[m]	[ft]	[m]	[ft]	[m]	[ft]
Standard prism (GPR1)	1800	6000	3000	10000	3500	12000
3 prisms (GPR1)	2300	7500	4500	14700	5400	17700
360° prism (GRZ4, GRZ122)	800	2600	1500	5000	2000	7000
Reflector tape 60 mm x 60 mm	150	500	250	800	250	800
Mini prism (GMP101)	800	2600	1200	4000	2000	7000
360° Mini prism (GRZ101)	450	1500	800	2600	1000	3300

Shortest measuring distance: 1.5 m

Atmospheric conditions

Range A: Strong haze, visibility 5 km; or strong sunlight, severe heat shimmer
 Range B: Light haze, visibility about 20 km; or moderate sunlight, slight heat shimmer
 Range C: Overcast, no haze, visibility about 40 km; no heat shimmer

Accuracy

Accuracy refers to measurements to standard reflectors.

EDM measuring mode	Standard deviation ISO 17123-4	Measurement time, typical [s]
P-Precise+	1.5 mm + 2 ppm	2.4
P-Precise & Fast	2 mm + 2 ppm	1.0
P-Tracking	3 mm + 2 ppm	0.3
Tape	5 mm + 2 ppm	2.4

Beam interruptions, severe heat shimmer and moving objects within the beam path can result in deviations of the specified accuracy.

Characteristics

Principle: Phase measurement
 Type: Coaxial, visible red laser
 Carrier wave: 658 nm
 Measuring system: System analyser basis 100 MHz - 150 MHz

Range

Power Pinpoint R500 (without reflector)

Kodak Gray Card	Range D		Range E		Range F	
	[m]	[ft]	[m]	[ft]	[m]	[ft]
White side, 90 % reflective	250	820	400	1312	>500	>1640
Grey side, 18 % reflective	100	330	150	490	>250	>820

Ultra Pinpoint R1000 (without reflector)

Kodak Gray Card	Range D		Range E		Range F	
	[m]	[ft]	[m]	[ft]	[m]	[ft]
White side, 90 % reflective	800	2630	1000	3280	>1000	>3280
Grey side, 18 % reflective	400	1320	500	1640	>500	>1640

Range of Measurement: 1.5 m to 1200 m
 Range of Measurement, FlexPoint: 1.5 m to 30 m
 Display unambiguous: up to 1200 m

Atmospheric conditions

Range D: Object in strong sunlight, severe heat shimmer
 Range E: Object in shade, or overcast
 Range F: Underground, night and twilight

Accuracy

Standard measuring	ISO 17123-4	Measure time, typical [s]	Measure time, maximum [s]
0 m - 500 m	2 mm + 2 ppm	3 - 6	15
>500 m	4 mm + 2 ppm	3 - 6	15

Beam interruptions, severe heat shimmer and moving objects within the beam path can result in deviations of the specified accuracy.

Measurement Mode*	Standard deviation	Measure time, typical [s]
NP-Tracking	5 mm + 3 ppm	0.25

* Accuracy and measure time depend on atmospheric conditions, target object and observation situation.

Characteristics

Type: Coaxial, visible red laser
 Carrier wave: 658 nm
 Measuring system: System analyser basis 100 MHz - 150 MHz

Laser dot size

Distance [m]	Laser dot size, approximately [mm]
at 30	7 x 10
at 50	8 x 20

14.4

Distance Measurement Reflector (>4.0 km)

Range

R500, R1000	Range A		Range B		Range C	
	[m]	[ft]	[m]	[ft]	[m]	[ft]
Standard prism (GPR1)	2200	7300	7500	24600	>10000	>33000
Reflector tape 60 mm x 60 mm	600	2000	1000	3300	1300	4200

Range of measurement: From 1000 m up to 12000 m

Display unambiguous: Up to 12 km

Atmospheric conditions

Range A: Strong haze, visibility 5 km; or strong sunlight, severe heat shimmer

Range B: Light haze, visibility about 20 km; or moderate sunlight, slight heat shimmer

Range C: Overcast, no haze, visibility about 40 km; no heat shimmer

Accuracy

Measurement Mode	ISO 17123-4	Measure time, typical [s]	Measure time, maximum [s]
P-Long (>4.0 km)	5 mm + 2 ppm	2.5	12

Beam interruptions, severe heat shimmer and moving objects within the beam path can result in deviations of the specified accuracy.

Characteristics

Principle: Phase measurement

Type: Coaxial, visible red laser

Carrier wave: 658 nm

Measuring system: System analyser basis 100 MHz - 150 MHz

14.5

Conformity to National Regulations

14.5.1

Products without Communication side cover

Conformity to national regulations



Hereby, Leica Geosystems AG, declares that the instrument is in compliance with the essential requirements and other relevant provisions of applicable European Directives. The declaration of conformity may be consulted at <http://www.leica-geosystems.com/ce>.

Conformity to national regulations

- FCC Part 15 (applicable in US).
- Hereby, Leica Geosystems AG, declares that the instrument with Communication side cover is in compliance with the essential requirements and other relevant provisions of Directive 1999/5/EC and other applicable European Directives. The declaration of conformity may be consulted at <http://www.leica-geosystems.com/ce>.



Class 1 equipment according European Directive 1999/5/EC (R&TTE) can be placed on the market and be put into service without restrictions in any EEA Member state.

- The conformity for countries with other national regulations not covered by the FCC part 15 or European directive 1999/5/EC has to be approved prior to use and operation.

Frequency band

2402 - 2480 MHz

Output power

Bluetooth: 2.5 mW

Antenna

Type: Mono pole
Gain: +2 dBi

Range

Aproximatelly 150 m, >1000 m when using TCPS29
No obstacles, few vehicles or sources of radio emissions/interference in the near vicinity of the instrument, no rain.

Telescope

Magnification: 30 x
 Free Objective aperture: 40 mm
 Focusing: 1.7 m/5.6 ft to infinity
 Field of view: 1°30'/1.66 gon.
 2.7 m at 100 m

Compensation

Quadruple axis compensation (2-axis compensator with Hz-collimation and V-Index).

Angular accuracy ["]	Setting accuracy		Setting range	
	["]	[mgon]	[']	[gon]
1	0.5	0.2	±4	0.07
2	0.5	0.2	±4	0.07
3	1	0.3	±4	0.07
5	1.5	0.5	±4	0.07
7	2	0.7	±4	0.07

Level

Circular level sensitivity: 6'/2 mm
 Electronic level resolution: 2"

Control unit

B&W display: 288 x 160 pixels, LCD, backlit, 8 lines with 31 characters each, heatable (temp. < -5°).
 C&T display: 320 x 240 pixels (QVGA), LCD, backlit, 9 lines with 31 characters each, keyboard illumination

Instrument Ports

Name	Description
RS232	5 pin LEMO-0 for power, communication, data transfer. This port is located at the base of the instrument.
USB host port*	USB memory stick port for data transfer.
USB device port*	Cable connections from USB devices for communication and data transfer.
Bluetooth*	Bluetooth connections for communication and data transfer.

* Only for instruments fitted with a Communication side cover.

Instrument dimensions

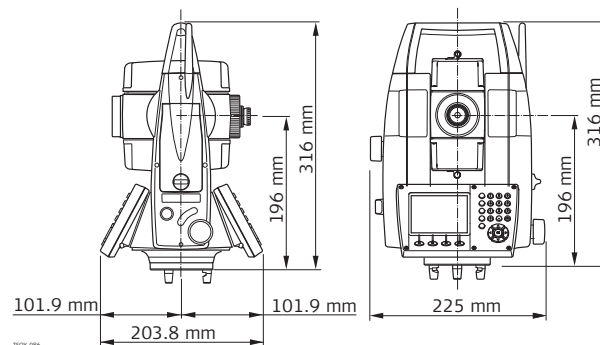

Weight	Instrument:	4.2 kg - 4.5 kg (depending on hardware configuration)
	Tribrach:	760 g
	Battery GEB211:	110 g
	Battery GEB212:	110 g
	Battery GEB221:	210 g
Battery GEB222:	210 g	

Tilting axis height	Without tribrach:	196 mm
	With tribrach (GDF111):	240 mm ±5 mm

Recording

Model	Memory Type	Capacity [MB]	Number of measurements
TS06 plus / TS09 plus	Internal memory	11	60,000

Laser plummet

Type:	Visible red laser class 2
Location:	In standing axis of instrument
Accuracy:	Deviation from plumb line: 1.5 mm (2 sigma) at 1.5 m instrument height
Diameter of laser point:	2.5 mm at 1.5 m instrument height

Power

External supply voltage: (via serial interface)	Nominal voltage 12.8 V DC, Range 11.5 V-14 V
--	--

Internal battery

Type	Battery	Voltage	Capacity	Operating time, typically*
GEB211	Li-Ion	7.4 V	2.2 Ah	~ 10 h
GEB212	Li-Ion	7.4 V	2.6 Ah	~ 12 h
GEB221	Li-Ion	7.4 V	4.4 Ah	~ 20 h
GEB222	Li-Ion	7.4 V	6.0 Ah	~ 30 h

* Based on a single measurement every 30 s at 25°C. Operating time may be shorter if battery is not new.

Environmental specifications

Temperature

Type	Operating temperature		Storage temperature	
	[°C]	[°F]	[°C]	[°F]
All instruments	-20 to +50	-4 to +122	-40 to +70	-40 to +158
Battery	-20 to +50	-4 to +122	-40 to +70	-40 to +158
USB memory stick	-40 to +85	-40 to +185	-50 to +95	-58 to +203

Protection against water, dust and sand

Type	Protection
All instruments	IP55 (IEC 60529)

Humidity

Type	Protection
All instruments	Max 95% non condensing. The effects of condensation are to be effectively counteracted by periodically drying out the instrument.

Arctic model

Operating range:  -35°C to +50°C (-31°F to +122°F)
To minimise unavoidable slowdown of display performance for the Arctic option, switch display heating on and connect the external battery. Allow for a short warm-up time.

Electronic Guide Light EGL

Working range: 5 m to 150 m (15 ft to 500 ft)
Position accuracy: 5 cm at 100 m (1.97" at 330 ft)

Automatic corrections

The following automatic corrections are made:

- Line of sight error
- Tilting axis error
- Earth curvature
- Standing axis tilt
- Vertical index error
- Refraction
- Compensator index error
- Circle eccentricity

Use of scale correction

By entering a scale correction, reductions proportional to distance can be taken into account.

- Atmospheric correction.
- Reduction to mean sea level.
- Projection distortion.

Atmospheric correction

The distance displayed is correct if the scale correction in ppm, mm/km, which has been entered corresponds to the atmospheric conditions prevailing at the time of the measurement.

The atmospheric correction includes:

- Adjustments for air pressure
- Air temperature

For highest precision distance measurements, the atmospheric correction should be determined with:

- An accuracy of 1 ppm
- Air temperature to 1°C
- Air pressure to 3 mbar

Atmospheric corrections °C

Atmospheric corrections in ppm with temperature [°C], air pressure [mb] and height [m] at 60 % relative humidity.

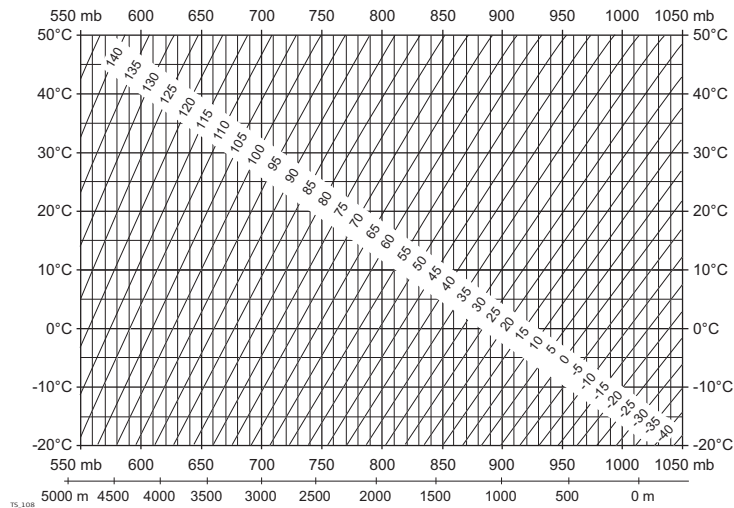

Atmospheric correction °F

Atmospheric corrections in ppm with temperature [°F], air pressure [inch Hg] and height [ft] at 60 % relative humidity.

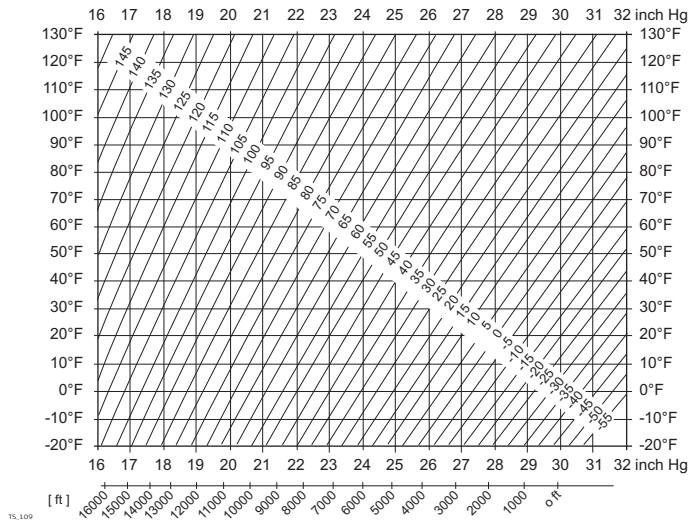

Formulas

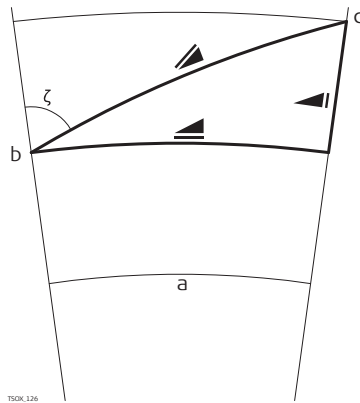

- a Mean Sea Level
- b Instrument
- c Reflector
- ▬ Slope distance
- ▬ Horizontal distance
- ▬ Height difference

The instrument calculates the slope distance, horizontal distance, and height difference in accordance with the following formulas. Earth curvature (1/R) and mean refraction coefficient (k = 0.13) are automatically taken into account when calculating the horizontal distance and height difference. The calculated horizontal distance relates to the station height and not to the reflector height.

Slope distance

$$▬ = D_0 \cdot (1 + \text{ppm} \cdot 10^{-6}) + \text{mm}$$

- ▬ Displayed slope distance [m]
- D0 Uncorrected distance [m]
- ppm Atmospheric scale correction [mm/km]
- mm prism constant [mm]

Horizontal distance

$$▬ = Y - A \cdot X \cdot Y$$

- ▬ Horizontal distance [m]
- Y ▬ * sinζ
- X ▬ * cosζ
- ζ = Vertical circle reading
- A (1 - k/2)/R = 1.47 * 10⁻⁷ [m⁻¹]
- k = 0.13 (mean refraction coefficient)
- R = 6.378 * 10⁶ m (radius of the earth)

Height difference

$$▬ = X + B \cdot Y^2$$

- ▬ Height difference [m]
- Y ▬ * sinζ
- X ▬ * cosζ
- ζ = Vertical circle reading
- B (1 - k)/2R = 6.83 * 10⁻⁸ [m⁻¹]
- k = 0.13 (mean refraction coefficient)
- R = 6.378 * 10⁶ m (radius of the earth)

Software Licence Agreement

This product contains software that is preinstalled on the product, or that is supplied to you on a data carrier medium, or that can be downloaded by you online according to prior authorisation from Leica Geosystems. Such software is protected by copyright and other laws and its use is defined and regulated by the Leica Geosystems Software Licence Agreement, which covers aspects such as, but not limited to, Scope of the Licence, Warranty, Intellectual Property Rights, Limitation of Liability, Exclusion of other Assurances, Governing Law and Place of Jurisdiction. Please make sure, that at any time you fully comply with the terms and conditions of the Leica Geosystems Software Licence Agreement.

Such agreement is provided together with all products and can also be referred to and downloaded at the Leica Geosystems home page at <http://www.leica-geosystems.com/swlicense> or collected from your Leica Geosystems distributor.

You must not install or use the software unless you have read and accepted the terms and conditions of the Leica Geosystems Software Licence Agreement. Installation or use of the software or any part thereof, is deemed to be an acceptance of all the terms and conditions of such Licence Agreement. If you do not agree to all or some of the terms of such Licence Agreement, you must not download, install or use the software and you must return the unused software together with its accompanying documentation and the purchase receipt to the distributor from whom you purchased the product within ten (10) days of purchase to obtain a full refund of the purchase price.

Instrument axis

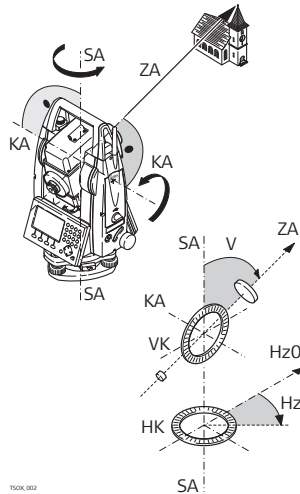

ZA = Line of sight / collimation axis
 Telescope axis = line from the reticle to the center of the objective.
 SA = Standing axis
 Vertical rotation axis of the telescope.
 KA = Tilting axis
 Horizontal rotation axis of the telescope. Also known as the Trunion axis.
 V = Vertical angle / zenith angle
 VK = Vertical circle
 With coded circular division for reading the vertical angle.
 Hz = Horizontal direction
 HK = Horizontal circle
 With coded circular division for reading the horizontal angle.

Plumb line / compensator



Direction of gravity. The compensator defines the plumb line within the instrument.

Standing axis inclination



Angle between plumb line and standing axis. Standing axis tilt is not an instrument error and is not eliminated by measuring in both faces. Any possible influence it may have on the horizontal direction or vertical angle is eliminated by the dual axis compensator.

Zenith

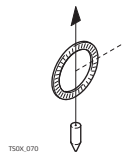

Point on the plumb line above the observer.

Reticle

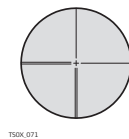

Glass plate within the telescope with reticle.

Line-of-sight error (horizontal collimation)

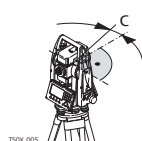

The line-of-sight error (c) is the deviation from the perpendicular between the tilting axis and line of sight. This could be eliminated by measuring in both faces.

Vertical index error

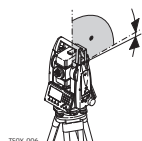

With a horizontal line of sight the vertical circle reading should be exactly 90° (100 gon). The deviation from this value is termed the Vertical index error (i).

Tilting axis error

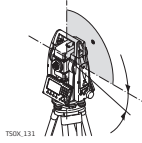

The tilting axis error is the deviation within the horizontal rotation axis, between measurements in both faces.

Explanation of displayed data

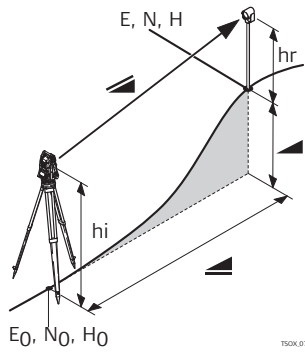

- ▲ Indicated meteorological corrected slope distance between instrument tilting axis and center of prism/laser dot
- ▲ Indicated meteorological corrected horizontal distance
- ▲ Height difference between station and target point
- hr Reflector height above ground
- hi Instrument height above ground
- E0, N0, H0 Easting, Northing and Height coordinates of station
- E, N, H Easting, Northing and Height coordinates of target point

Appendix A Menu Tree



Depending on local firmware versions the menu items may differ.

Menu Tree

- Q-Survey
- Programs
 - Station Setup
 - Survey
 - Stakeout
 - Tie Distance
 - COGO
 - Area & DTM Volume
 - Remote Height
 - Traverse
 - Reference Line
 - Reference Arc
 - Reference Plane
 - Road 2D
 - Road 3D
- Manage
 - Job
 - Fixpoints
 - Meas.Data
 - Codes
 - Formats
 - Del.Data
 - USB-Stick
- Transfer
 - Export
 - Import
- Settings
 - Work
 - Trigger Key1, Trigger Key2, USER Key 1, USER Key 2, Tilt Corr., Hz Corr., Face I Def.
 - Regional
 - Hz Increment, V-Setting, V After DIST, Language, Lang.Choice, Angle Unit, Min. Reading, Dist. Unit, Dist.Decimal, Temp. Unit, Press.Unit, Grade Unit, Time (24h), Date, Format
 - Data
 - Double PtID, Sort Type, Sort Order, Code Record, Code, Data Output, GSI-Format, GSI-Mask
 - Screen...
 - Display Ill., Keyb. Ill.**, Reticle Ill., Contrast*, Displ.Heater*, Touch Screen**, Auto-Off, Screensaver, Beep, Sector Beep, Stakeout Beep
 - EDM
 - EDM Mode, Prism Type, Leica Const., Abs. Const., Laser-Point, Guide Light
 - Interface
 - Port :, Bluetooth:, Baud rate:, Data bits:, Parity :, Endmark :, Stop bits: 1, Acknowlge:
- Tools
 - Adjust
 - F1 Hz-Collimation, F2 Vertical Index, F3 Compensator Index, F4 Tilt Axis, F1 View Adjustment Data, F2 Adjustment Reminder
 - Startup
 - Info

Instr. Type, Serial No., Equip.No., NP-Type, Instr.Temp., Battery, Instr.-Firmware, Build Number, Active Language, EDM-Firmware, Oper. System, Job, Stations, Fixpoints, Meas.Records, Occupied Memory, Maint.-End Date, Next Service Date

- | |--- Licence
- | |--- PIN
 Use PIN-Code, New PIN-Code
- | |--- Load FW
 F1 Firmware,EDM-FW,Logo, F2 Language(s) only

* Valid for Black&White displays only

** Valid for Color&Touch displays only

Appendix B Directory Structure

Description

On the USB memory stick, files are stored in certain directories. The following diagram is the default directory structure.

Directory Structure

— CODES	• Codelists (*.cls)
— FORMATS	• Format files (*.fmt)
— JOBS	• GSI, DXF, ASCII and LandXML files (*.*)
	• Logfiles created from programs
— SYSTEM	• Firmware files (FlexField.fw and FlexField_EDM.fw)
	• Language files (FlexField_Lang_xx.fw)
	• Licence file (*.key)
	• Configuration files (*.cfg)

A	
Accuracy	
Angle measurement	134
Non-Prism mode	135
Prism (>4.0 km)	136
Prism mode	134
Activate touch screen	92
Adjustment	
Adjustment reminder	101
Combined adjustment	117
Compensator	119
Electronic	116, 117, 119
Errors, view current	101
Inspecting laser plummet	122
Line of sight	117
Mechanical	116
Of circular level on instrument	121
Of circular level on tribrach	121
Preparation	116
Tilt axis	120
Vertical index	117
Alignments	
Creating or uploading	77
Description of	73
Angle measurement	134
Angle unit, setting of	26
Angular unit	92
Arctic instrument	140
Area and DTM Volume, program	63
Atmospheric data, setting of	33
Auto detect, icon	13
Auto-Off, setting of	29
B	
Backsight check	92, 98
Base line	48
Battery	
Changing of	20
Charging	19
First-time use	19
Icon	13
Labelling	133
Technical Data	139
Baudrate	34
Beep for stakeout, settings of	30, 47
Beep, setting of	29
Bluetooth	
Antenna	137
Communication parameters	34
Connection	114
Data transfer	114
Icon	13
Output power	137
PIN	34
Safety directions	132
C	
Calibrate touch screen	29
Care	123
Check & Adjust	116
Check backsight	92
Check Tie	97
Checking tie	92
Circular level, adjustment of	121
Cleaning and Drying	124
Codelist, creation	99
Coding	99
Data management	107
Editing / Extending	100
Free coding	92
GSI coding	99
Quick code	100
COGO, program	67
Collimation axis	145
Communication parameters	34
Communication side cover	
Description	10
Frequency band	137
Technical data	137
Compensation	138
Compensator	
Index error	119
Compensator adjustment	119
Compensator, icon	13
Configuration, setting of	24
Connecting Bluetooth	114
Constants, prism	32
Container contents	9
Contrast, setting of	29
Corrections	
Atmospheric	141
Automatic	140
Scale	141
Creating a codelist	99
Cut situation, slopes	76, 81
Cylindrical Offset	94
D	
Data	
Storage	20
Transfer	108
Data formats	111

Data management	107
Data output, setting location of	28
Databits	34
Date	27
Deactivate touch screen	92
Definition of Use	125
Del. Rec	92
Delete job memory	107
Delete last record	92
Dimensions, of instrument	138
Directory structure	149
Display heater, setting of	29
Display illumination, setting of	29
Display, technical details of	138
Distance decimal places, setting of	27
Distance unit	92
Distance unit, setting of	26
Double point, setting of	28
DTM Volume, application	63
E	
Edit fields, how to	15
EDM signal reflection	92
EDM tracking mode on/off	92
Electromagnetic compatibility EMC	131
Electronic adjustment	116
Electronic Distance Measurement EDM	
Guidelines for correct results	22
Laser pointer	32
Non-Prism mode	135
Prism (>4.0 km)	136
Prism constant	32
Prism mode	134
Prism Types	31
Settings	31
Signal reflection	33
Tracking	97
Electronic Guide Light EGL	
Guide Light settings	32
Safety directions	130
Technical data	140
Electronic level, level up instrument	18
Endmark	34
Export data	108
F	
Face, setting of	24
FCC Statement	133
Fields, common	39
File extensions	111, 111
Fill situation, slopes	76, 82
Fixpoint data	107
FlexField firmware	8
FlexOffice	
Description	8
Folder structure	149
Formats, management of	107
Formatting	
Internal memory	102
USB Stick	113
Free coding	99
Functions	
Access	92
FNC/Favourites key	11
Functions FNC	
Description of	92
G	
Glossary	145
Grade unit, setting of	27
GSI	
Coding	99
Output mask, setting of	28
Output format, setting of	28
H	
Height transfer	92
Helmert resection	40
Hidden Point	96
Hidden point, function	92
Horizontal alignment	73
Horizontal angle, setting of	25
H-Trans	92
Hz corrections, setting of	24
Hz increment	25
I	
Icons	12
Identifier, setting location of	47
Import data	111
Individual PPM, setting of	33
Instrument	
Components	10
Configuration	24
Dimensions	138
Level up	18
Ports	138
Protection with PIN	105
Settings	24
Setup	17
Technical Data	138
Instrument components	10
Instrument information	102
Interface settings	34
Intersections, COGO application	68
Inverse and traverse, COGO application	67

J	
Job, management of	107
K	
Keyboard	11
Keyboard illumination, settings of	29
Keys	11
L	
Labelling	128, 130, 131, 133, 133
Language	
Selection of	14
Setting of	26
Setting of choice	26
Upload language	106
Laser	
Classification	128
Laser plummet	18
Adjust intensity	19
Inspect	122
Safety directions	130
Technical data	139
Laser pointer	
On/Off	92
Setting of	32
Laserpt.	92
Level	138
Level & Plummet screen, access	92
Licence keys, entry of	104
Li-Ion battery	
Storage	123
Limits of use	125
Line extension, COGO application	69
Line of sight	145
Adjustment	117
Local resection	40
Lock instrument	105
Lock with PIN	92
M	
Main menu	21
Maintenance, end date	103
Manage	107
Manual, validity of	2
Measurement data	107
Mechanical adjustment	116
Memory statistics, management of	102
Menu tree	147
Minimum reading, setting of	26
N	
Navigation key	11
Non-Prism measurements	22
Non-Prism/Prism Toggle	92
O	
Offset definition	92
Offsets, COGO application	69
Operating concept	8
Operating temperature	139
Operation, of instrument	17
Orientation with angle	40
P	
P<->NP	92
Parity	34
PIN	92
Bluetooth PIN	114
Instrument PIN	105
Plumb line	145
Point search	15
Points	
Multiple points with same ID	28
Ports	
Communication parameters	34
Instrument ports	138
ppm handling	33
PPM, setting of	33
Pressure unit, setting of	27
Prism	
Absolute constant	32
Icons	12
Leica constant	32
Type	31
Prism measurements	23
Programs	
Area and DTM Volume	63
COGO	67
Reference Arc	56
Reference Line	48
Reference Plane	60
Remote Height	66
Road 2D	70
Road 3D	72
Station Setup	39
Surveying	45
Traverse	84
Programs - Getting Started	36
Pre-settings for programs	37
Set accuracy limit	40
Set Job	37
Set Tolerances	85
Station Setup	38
Projection scale, setting of	33
PUK code, use of	105
Q	
Q-Code	100

Quadruple-axis compensation	138	Station Setup, program	39
Quick coding	100	Stopbits	34
R			
Recording code, setting of	28	Storage	123
Reduction Formulas	143	Storage temperature	139
Reference Arc, program	56	Surveying, program	45
Reference Line, program	48	Symbols in graphics	16
Reference Plane, program	60	T	
Refraction coefficient	143, 143	Target Offset	93
Remote Height, program	66	Technical data	134
Remote point	66	Technical Data	
Resection	40	Internal battery	139
Resection, Helmert	40	Telescope	138
Resection, local	40	Temperature	
Responsibilities	126	Battery	139
Reticle	145	Instrument	139
Reticle illumination, setting of	29	USB stick	139
Road 2D, program	70	Temperature unit, setting of	27
Road 3D, program	72	Terminology	145
Road Projects, elements of	73	Tilt and horizontal corrections	24
Rod Length	96	Tilt Axis, adjustment	120
RS232		Tilt correction, setting of	24
Communication parameters	34	Tilting axis, description of	146
Icon	13	Time	27
S			
Safety Directions	125	Tools	
Screen	12	Adjust	101
Screensaver, settings of	29	Info	102
Search	15	Licence keys	104
Sector beep, setting of	30	Load Software	106
Serial interface, plug connections	35	Touch screen, activate/deactivate	92
Set job	37	Tracking, EDM	97
Set tolerances	85	Transport	123
Settings, audio	29	Traverse	
Settings, configuration of work	24	Program	84
Settings, data	28	With known azimuth	86
Settings, regional	25	With known backsight	86
Settings, screen	29	Without known backsight	86
Setup		Trigger key	
Instrument	17	Description	12
Tripod	17	Setting of	24
Signal reflection value of EDM	92	Tripod	
Slope elements, description of	76	Service	122
Slope grade	81	Setup	17
Slope types	80	U	
Softkeys	14	Units, settings of	26
Software		Upload languages	106
Loading	106	Upload licence key	104
Software Licence Agreement	144	Upload software	106
Standing axis	145	USB	
Startup sequence, auto start	101	Directory Structure	149
Station Setup	38	File Manager	107
		Formatting	113

Icon	13
Inserting	113
User Interface	11
USER key, setting of	24

V

V After Dist	26
Vertical alignment	73
Vertical angle	
Description	145
Setting of	25
Vertical index	
Adjustment	117
Description	145

W

Weight	139
Wildcard search	15

Z

Zenith	25, 145
Zenith angle	145

Total Quality Management: Our commitment to total customer satisfaction.



Leica Geosystems AG, Heerbrugg, Switzerland, has been certified as being equipped with a quality system which meets the International Standards of Quality Management and Quality Systems (ISO standard 9001) and Environmental Management Systems (ISO standard 14001).

Ask your local Leica Geosystems dealer for more information about our TQM program.

797516-1.0.0en

Original text

Published in Switzerland

© 2012 Leica Geosystems AG, Heerbrugg, Switzerland

Leica Geosystems AG
Heinrich-Wild-Strasse
CH-9435 Heerbrugg
Switzerland
Phone +41 71 727 31 31
www.leica-geosystems.com

- when it has to be **right**

Leica
Geosystems